

2360 Boswell Road
Chula Vista, CA 91914
Phone 619.216.1444
Fax 619.216.1474
E-Mail tech@explorerprocomp.com



PRO COMP SUSPENSION

Suspension Systems that Work!

**PN# 64660K
2005-2011
Nissan Frontier/
Xterra
2009-2010 Suzuki
Equator
2WD/4WD
2 1/2" Front &
1 1/2" Rear Spacer Kit**

This document contains very important information that includes warranty information and instructions for resolving problems you may encounter. Please keep it in the vehicle as a permanent record.

Part #	Description	Qty.
94-8146m	STRUT SPACER	2
90-6317m	HARDWARE PACK: Strut Spacer	1
.100FNFLZ	10mm-1.25 SERRATED FLANGE NUT	6
90-6346m	HARDWARE PACK: Front Bump Stops	2
	CONE BUMPSTOP	2
94-7150	REAR SHACKLE	2
94-7154	SHACKLE PLATE	2
90-6623m	HARDWARE PACK: Upper Ball Joint	1
15N200PCOZ	5/32" X 2" COTTER PIN ZINC	4
12N150PCOZ	1/8" X 1 1/2" COTTER PIN ZINC	4
90-6410m	HARDWARE PACK: Cam Pack	1
73-01410940	14mm HARDENED FLAT WASHER	8
72-01415008812	14mm- 1.5 NUT	4
90-3245	NOTCHED CAM	4
90-3246	CAM BOLT	4
90-6795	HARDWARE PACK: Rear Shackle	1
70-0505751800	1/2" x 5 3/4" HEX BOLT Gr. 8	2
70-0504501800	1/2" x 4 1/2" HEX BOLT Gr. 8	2
72-05000100512	1/2" NYLOCK NUT	4
73-05000034	1/2" USS WASHER	8

NOTE: All part images may vary from catalog and instructions.

<u>RECOMMENDED PRO COMP SHOCKS</u>		
	<u>2005-2011 Frontier 4wd</u>	<u>2005-2011 Frontier 2wd</u>
Front Strut:	N/A	N/A
ES9000 (rear):	921508	921508
MX-6 (rear):	MX6061	MX6061

NOTE: Whenever you make changes to you suspension Pro Comp recommends that you have your alignment checked and your headlights adjusted.

PLEASE NOTE:

Due to differences in manufacturing, dimensions and inflated measurements, tire and wheel combinations should be test fit prior to installation. Tire and wheel choice is crucial in assuring proper fit, performance, and the safety of your Pro Comp equipped vehicle. For this application, we recommend no larger than a 265/75 R16 tire on the factory wheel. The use 285/75 R16 may require major/minor trimming. Additionally, quality tire of radial design wide is also recommended. Violation of these recommendations will not be endorsed as acceptable by Pro Comp Suspension and will void any and all warranties either written or implied.

Introduction:

- ◆ This installation requires a professional mechanic!
- ◆ We recommend that you have access to a factory service manual for your vehicle to assist in the disassembly and reassembly of your vehicle. It contains a wealth of detailed information.
- ◆ Prior to installation, carefully inspect the vehicle's steering and driveline systems paying close attention to the tie rod ends, ball joints, wheel bearing preload, pitman and idler arm. Additionally, check steering-to-frame and suspension-to-frame attaching points for stress cracks. The overall vehicle must be in excellent working condition. Repair or replace all worn or damaged parts!
- ◆ Read the instructions carefully and study the illustrations before attempting installation! You may save yourself a lot of extra work.
- ◆ Check the parts and hardware against the parts list to assure that your kit is complete. Separating parts according to the areas where they will be used and placing the hardware with the brackets before you begin will save installation time.
- ◆ Check the special equipment list and ensure the availability of these tools.
- ◆ Secure and properly block vehicle prior to beginning installation.
- ◆ **ALWAYS** wear safety glasses when using power tools or working under the vehicle!
- ◆ Use caution when cutting is required under the vehicle. The factory undercoating is flammable. Take appropriate precautions. Have a fire extinguisher close at hand.
- ◆ Foot pound torque readings are listed on the Torque Specifications chart at the end of the instructions. These are to be used unless specifically directed otherwise. Apply thread lock retaining compound where specified.
- ◆ **Please note that while every effort is made to ensure that the installation of your Pro Comp lift kit is a positive experience, variations in construction and assembly in the vehicle manufacturing process will virtually ensure that some parts may seem difficult to install. Additionally, the current trend in manufacturing of vehicles results in a frame that is highly flexible and may shift slightly on disassembly prior to installation. The use of pry bars and tapered punches for alignment is considered normal and usually does not indicate a faulty product. However, if you are uncertain about some aspect of the installation process, please feel free to call our tech support department at the number listed on the cover page. We do not recommend that you modify the Pro Comp parts in any way as this will void any warranty expressed or implied by the Pro Comp Suspension company.**

FRONT INSTALLATION:

1. Measure the vehicle from the center of the hub to the fender lip and record this measurement below.

LF: _____ RF: _____

LR: _____ RR: _____

2. Be sure you are working on a level surface. Block the rear tires and raise the front of the vehicle. Support the frame with jack stands. Use floor jacks to support the axle so it can be lifted and lowered relative to the vehicle.
3. Remove the front wheels.



4. Unbolt the sway bar end links from the lower control arm. Save the hardware for reuse.

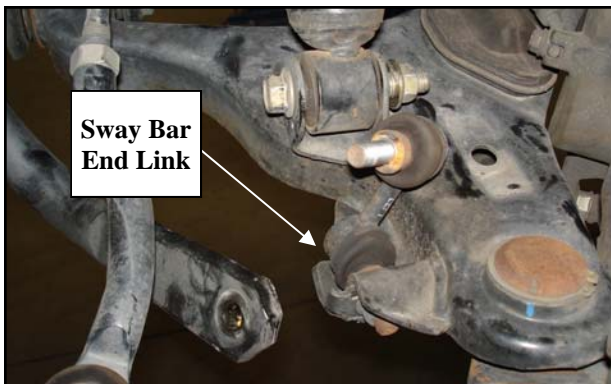

5. Unbolt the ABS line from the back of the spindle.
6. Starting on the driver's side, remove the lower strut bolt from the lower control arm.

NOTE: *The direction of the bolt for reinstallation.*

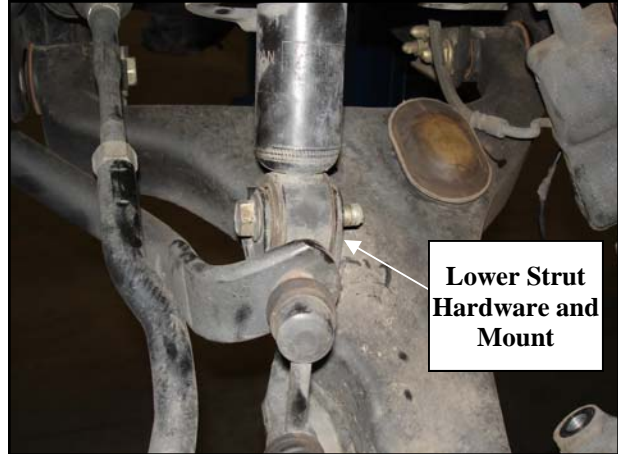

6. Remove the cotter pins and loosen, but do not remove the upper ball joint nut.

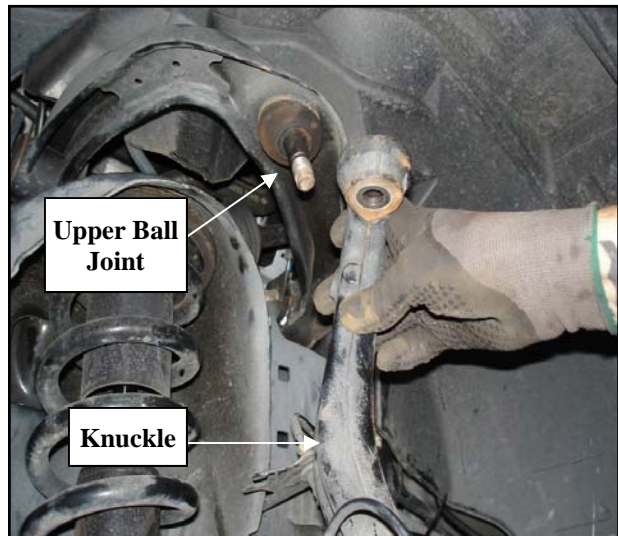

7. Separate the upper ball joint taper from the spindle.
8. Support the lower control arm, remove the upper ball joint nut and lower the lower control arm.
9. Remove the upper strut nut on the strut

tower (3) on each side of the vehicle that holds the strut assembly to the strut tower.

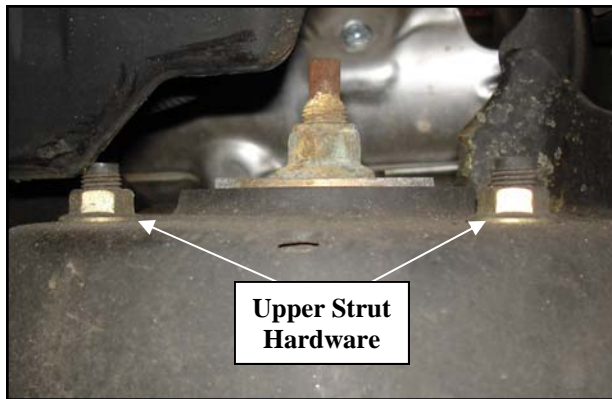

10. Remove the strut assembly from the vehicle and install securely in a bench vise.
11. Locate the existing hole in the upper A-Arm and drill a 3/8" hole on the bottom side as shown in the picture below.

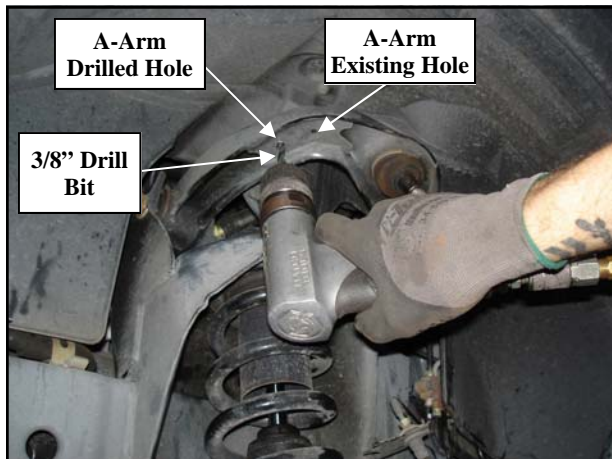

12. Install the bump stop into the newly drilled hole with the long sloped side facing toward the outside of the vehicle.

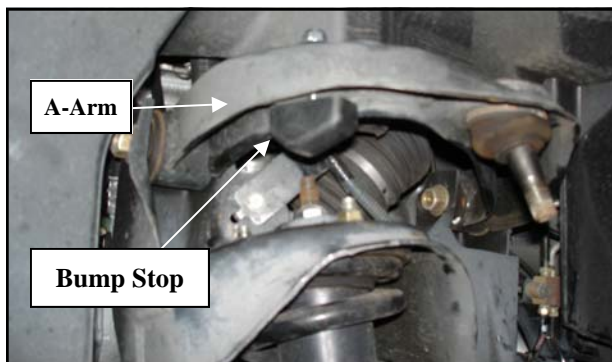

13. Now would be a good time to inspect the front struts for damage or fluid leakage. Replace if necessary.

NOTE: For improved performance Pro Comp struts/shocks are recommended. See the box on page 2 for applications.

14. Install the strut spacer (94-8146m) onto the OE strut and secure using the previously removed OE hardware.

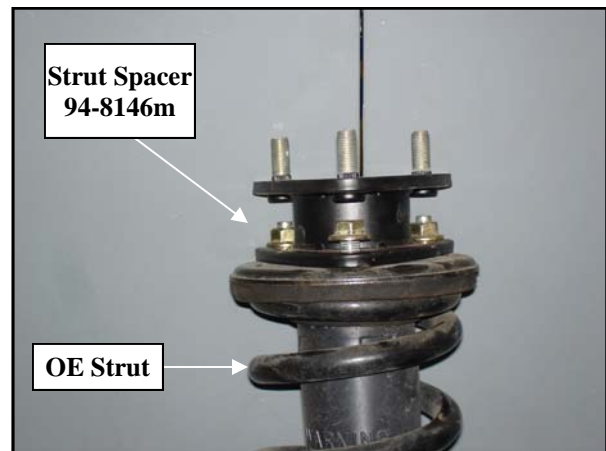

15. Install the strut assembly into the strut tower and secure using the upper (3) 10mm flange nuts. (Make sure the bottom of the strut is aligned properly)
16. Using the floor jack, raise the lower control arm and reinstall. Torque the upper ball joint nut to manufacturer's specification and install the new cotter pin.
17. Torque all of the strut hardware to factory specifications.
18. Repeat steps 4 through 17 on the remaining side of the vehicle.
19. Install the front tires/wheels and lower the vehicle onto the ground. torque the lug nuts according to manufacturer's specifications.
20. Reinstall the sway bar end links to the lower a-arm using the previously removed OE hardware.

21. Recheck all previously loosened hardware.
22. Torque all bolts to factory specifications.
Re-torque all bolts after 500 miles.

IMPORTANT! BE SURE TO BRING THE VEHICLE IMMEDIATELY TO A REPUTABLE ALIGNMENT SHOP TO BE ALIGNED!

NOTES:

- ⇒ **On completion of the installation, have the suspension and headlights re-aligned.**
- ⇒ **After 100 miles recheck for proper torque on all newly installed hardware.**
- ⇒ **Recheck all hardware for tightness after off road use.**

REAR INSTALLATION:

1. Block the front tires and raise the rear of the vehicle. Support the frame with jack stands forward of the rear springs.
2. Remove the rear wheels.
3. Lower and remove the spare tire from the vehicle.
4. Support the rear axle with a floor jack and unbolt the (2) nuts on the rear leaf spring shackle. Remove the (2) nuts and remove the side plate.



5. Remove the rear shackle from the vehicle.

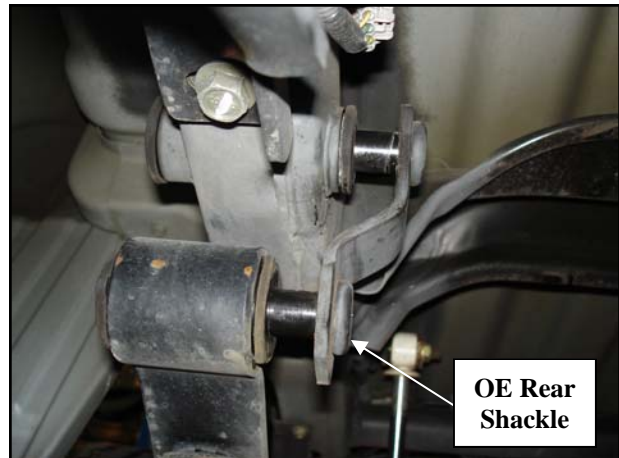

6. Using a floor jack, raise the rear of the vehicle by the bumper until there is adequate room to install the new PRO COMP rear shackle (94-7150).
7. Install the new PRO COMP shackle (94-7150) to the existing holes in the rear frame rail

NOTE: The assembly order of the rear shackle is as follows: 1/2" Bolt > 1/2" washer > bent plate > shackle and straight plate > 1/2" washer > 1/2" nylon locking nut.

IMPORTANT!: The straight shackle

plate mounts on the outside of the frame and the bent shackle plate mounts on the inside of the frame.

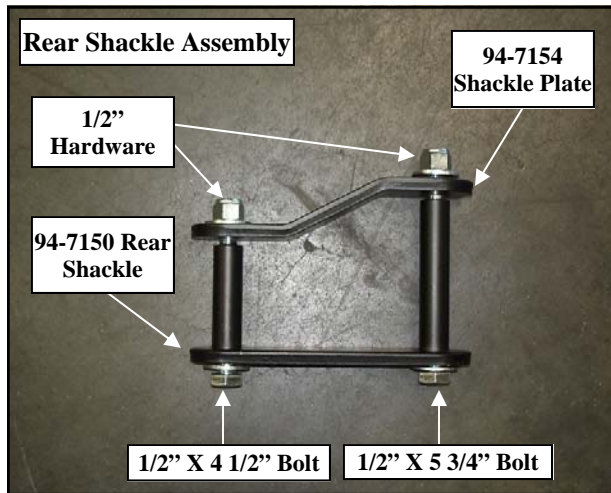

NOTES:

- ⇒ **On completion of the installation, have the suspension and headlights re-aligned.**
- ⇒ **After 100 miles recheck for proper torque on all newly installed hardware.**
- ⇒ **Recheck all hardware for tightness after off road use.**

8. Torque the shackle nuts to 70 ft./lbs.
9. Now would be a good time to inspect the shocks for damage or fluid leakage. Replace if necessary.
NOTE: For improved performance Pro Comp shocks are recommended. See the box on page 2 for applications.
10. Repeat the steps 4 Through 9 on the remaining side of the vehicle.
11. Check all hardware at this time to ensure that everything is tight. Check for adequate clearance on all brake lines and emergency brake cables. Make sure you check with the suspension fully extended, and compressed.
12. Reinstall the spare tire to it's original position.
13. Reinstall the wheels and lower the vehicle to the ground. Torque the lug nuts according to the wheel manufacturers recommendations.
14. Torque all bolts to factory specifications. Re-torque all bolts after 500 miles.

Alignment and Cam Bolt Installation:

Have a certified alignment technician install the PRO COMP cam bolt kit **(90-6410)** when aligning the vehicle.

Alignment Recommendations:

Caster Left: 2.0	Camber Left: 0.5	Toe Left: 1/32"
Caster Right: 2.0	Camber Right: 0.7	Toe Right: 1/32"



Shown with: Pro Comp 16" X 8" wheel (PC 6089) and 265/70 R16 Tires

Use this only as a guide for hardware without a called out torque specification in the instruction manual.

Bolt Torque and ID						
Decimal System			Metric System			
All Torques in Ft. Lbs. Maximums						
Bolt Size	Grade 5	Grade 8	Bolt Size	Class 9.8	Class 10.9	Class 12.9
5/16	15	20	M6	5	9	12
3/8	30	45	M8	18	23	27
7/16	45	60	M10	32	45	50
1/2	65	90	M12	55	75	90
9/16	95	130	M14	85	120	145
5/8	135	175	M16	130	165	210
3/4	185	280	M18	170	240	290

1/2-13x1.75 HHCS **Grade 5 Grade 8**
(No. of Marks + 2)

D T L X

G = Grade (Bolt Strength)
D = Nominal Diameter (Inches)
T = Thread Count (Threads per Inch)
L = Length (Inches)
X = Description (Hex Head Cap Screw)

M12-1.25x50 HHCS

D T L X

P = Property Class (Bolt Strength)
D = Nominal Diameter (Millimeters)
T = Thread Pitch (Thread Width, mm)
L = Length (Millimeters)
X = Description (Hex Head Cap Screw)

Notice to Owner operator, Dealer and Installer:

Vehicles that have been enhanced for off-road performance often have unique handling characteristics due to the higher center of gravity and larger tires. This vehicle may handle, react and stop differently than many passenger cars or unmodified vehicles, both on and off-road. You must drive your vehicle safely! Extreme care should always be taken to prevent vehicle rollover or loss of control, which can result in serious injury or even death. Always avoid sudden sharp turns or abrupt maneuvers and allow more time and distance for braking! Pro Comp reminds you to fasten your seat belts at all times and reduce speed! We will gladly answer any questions concerning the design, function, maintenance and correct use of our products.

Please make sure your Dealer/Installer explains and delivers all warning notices, warranty forms and instruction sheets included with Pro Comp product.

Application listings in this catalog have been carefully fit checked for each model and year denoted. However, Pro Comp reserves the right to update as necessary, without notice, and will not be held responsible for misprints, changes or variations made by vehicle manufacturers. Please call when in question regarding new model year, vehicles not listed by specific body or chassis styles or vehicles not originally distributed in the USA.

Please note that certain mechanical aspects of any suspension lift product may accelerate ordinary wear of original equipment components. Further, installation of certain Pro Comp products may void the vehicle’s factory warranty as it pertains to certain covered parts; it is the consumer’s responsibility to check with their local dealer for warranty coverage before installation of the lift.

Warranty and Return policy:

Pro Comp warrants its full line of products to be free from defects in workmanship and materials. Pro Comp’s obligation under this warranty is limited to repair or replacement, at Pro Comp’s option, of the defective product. Any and all costs of removal, installation, freight or incidental or consequential damages are expressly excluded from this warranty. Pro Comp is not responsible for damages and / or warranty of other vehicle parts related or non-related to the installation of Pro Comp product. A consumer who makes the decision to modify his vehicle with aftermarket components of any kind will assume all risk and responsibility for potential damages incurred as a result of their chosen modifications. Warranty coverage does not include consumer opinions regarding ride comfort, fitment and design. Warranty claims can be made directly with Pro Comp or at any factory authorized Pro Comp dealer.

IMPORTANT! To validate the warranty on this purchase please be sure to mail in the warranty card.

Claims not covered under warranty-

- Parts subject to normal wear, this includes bushings, bump stops, ball joints, tie rod ends and heim joints
 - Discontinued products at Pro Comp’s discretion
- Bent or dented product
- Finish after 90 days
- Leaf or coil springs used without proper bump stops
- Light bulbs
- Products with evident damage caused by abrasion or contact with other items
- Damage caused as a result of not following recommendations or requirements called out in the installation manuals
- Products used in applications other than listed in Pro Comp’s catalog
- Components or accessories used in conjunction with other manufacturer’s systems
- Tire & Wheel Warranty as per Pro Competition Tire Company policy
- Warranty claims without “Proof of Purchase”
- Pro Comp Pro Runner coil over shocks are considered a serviceable shock with a one-year warranty against leakage only. Rebuild service and replacement parts will be available and sold separately by Pro Comp. Contact Pro Comp for specific service charges.
- Pro Comp accepts no responsibility for any altered product, improper installation, lack of or improper maintenance, or improper use of our products.

E-Mail: tech@explorerprocomp.com
Website: www.explorerprocomp.com
Fax: (619) 216-1474
Ph: (619) 216-1444

PLACE
WARRANTY REGISTRATION
NUMBER
HERE: _____