

2360 Boswell Road
Chula Vista, CA 91914
Phone 619.216.1444
Fax 619.216.1474
E-Mail tech@explorerprocomp.com



PRO COMP SUSPENSION

Suspension Systems that Work!

***IMPORTANT:** On V-10 equipped vehicles be sure to check the clearance between the driveshaft and the exhaust. If there is contact take the vehicle to a qualified exhaust shop for modification.*

Part #
52800B/52800BMX
2008-2009
Ford Super Duty
4WD F250-F350
Stage 1 Lift Kit
with Add-A-Leaf

This document contains very important information that includes warranty information and instructions for resolving problems you may encounter. Please keep it in the vehicle as a permanent record.

Box 1 of 4-PN 52800B/52800BMX/52800MXR-1

Part #	Description	Qty.	Illus.	Page
90-3822	SWAY BAR SPACER	1	8	11
90-3823	STEERING STABILIZER BRACKET	1	8	11
90-3812	TRACK BAR DROP BRACKET	1	1,3,9	6,7,11
90-6369	HARDWARE PACK: Track Bar Drop	1	-	-
70-0563001800	9/16" X 3" HEX BOLTS GR. 8	3	3	7
72-05600100816	9/16" STOVER NUTS ZINC	3	3	7
73-05600830	9/16" WASHER SAE GR. 8	6	3	7
90-2357	SWAY BAR END LINK	2	-	-
90-6242	HARDWARE PACK: Sway Bar	2	-	-
600026	3/4" HOURGLASS BUSHING	2	-	-
113600020	SLEEVE	2	-	-
FD-700	PITMAN ARM	1	1	6
95-150F	1 1/2" LIFT BLOCK	2	10	14
95-100F	1" LIFT BLOCK	2	-	-
13-90180	U-BOLT	4	10	14
20-65471	HARDWARE PACK: 5/8" Hi nuts & Washers	1	10	14
90-2511	BUMP STOP SPACER	2	7	10
90-6390	HARDWARE PACK: Bump Stop	1	-	-
70-0436501800	7/16" X 6 1/2" USS GR. 8 HEX BOLT	2	7	10
73-04300034	7/16" SAE FLAT WASHER	4	7	10
72-04300100816	7/16" USS GR.8 STOVER NUT	2	7	10
90-6570	HARDWARE PACK: Sway Bar	1	-	-
90-2413	SWAY BAR END LINK SPACER	2	-	-
90-6042	HARDWARE PACK:Rear Sway Bar Links	2	-	-
45359	5/8" RUBBER HOURGLASS BUSHING	4	-	-
60859H	5/8" O.D. X 12mm I.D. X 1.480" SLEEVE	4	-	-
90-6572	HARDWARE PACK:Rear Sway Bar Links	2	-	-
.120C750HCS1Z	12mm-1.75 X 70mm HEX BOLT GR. 10.9	4	-	-
.120CNNEZ	12mm-1.75 NYLOCK NUT	4	-	-
.120NWHDY	12mm HARDENED FLAT WASHER	8	-	-
90-2446	REAR SWAY BAR END LINKS	2	-	-
96-5002	PITMAN ARM TOOL	1	2	7
90-6595	HARDWARE PACK: Pitman Arm Tool	1	-	-
	Thread locker	1	-	-
0431251800	7/16" X 1 1/4" GR. 8 HEX BOLT	1	2	7
04300030	7/16" FLAT WASHER	1	2	7
04300100512	7/16" NYLOC NUT	2	2	7

Box 2 of 4-PN 52800B/52800BMX/52800MXR-2

Part #	Description	Qty.	Illus.	Page
90-6386	HARDWARE PACK: Radius Arm	1	-	-
90-2507	RADIUS ARM SPACER TUBE	2	4	8
90-3166	RADIUS ARM DROP SIDE PLATE	2	4,5,6	8,9
90-3167	RADIUS ARM DROP SIDE PLATE (With Notch)	2	4,5,6	8,9
90-6370	HARDWARE PACK: Radius Arm Drop	1	-	-
70-0751501800	3/4" X 1 1/2" HEX BOLTS GR. 8	4	4	8
72-075100816	3/4" STOVER NUTS	6	4	8
73-07500830	3/4" WASHERS SAE GR. 8	12	4	8
70-0755001800	3/4" X 5 HEX BOLTS GR. 8	2	4	8
70-0431501800	7/16" X 1 1/2" HEX BOLTS GR.8	8	5	9
72-043100816	7/16" STOVER NUTS	8	5	9
73-04300830	7/16" WASHERS SAE GR. 8	16	5	9
90-6569	HARDWARE PACK: Driveline Shim	1	-	-
90-1080	3/8" Driveline Shim	2	-	-
90-1081	1/4" Driveline Shim	2	-	-
90-1082	1/8" Driveline Shim	2	-	-
90-6013	HARDWARE PACK: Driveline Shim	1	-	-
70-04322501800	7/16" x 2 1/4" USS Grade 8 Bolt	2	-	-
73-04300042	7/16 USS Hardened Washer 2	2	-	-

Box 3 of 4-PN 52800B-3

926553	FRONT SHOCKS	2	-	-
932008	REAR SHOCKS	2	-	-

(OR) Box 3 of 4-PN 52800BMX-3

MX6154	MX6 FRONT SHOCKS	2	-	-
MX6018	MX6 REAR SHOCKS	2	-	-

(OR) Box 3 of 4-PN 52800BMXR-3

MX6065R	MX6R FRONT SHOCKS	2	-	-
MX6069R	MX6R REAR SHOCKS	2	-	-

90-6518	HARDWARE PACK: MX6R Front Shocks	2	-	-
600026	3/4" HOURGLASS URETHANE BUSHING	1	-	-
113600020	SLEEVE	1	-	-

690002	1" SHOCK MOUNT ADAPTER: Front Shocks	2	-	-
--------	---	---	---	---

63012	EXTERNAL RESERVIOR MOUNTING KIT	4	-	-
-------	--	---	---	---

5242	24" LIMIT STRAP	2	-	-
------	------------------------	---	---	---

90-6573	HARDWARE PACK: Limit Straps	1	-	-
70-0503751800	1/2" X 3 1/4" GR. 8 HEX BOLT	2	-	-
72-050100512	1/2" NYLOCK NUT	2	-	-
73-05000034	1/2" SAE FLAT WASHER	6	-	-
72-062100512	5/8" NYLOCK NUT	2	-	-
73-06200034	5/8" USS FLAT WASHER	2	-	-

Box 4 of 4-PN 52800B/52800BMX-4

13150-1	ADD-A-LEAF	2	9	13
13150-2	ADD-A-LEAF	2	9	13

Part #	Description	Qty.	Illus.	Page
90-7130	HARDWARE PACK: Add-A-Leaf	1	-	-
98-00300-1	3" SPRING CLAMP	4	9	13
98-003002	3" SPRING PLATE	4	9	13
97-716	7/16"X 4 1/2" CENTER BOLT	2	9	13
8771-1	7/16"GR. 8 CENTER BOLT NUT	2	9	13
90-6337	HARDWARE PACK: Add-A-Leaf	1	-	-
97-165	10MM X 165MM CENTER PIN	2	9	13
72-01015008812	10MM-1.5 NUT (CENTER BOLT NUT)	2	9	13

Special Tools:

Pitman Puller	Snap-On PN	CJ1119B
Tie Rod Separator	Ford PN	T64P-3590-F
The following parts are used in conjunction with this kit and must be purchased separately.		

24514	COILS GASOLINE ENGINE	1	-	-
<i>OR</i>				
24515	COILS DIESEL ENGINE	1	-	-

Introduction:

- ◆ **This installation requires a professional mechanic!**
- ◆ We recommend that you have access to a factory service manual to assist in the disassembly and reassembly of your vehicle. It contains a wealth of detailed information.
- ◆ Prior to installation, carefully inspect the vehicle's steering and driveline systems paying close attention to the tie rod ends, ball joints, wheel bearing preload, pitman and idler arms. Additionally, check steering-to-frame and suspension-to-frame attaching points for stress cracks. The overall vehicle must be in excellent working condition. Repair or replace all worn or damaged parts!
- ◆ Read the instructions carefully and study the illustrations before attempting installation! You may save yourself a lot of extra work.
- ◆ Check the parts and hardware against the parts list to assure that your kit is complete. Separating parts according to the areas where they will be used and placing the hardware with the brackets before you begin will save installation time.
- ◆ Check the special equipment list and ensure the availability of these tools.
- ◆ Secure and properly block vehicle prior to beginning installation.
- ◆ **ALWAYS** wear safety glasses when using power tools or working under the vehicle!
- ◆ Use caution when cutting is required under the vehicle. The factory undercoating is flammable. Take appropriate precautions. **Have a fire extinguisher close at hand.**
- ◆ Foot pound torque readings are listed on the Torque Specifications chart at the end of the instructions. These are to be used unless specifically directed otherwise. Apply thread lock retaining compound where specified.
- ◆ **Please note that while every effort is made to ensure that the installation of your Pro Comp lift kit is a positive experience, variations in construction and assembly in the vehicle manufacturing process will virtually ensure that some parts may seem difficult to install. Additionally, the current trend in manufacturing of vehicles results in a frame that is highly flexible and may shift slightly on disassembly prior to installation. The use of pry bars and tapered punches for alignment is considered normal and usually does not indicate a faulty product. However, if you are uncertain about some aspect of the installation process, please feel free to call our tech support department at the number listed on the cover page. We do not recommend that you modify the Pro Comp parts in any way as this will void any warranty expressed or implied by the Pro Comp Suspension company.**

Please Note:

- ⇒ Front suspension and head light realignment is necessary!
- ⇒ Speedometer and ABS recalibration will be necessary if larger tires (10% more than stock diameter) are installed.
- ⇒ IT IS ADVISABLE THAT YOU HAVE HELP AVAILABLE WHEN INSTALLING THIS KIT. SOME COMPONENTS ARE HEAVY AND AWKWARD. AN ADDITIONAL SET OF HANDS IS GOOD INSURANCE AGAINST INJURY!

Important!

Due to differences in manufacturing, dimensions and inflated measurements, tire and wheel combinations should be test fit prior to installation. Tire and wheel choice is crucial in assuring proper fit, performance, and the safety of your Pro Comp equipped vehicle. For this application, we recommend a wheel not to exceed 10" in width with a maximum backspacing of 5 3/4" must be used. Additionally, a quality tire of radial design, not exceeding 37" tall X 13.50" wide is also recommended. Violation of these recommendations will not be endorsed as acceptable by Pro Comp Suspension and will void any and all warranties either written or implied.

Before You Begin:

- ⇒ Read the instructions and study the illustrations before attempting the installation.
- ⇒ Separating the parts according to the areas where they will be used and placing the hardware with the brackets before you begin will save installation time.
- ⇒ Check the parts and hardware against the parts list to assure that your kit is complete.
- ⇒ ALWAYS wear safety glasses when using power tools or working beneath your vehicle.
- ⇒ A pitman arm removal tool and tie rod separating tool are required to perform the installation. See the special tools at the top of page 4.
- ⇒ Always use NEW cotter pins on re-assembly! (These items are NOT supplied)

Optional Equipment Available from your Pro Comp Distributor!

**52460B: FRONT DUAL SHOCK KIT,
22518 (x2): LEAF SPRINGS,
95-400SD (x2): 4" LIFT BLOCK,
95-550SD (x2): 5 1/2" LIFT BLOCK,
LIGHTS,
50191: U-BOLT KIT,
599: ALIGNMENT CAM KIT,
72400: TRACTION BARS,
72099: TRACTION BAR MOUNTING KIT
219567: DUAL STEERING STABILIZER
99-400: 4 DEGREE REAR AXLE SHIM KIT**

**Also, check out our outstanding selection of Pro Comp tires
to compliment your new installation!**

Front Installation:

1. Position your vehicle on a smooth, flat, hard surface (i.e. concrete or asphalt). Block the rear tires and set the emergency brake.
2. Measure and record the distance from the center of each wheel to the top of its fender opening. Record below.

LF: _____ RF: _____

LR: _____ RR: _____

3. Place the vehicle in neutral. Place your floor jack under the front axle and raise the vehicle. Place jack stands under the frame rails and lower the frame onto the stands. Remove the jack and place the vehicle back in gear, set the emergency brake, and place blocks both in front and behind the rear wheels.
4. Remove the track bar bolt from the driver side frame mount. Save this hardware for re-use.
5. Remove the cast track bar mount on driver side of frame. Save the bolts and pal nuts. Hardware will be reused.
6. Unbolt the sway bar from the sway bar end links on both sides of the vehicle. Unbolt and remove the sway bar end links from the vehicle. Save the hardware for reuse.
7. Unbolt the sway bar from the frame of the vehicle. Save the hardware for reuse.
8. If the vehicle is equipped with a factory steering stabilizer unbolt it from the frame mounting bracket.
9. Remove the cotter pin and nut from drag link. Save the nut for reinstallation. Use a tie rod separator to separate drag link from Pitman arm.
10. Remove the sector Pitman arm retaining nut and save for reinstallation. Use a Pitman arm puller to remove the OE pitman

arm. The threads of the sector shaft and the Pitman arm retaining nut must be cleaned of all factory dry adhesive.

IMPORTANT!: THE ENTIRE INSTALLATION PROCESS MUST BE DONE WITH HAND TOOLS TO ENSURE PROPER INSTALLATION. DO NOT USE IMPACT TOOLS.

11. Install new pitman arm on sector shaft. Oil the sector shaft threads to ensure a proper torque reading. Install Pitman arm retaining nut and tighten until snug. See **Illustration 1**.
12. Insert the key and unlock the steering wheel.
13. Install the Pitman arm torque tool (**90-5002**) to the Pitman arm using one of the previously removed **OE 14mm** track bar bracket outer retaining bolt and nut plate. See **Illustration 2**.
14. Secure the torque tool (**90-5002**) to the existing hole in the frame crossmember

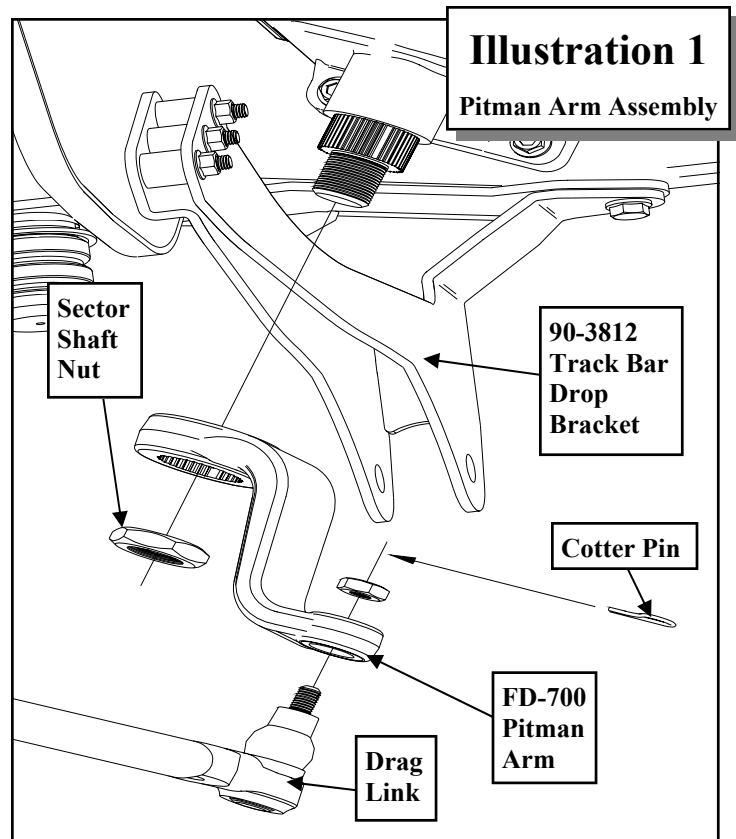

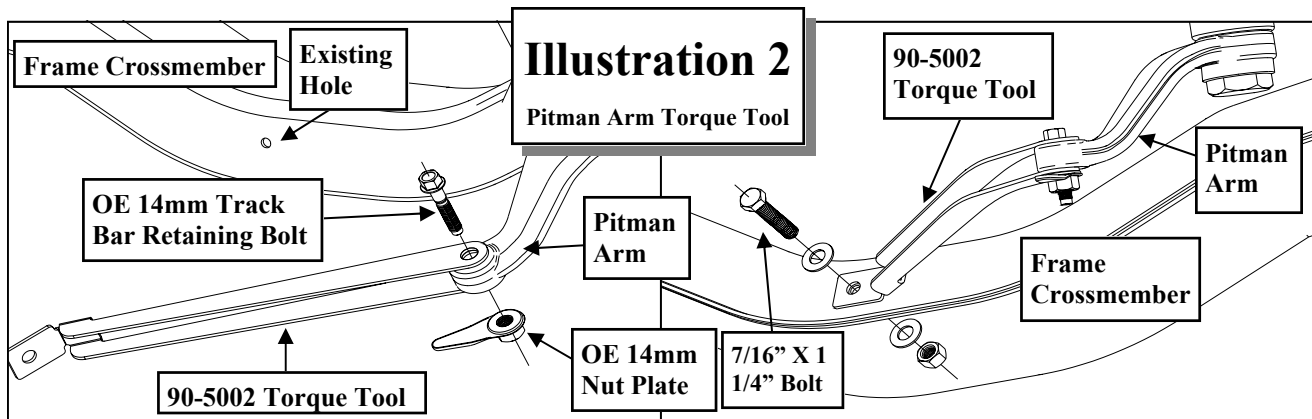

using the supplied 7/16" X 1 1/4" bolt and hardware. See Illustration 2.

NOTE: The steering wheel may need to be turned in order for the hole in the torque tool and the frame crossmember to line up. Once the bolts are tightened the torque tool will align it's self properly.

NOTE: The use of the torque tool is to keep the Pitman arm from moving right or left, but

allow for movement up the sector shaft. If you do not have this tool, a length of chain or a flat bar with two holes is a suitable replacement.

15. Torque the Pitman arm retaining nut to 375 ft./lbs.
16. With the torque tool (90-5002) still in place remove the pitman arm retaining nut. The threads of the sector shaft and the Pitman arm retaining nut **MUST** be cleaned using brake cleaner or another suitable method to remove the previously applied oil.
17. Use the entire supplied thread locking compound to thoroughly cover the entire surface of the threads on the Pitman arm retaining nut.
18. Reinstall the Pitman arm retaining nut to the sector shaft and torque to 350 ft./lbs.
NOTE: Whether re-using the existing pitman arm retaining nut or replacing with a new nut, the supplied locking compound must be used.
19. Unbolt and remove the Pitman arm torque tool (90-5002) from the vehicle.

NOTE: Save this Pitman arm torque tool to add to your toolbox for any future Pitman arm installations.

20. Install track bar drop bracket (90-3812) using (3) 9/16" X 3" and (2) OE bolts. Use thread locker on the bolts. Torque OE the bolts to 129 ft. lbs. and the 9/16"

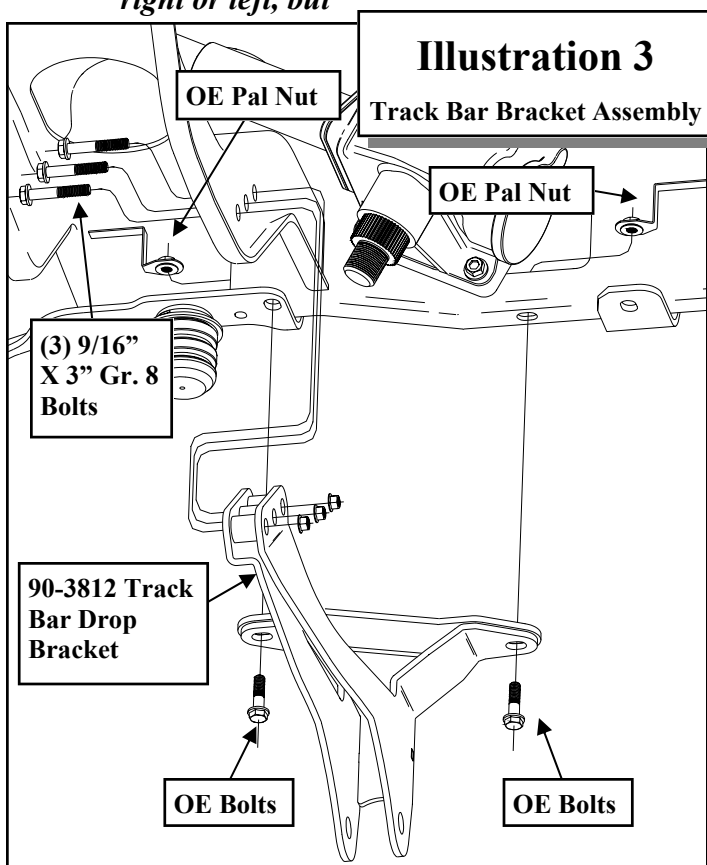

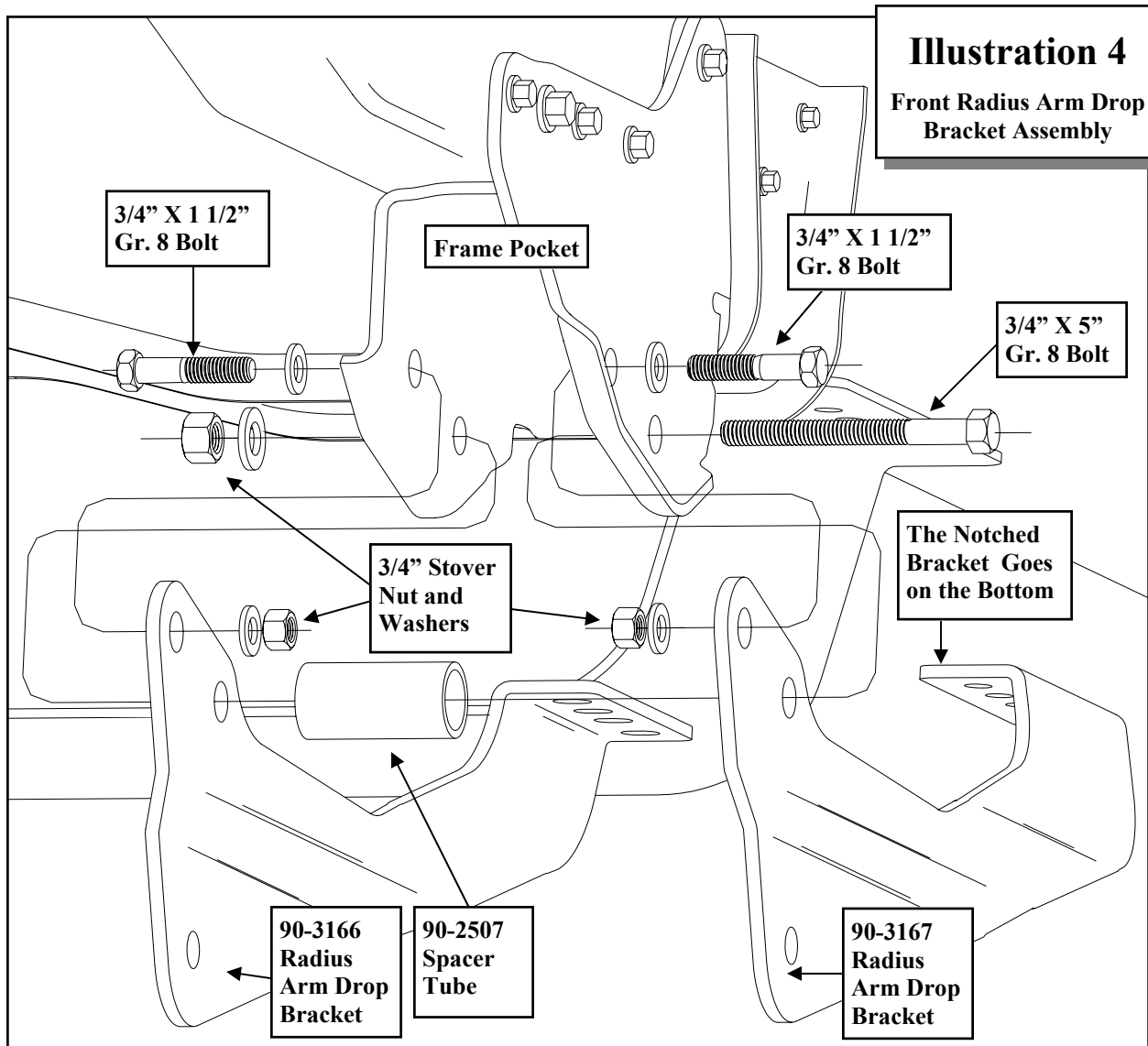

Illustration 4

Front Radius Arm Drop Bracket Assembly

3/4" X 1 1/2"
Gr. 8 Bolt

Frame Pocket

3/4" X 1 1/2"
Gr. 8 Bolt

3/4" X 5"
Gr. 8 Bolt

3/4" Stover
Nut and
Washers

The Notched
Bracket Goes
on the Bottom

90-3166
Radius
Arm Drop
Bracket

90-2507
Spacer
Tube

90-3167
Radius
Arm Drop
Bracket

bolts to 110 ft. lbs. See ILLUSTRATION 3.

21. Unbolt the front brake line bracket from the lower spring perch. Save hardware for reuse.
22. Unbolt and unclip the ABS wiring connected to the radius arm. Save hardware for reuse.
23. On the driver side, unclip the axle vent line from inside the frame.
24. On the passenger side unclip the axle hub vacuum line from inside of the axle bump stop plate.
25. Remove the transfer case skid plate. Also remove the rubber grommets, sleeves and

clips from the frame.

26. Place a jack under the pinion or radius arm. On both sides remove the rear bolts holding the radius arms to the frame of the vehicle.
27. Carefully rotate both radius arms down to provide adequate space to install the new drop brackets.
28. On both sides of the vehicle, assemble the radius arm drop side plates (**90-3166 on top**) and (**90-3167, with the notch in it, on the bottom**) and bolt radius arm drop to the frame. Use the supplied **3/4" X 1 1/2"** bolts in the front hole with the heads of the bolts facing out. Do not torque at

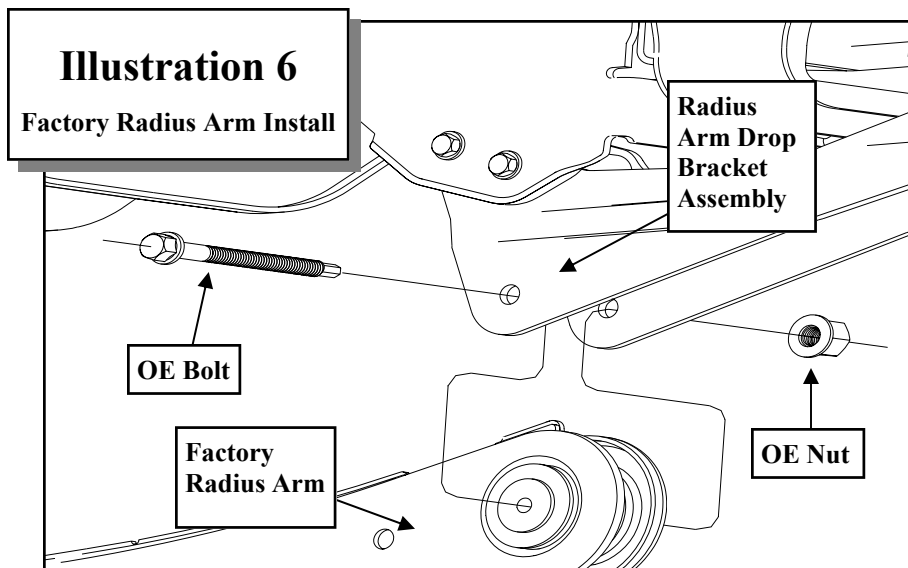
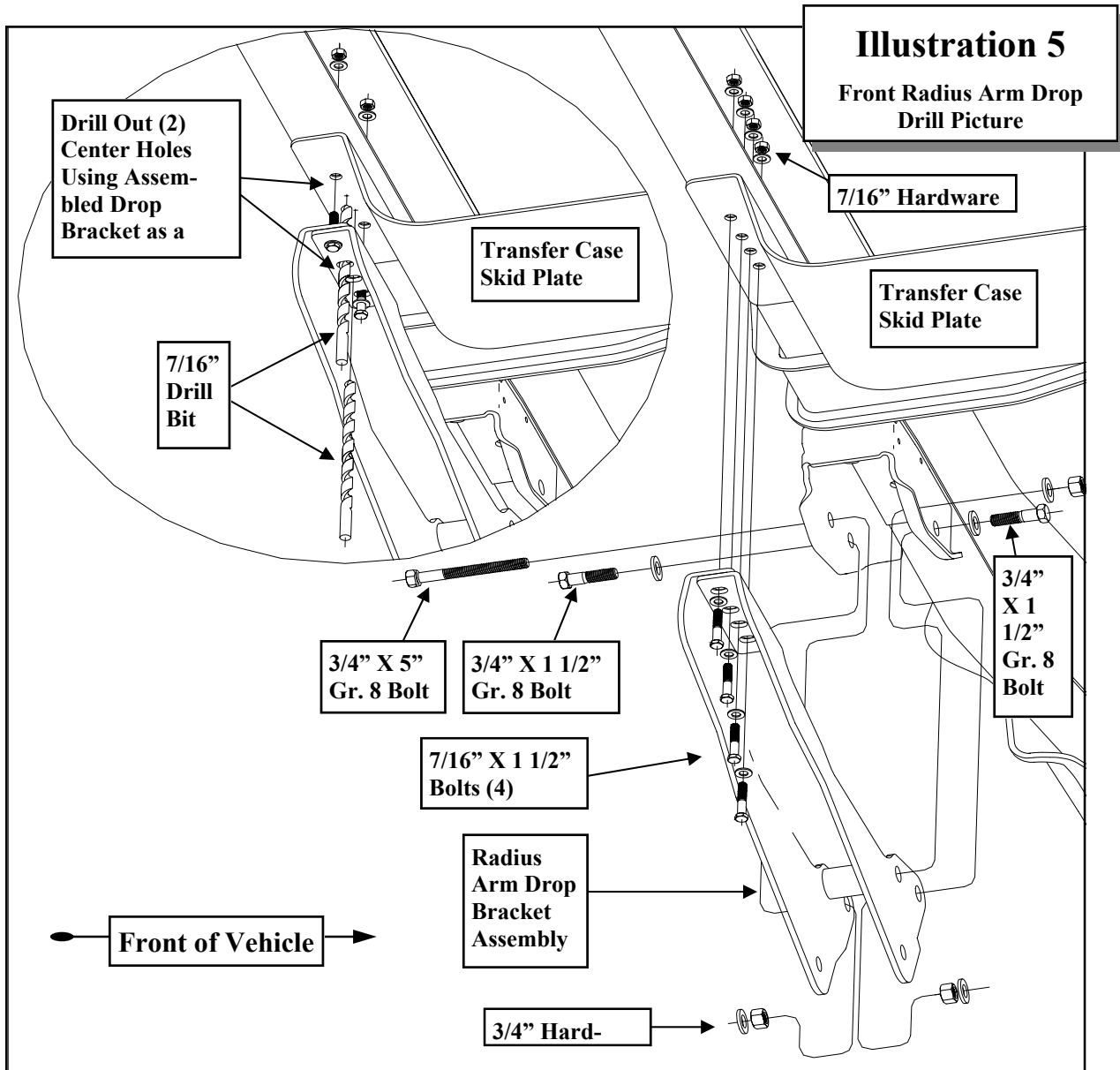

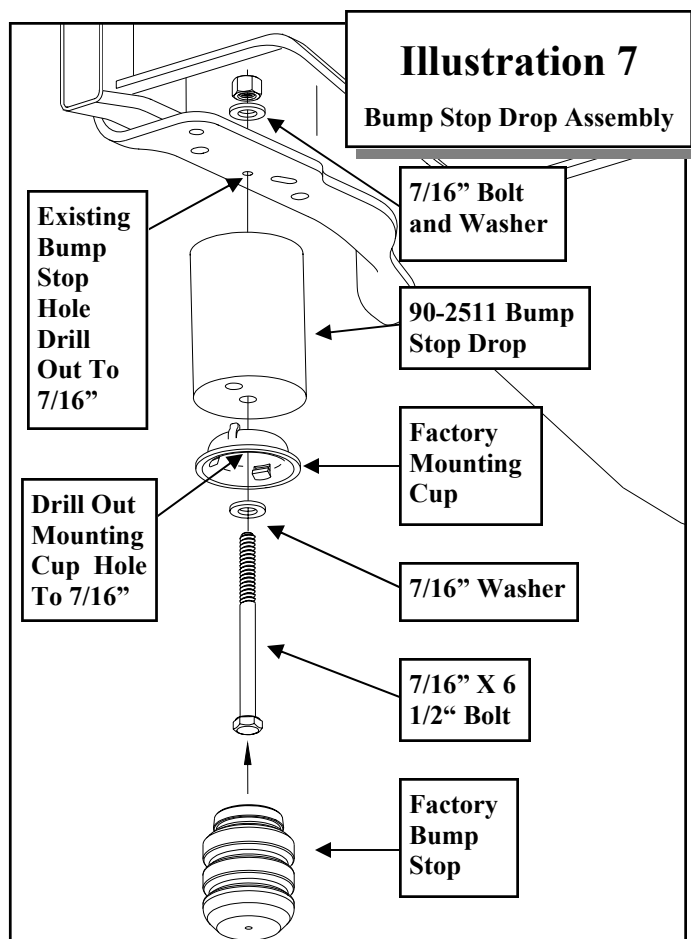

Illustration 7
Bump Stop Drop Assembly

- this time. See ILLUSTRATION 4.
29. Use the spacer tube (90-2507) and the 3/4" X 5" bolt in the rear hole. Do not torque at this time. See ILLUSTRATION 4.
 30. From the rear, slide the previously removed transfer case skid plate in between the frame and the rear of the radius arm drop bracket. Insert (2) 7/16" X 1 1/2" bolts through the outside holes in the rear of the drop bracket and skid plate. Tighten these bolts and use the radius arm bracket holes as a drill template to drill out the (2) inside holes in the factory skid plate and frame. Drill the holes using a 7/16" drill bit. Insert the remaining (2) 7/16" X 1 1/2" bolts in the newly drilled holes. See ILLUSTRATION 5.
 31. Raise the factory radius arm into the lower hole in the drop bracket. Secure

using the OE bolt. Do not tighten this bolt until vehicle is on the ground. See ILLUSTRATION 6.

32. Torque the 7/16" radius arm drop bracket hardware to 60 ft. lbs. and the 3/4" hardware to 200 ft. lbs.
33. Raise the front axle enough to relieve tension on the shock hardware and remove the shocks from the vehicle.
34. Lower the front axle enough to remove the coil springs from the front spring pockets. Save the factory isolators for re-use.

NOTE: Be sure to support the axle while the springs and shocks are removed.

35. Unbolt the front brake line bracket from the frame.
36. Measure approximately 4" down and 1" toward the rear of the vehicle from the original mounting hole for the brake line bracket on the frame rail. Center punch and drill a new 5/16" hole for the new brake line mounting position.

NOTE: The bracket mounting tabs may need to be flattened for reinstallation.

37. Fasten the brake line bracket to the newly drilled hole in the frame using the previously removed OE bolt.

NOTE: Carefully pull down and bend the metal brake line down to create enough slack to accommodate the new lower mounting position. Be sure to tuck the lines back up under the frame.

NOTE: On the driver side make sure that the metal brake line does not come in contact with the steering shaft, rag joint or any moving parts or non-moving parts.

38. Remove the factory front bump stop from the bump stop mounting cup. Pliers and a back and forth rocking motion will assist in removal of the bump stop.

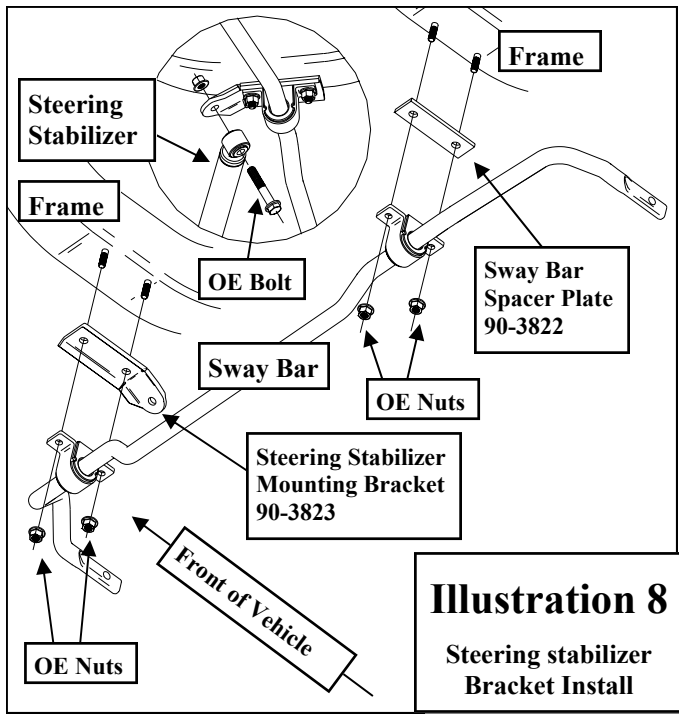

Illustration 8
Steering stabilizer
Bracket Install

39. On the driver side, unbolt the bump stop mounting cup and drill out the factory hole in the frame and bump stop mounting cup to 7/16".
40. On the passenger side, unbolt the bump stop mounting cup. Measure in toward the engine 5/8" from the center of the factory bump stop hole in the frame. Center punch and drill and the new hole 7/16" in the frame. Drill out the bump stop mounting cup to 7/16".
41. Use the supplied 7/16" X 6 1/2" bolt and hardware to bolt the bump stop drop (90-2511) and mounting cup to the bump stop hole in frame. See ILLUSTRATION 7.

NOTE: Be sure to fit the tab from the mounting cup into the hole in the drop.

42. Reinstall the previously removed factory bump stop into the mounting cup on the new bump stop drop. See ILLUSTRATION 7.
43. Using the factory isolators install the supplied front coil springs (24514 Gas or 24515 Diesel) into the spring buckets and raise the axle into place. Make sure the coil spring seats properly on the lower

spring perch.

44. Install the new shocks (926553 or MX6154 or MX6065R). Torque the upper mounting hardware to 46 ft. lbs. and the lower mounting hardware to 111 ft. lbs. Use thread locker on these bolts.

NOTE: If installing the (MX6065R), Press out the existing sleeve and bushing on the shaft end and replace them with bushing (600026) and sleeve (113600020) from hardware pack (90-6518).

NOTE: Use the (2) limit straps (5242) and hardware from pack (90-6573) when installing the MX6R shocks. Secure the limit straps to the upper and lower shock mounting bolts.

45. Install draglink end into pitman arm and torque draglink nut to 148 ft. lbs. Reinstall cotter pin.
46. Raise the sway bar back into place and on the passenger side insert the steering stabilizer bracket (90-3823) under the passenger side sway bar mount. On the driver side insert the sway bar spacer plate (90-3822) under the driver side sway bar mount. Secure using the previously removed OE bolts. See ILLUSTRATION 8.

NOTE: Be sure the steering stabilizer

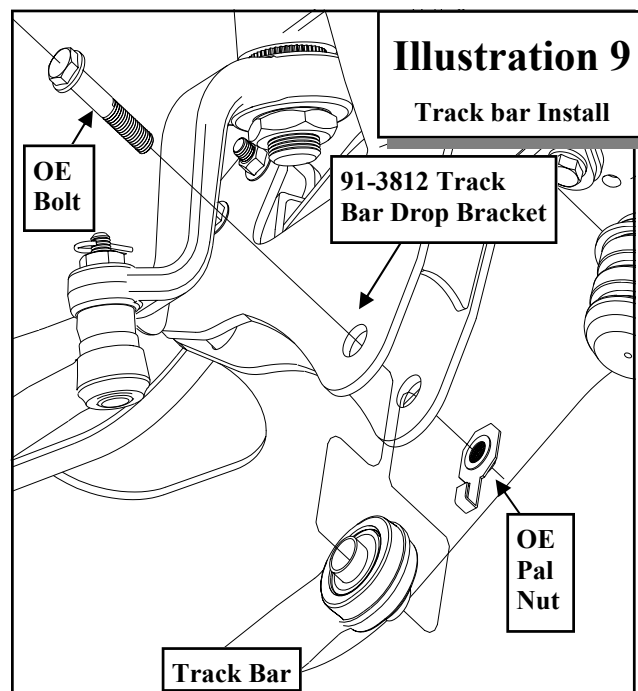

Illustration 9
Track bar Install

mounting hole in the stabilizer bracket is oriented toward the rear of the vehicle.

47. Assemble the front sway bar end links (90-2357) using the supplied bushings (600026) and sleeves (113600020) from hardware pack (90-6242).
48. Bolt the sway bar end links (90-2357) to the original sway bar mounts on the front axle using the sway bar spacer (90-2413) and previously removed OE bolts.
NOTE: Be sure to place the sway bar end link spacer 90-2413 in between the axle mount and the sway bar end link.
49. Attach the sway bar to the new sway bar end links (90-2357) using the previously removed OE bolt.
50. Install the steering stabilizer to the new steering stabilizer bracket (90-3823) using the previously removed OE hardware. See ILLUSTRATION 8.
51. Torque all sway bar and steering stabilizer hardware according to manufacturers specifications.
52. On the driver side, re clip the axle vent line on the frame providing adequate slack for the line at full droop.
53. On the passenger side, reposition the clip on the axle hub vacuum line to provide adequate slack to re-clip the line to the existing hole on the outside of the bump stop plate.
NOTE: Be sure that the newly re-routed vent line does not interfere with the travel of the bump stop.
54. Remove the ABS line from the inner fender. Drill a new hole, using a 15/64" bit, 3" lower in the fender to provide adequate slack for line and reattach the ABS line.
55. Reinstall the ABS wiring onto the radius arms using the factory clips.
56. Refasten the lower brake line mount to

the lower coil spring perch using the OE hardware.

57. Reinstall the front wheels and lower the vehicle to the ground. Torque to manufacturers specs.
58. Torque the OE rear Radius arm bolts to 222 ft. lbs.
59. Reinstall the track bar into the Pro Comp track bar bracket (90-3812) using the OE bolt. Torque to 406 ft. lbs. See ILLUSTRATION 9.

NOTE: You may find that having someone inside the vehicle and moving the steering wheel from side to side will aid in the alignment of the track rod. DO NOT start the engine for this! You only have to move it enough to line the holes up on the track bar mount.

60. On both sides of the vehicle, check the routing of the brake lines and the ABS wire harnesses. There must be no pinching, rubbing, or stretching of either component. At full droop, cycle the steering from lock to lock while observing the reaction of these components. Reposition them if needed.

NOTES:

- ⇒ **On completion of the installation, have the suspension and headlights re-aligned.**
- ⇒ **After 100 miles recheck for proper torque on all newly installed hardware.**
- ⇒ **Recheck all hardware for tightness after off road use.**

Rear Installation:

1. Block the front tires and raise the rear of the vehicle. Support the frame with jack stands forward of the rear springs.
2. Remove the wheels and tires.
3. Remove the shocks on both sides of the vehicle. It may be necessary that you slightly raise the axle to unload the shocks for removal.
4. On the driver side, unbolt the emergency brake line bracket from the upper spring plate. Save hardware for reuse.
5. If your vehicle is equipped with factory sway bar, unbolt it from the end links. Unbolt and remove the end links from the vehicle.
6. Support the rear axle with a floor jack and remove the **U-bolts** on the driver side. Slightly loosen the **U-bolts** on the passenger side.
7. Lower the rear axle and remove the factory block.

NOTE: *Be sure not to over extend the rear brake line and rear axle vent line.*

8. While supporting the rear leaf spring, remove the factory spring mounting bolts and remove the leaf spring from the driver side only at this time.
9. Disassemble leaf spring and insert the add-a-leaves (13150-1 and 13150-2).

NOTE: *The add-a-leaves will be added onto the bottom of the factory spring pack, progressively according to length. Do not install the add-a-leaves below the factory overload spring if the vehicle is equipped with one. See ILLUSTRATION 9.*

10. Using the C-clamps, bolt the leaf pack back together using the supplied center bolt with the head of the bolts facing down and the nut on the top. Reinstall the spring pack to the hangers using the OE hardware. Do not torque at this time.

NOTE: *If installing traction bar kit 72099 install the rear mount at this time.*

APPLICATIONS:

* **FOR VEHICLES EQUIPPED WITH THE FACTORY 4" BLOCK, INSTALL THE ADD-A-LEAVES (13150-1 AND 13150-2), THE 1" ALUMINUM BLOCK (95-100F) AND THE FACTORY BLOCK. SEE ILLUSTRATION 10.**

* **FOR VEHICLES EQUIPPED WITH THE FACTORY 2 1/4" BLOCK, INSTALL THE ADD-A-LEAVES (13150-1 AND 13150-2), 1 1/2" ALUMINUM BLOCK (95-150F) AND THE 1" ALUMINUM BLOCK (95-100F). SEE ILLUSTRATION 10.**

11. Reinstall the factory block and either the 1 1/2" aluminum lift block (95-150F) or 1" aluminum lift block (95-100F) or both depending on application. See the side note for proper applications. Make sure the pin fits into the hole on the spring perch. Use your floor jack to raise the axle to the spring making sure the pin on the factory leaf spring assembly fits into the hole on the lift block. Secure the assembly with the 5/8" U-bolts (13-90180) or (13-90190 from block kit 50191* (*Sold Separately) for vehicles not equipped with a factory overload spring), 5/8" hi-nuts (PN 20-65471) and washers supplied. Do not torque the hi-nuts at this time. See ILLUSTRATION 10.

NOTE: *Make sure the block sits flush on the axle perch.*

12. Repeat the installation on the other side of the vehicle.
13. On driver side, carefully bend down the emergency brake line bracket that secures the line to the frame and bolt the emergency brake line bracket back on to the upper spring plate.
14. Install your new Pro Comp shocks (932008 or MX6018 or MX6069R). Torque the upper mounting hardware to 46 ft. lbs. and the

Illustration 10

Rear Spring With Add-A-Leaf Assembly

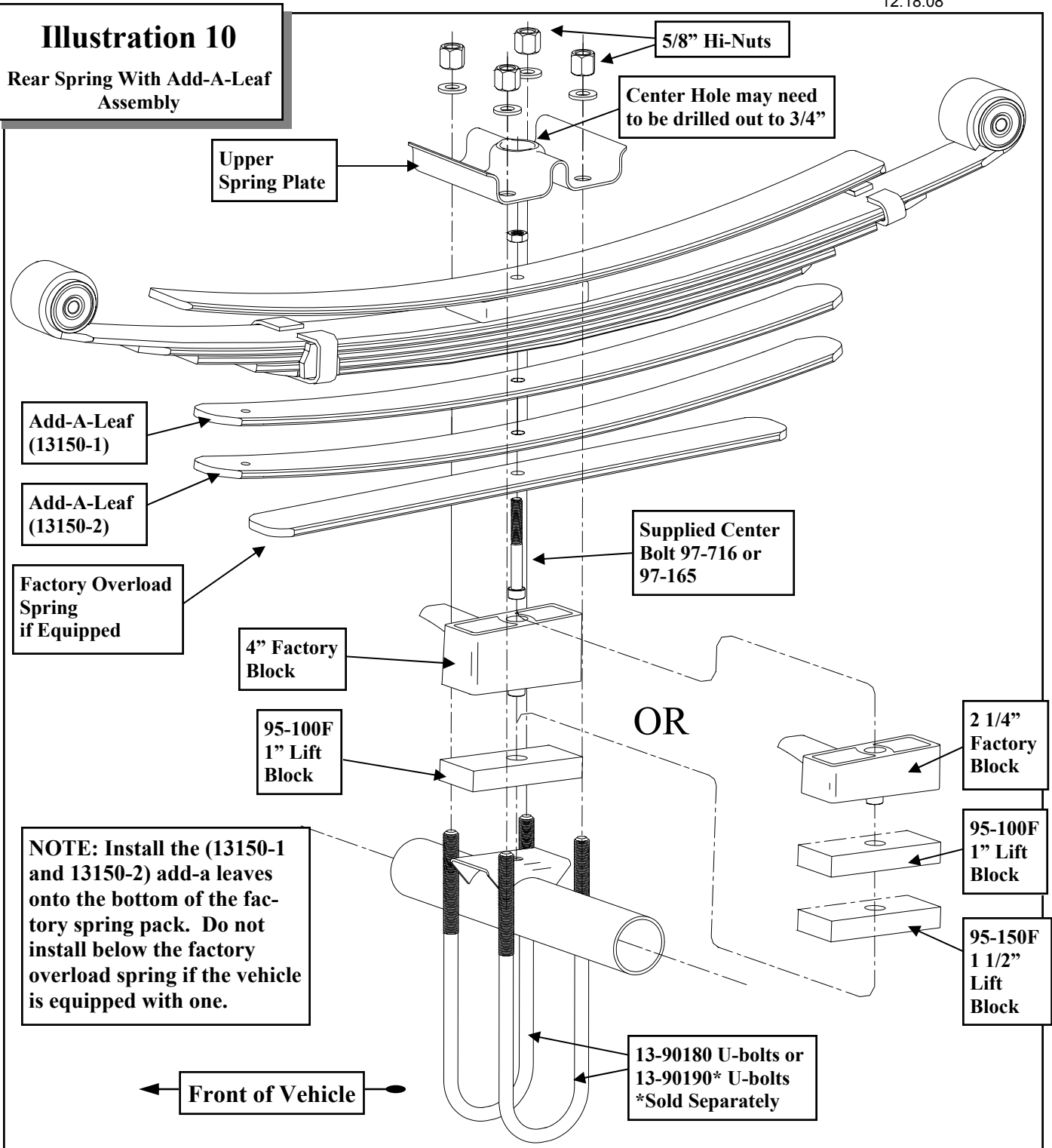

Add-A-Leaf Rear Spacer Options:

1. 4" Factory block plus the add-a-leaves (13150-1 and 13150-2) and 1" lift block (95-100F).
OR
2. 2 1/4" Factory block plus the add-a-leaves (13150-1 and 13150-2), 1 1/2" lift block (95-150F) and 1" lift block (95-100F).

See Inset box after step 10, page 13.

lower mounting hardware to 66 ft. lbs. Use thread locker on these bolts.

- Remove the (2) bolts that secure the center drive shaft bearing. Lower bearing and install 1/4" of shim thickness for each inch of rear lift. Use new 7/16" X 2 1/4" bolts and torque to 55 ft./lbs.

NOTE: 1/4" of shim for each inch of lift is only a starting point. Only by driving the vehicle and adding or removing shims can the high speed vibration be totally eliminated. The off the line vibration is caused by axle wrap up and cannot be eliminated with these products.

- If vehicle came equipped with a rear sway bar, assemble the rear sway bar end links (90-2446) using the bushings (45359) and sleeves (60859H).
- Secure the new rear sway bar end links (90-2446) to the frame and the sway bar using the provided 12mm-1.75 X 70mm. Torque the bolts according to the torque chart on page 15.
- Reinstall the wheels and tires and lower the vehicle to the ground. Torque lug nuts to manufacturer specification.
- Torque the spring mounts at this time. The

front bolts are torqued to 250 ft. lbs. and the rear bolts are torqued to 185 ft. lbs. Torque the 5/8" U-bolts to 120 ft. lbs.

- Re-check the wheel lug torque on all four wheels at this time.
- Re-check all hardware (both the front and the rear) for proper installation and torque!!
- If you wish, you may trim the excess u-bolt thread length. If you do this you should leave approximately one inch of thread exposed after the U-bolts are torqued.
- On both sides of the vehicle, check the routing of the brake lines and the ABS wire harnesses. There must be no pinching, rubbing, or stretching of either component. Reposition them if needed.

NOTES:

- ⇒ On completion of the installation, have the suspension and headlights re-aligned.
- ⇒ After 100 miles recheck for proper torque on all newly installed hardware.
- ⇒ Recheck all hardware for tightness after off road use.

Use this only as a guide for hardware without a called out torque specification in the instruction manual.

Bolt Torque and ID						
Decimal System			Metric System			
All Torques in Ft. Lbs. Maximums						
Bolt Size	Grade 5	Grade 8	Bolt Size	Class 9.8	Class 10.9	Class 12.9
5/16	15	20	M6	5	9	12
3/8	30	45	M8	18	23	27
7/16	45	60	M10	32	45	50
1/2	65	90	M12	55	75	90
9/16	95	130	M14	85	120	145
5/8	135	175	M16	130	185	210
3/4	185	280	M18	170	240	290

<p>1/2-13x1.75 II ICS Grade 5 Grade 0 (No. of Marks + 2)</p>	<p>M12-1.25x50 I ICS</p>
<p>G = Grade (Bolt Strength) D = Nominal Diameter (Inches) T = Thread Count (Threads per Inch) L = Length (Inches) X = Description (Hex Head Cap Screw)</p>	<p>P = Property Class (Bolt Strength) D = Nominal Diameter (Millimeters) T = Thread Pitch (Thread Width, mm) L = Length (Millimeters) X = Description (Hex Head Cap Screw)</p>

Notice to Owner operator, Dealer and Installer:

Vehicles that have been enhanced for off-road performance often have unique handling characteristics due to the higher center of gravity and larger tires. This vehicle may handle, react and stop differently than many passenger cars or unmodified vehicles, both on and off-road. You must drive your vehicle safely! Extreme care should always be taken to prevent vehicle rollover or loss of control, which can result in serious injury or even death. Always avoid sudden sharp turns or abrupt maneuvers and allow more time and distance for braking! Pro Comp reminds you to fasten your seat belts at all times and reduce speed! We will gladly answer any questions concerning the design, function, maintenance and correct use of our products.

Please make sure your Dealer/Installer explains and delivers all warning notices, warranty forms and instruction sheets included with Pro Comp product.

Application listings in this catalog have been carefully fit checked for each model and year denoted. However, Pro Comp reserves the right to update as necessary, without notice, and will not be held responsible for misprints, changes or variations made by vehicle manufacturers. Please call when in question regarding new model year, vehicles not listed by specific body or chassis styles or vehicles not originally distributed in the USA.

Please note that certain mechanical aspects of any suspension lift product may accelerate ordinary wear of original equipment components. Further, installation of certain Pro Comp products may void the vehicle's factory warranty as it pertains to certain covered parts; it is the consumer's responsibility to check with their local dealer for warranty coverage before installation of the lift.

Warranty and Return policy:

Pro Comp warrants its full line of products to be free from defects in workmanship and materials. Pro Comp's obligation under this warranty is limited to repair or replacement, at Pro Comp's option, of the defective product. Any and all costs of removal, installation, freight or incidental or consequential damages are expressly excluded from this warranty. Pro Comp is not responsible for damages and / or warranty of other vehicle parts related or non-related to the installation of Pro Comp product. A consumer who makes the decision to modify his vehicle with aftermarket components of any kind will assume all risk and responsibility for potential damages incurred as a result of their chosen modifications. Warranty coverage does not include consumer opinions regarding ride comfort, fitment and design. Warranty claims can be made directly with Pro Comp or at any factory authorized Pro Comp dealer.

IMPORTANT! To validate the warranty on this purchase please be sure to mail in the warranty card.

Claims not covered under warranty-

- Parts subject to normal wear, this includes bushings, bump stops, ball joints, tie rod ends and heim joints
 - Discontinued products at Pro Comp's discretion
- Bent or dented product
- Finish after 90 days
- Leaf or coil springs used without proper bump stops
- Light bulbs
- Products with evident damage caused by abrasion or contact with other items
- Damage caused as a result of not following recommendations or requirements called out in the installation manuals
- Products used in applications other than listed in Pro Comp's catalog
- Components or accessories used in conjunction with other manufacturer's systems
- Tire & Wheel Warranty as per Pro Competition Tire Company policy
- Warranty claims without "Proof of Purchase"
- Pro Comp Pro Runner coil over shocks are considered a serviceable shock with a one-year warranty against leakage only. Rebuild service and replacement parts will be available and sold separately by Pro Comp. Contact Pro Comp for specific service charges.
- Pro Comp accepts no responsibility for any altered product, improper installation, lack of or improper maintenance, or improper use of our products.

E-Mail: tech@explorerprocomp.com
Website: www.explorerprocomp.com
Fax: (619) 216-1474
Ph: (619) 216-1444

PLACE
WARRANTY REGISTRATION
NUMBER
HERE: _____