

2360 Boswell Road
Chula Vista, CA 91914
Phone 619.216.1444
Fax 619.216.1474
E-Mail tech@explorerprocomp.com



PRO COMP SUSPENSION

Suspension Systems that Work!

**Part #
52515B/52515BMX
2005-2006
Ford Super Duty
4WD F250-350
Stage 2 Lift Kit
with Leaf Springs**

This document contains very important information that includes warranty information and instructions for resolving problems you may encounter. Please keep it in the vehicle as a permanent record.

Box 1 of 3-PN 52515B/52515BMX-1

Part #	Description	Qty.	Illus.	Page
90-6369	HARDWARE PACK: Track Bar Drop	1	-	-
70-0563001800	9/16" X 3" HEX BOLTS GR. 8	3	1	6
72-05600100816	9/16" STOVER NUTS ZINC	3	1	6
73-05600830	9/16" WASHER SAE GR. 8	6	1	6
90-6315	HARDWARE PACK: Sway Bar Drop Top	2	-	-
70-0431751800	7/16" X 1 3/4" GR. 8 HEX BOLT	4	6a,6b	10
73-04300034	7/16" HARDENED FLAT WASHER	8	6a,6b	10
72-04300100816	7/16" GR. 8 STOVER NUT	4	6a,6b	10
90-6337	HARDWARE PACK: Leaf Springs	1	-	-
97-165	10MM X 165MM CENTER PIN	2	9	14
72-01015008812	10MM-1.5 NUT (CENTER BOLT)	2	9	14
90-6340	HARDWARE PACK: Sway Bar Drop Bottom	2	-	-
70-0431251800	7/16" X 1 1/4" GR. 8 HEX BOLT- (2 not used)	4	6a,6b	10
73-04300034	7/16" HARDENED FLAT WASHER- (4 not used)	8	6a,6b	10
72-04300100816	7/16" GR. 8 STOVER NUT- (2 not used)	4	6a,6b	10
90-6379	HARDWARE PACK: Brake line	1	-	-
70-0251751500	1/4" X 1 3/4" Gr. 5 BOLT	2	-	-
73-02500530	1/4" FLAT WASHER	4	-	-
72-025100512	1/4" NYLOCK NUT	2	-	-
90-6387	HARDWARE PACK: Brake line	1	-	-
90-2159	BRAKE LINE SPACER TUBE	2	-	-
90-2055	SWAY BAR DROP SPACER	4	6a	10
90-6390	HARDWARE PACK: Bump Stop	1	-	-
70-0435501800	7/16" X 6 1/2" USS GR. 8 HEX BOLT	2	7	11
73-04300034	7/16" SAE FLAT WASHER	4	7	11
72-04300100816	7/16" USS GR.8 STOVER NUT	2	7	11
20-65471	HARDWARE PACK: 5/8" High nuts & Washers	1	9	14
90-1859	SWAY BAR DROP BRACKET	2	6a,6b	10
13-90190	U-BOLT	4	9	14
90-3198	STEERING STABILIZER BRACKET	1	6a,6b	10
90-2506	RADIUS ARM—Passenger Side	1	-	-
90-2509	SWAY BAR DROP SUPPORT TUBE	1	6a,6b	10
90-6399	HARDWARE PACK: Radius Arms	1	4	8
.180CNUCZ	18MM-2.5 STOVER NUT	1	4	8
.180NWHZ	18MM HARDENED FLAT WASHER	1	4	8

Box 2 of 3-PN 52515B/52515BMX-2

Part #	Description	Qty.	Illus.	Page
90-5093	TRACK BAR DROP BRACKET	1	1,2,8	6,7,11
90-2502	RADIUS ARM-Driver Side	1	4,5	8
90-2511	BUMP STOP SPACER	2	7	11
FD-700	PITMAN ARM	1	2	7
95-100F	1" LIFT BLOCK	2	3	14
96-5002	PITMAN ARM TOOL	1	2	7
90-6595	HARDWARE PACK: Pitman Arm Tool	1	-	-
	Thread locker	1	-	-
0431251800	7/16" X 1 1/4" GR. 8 HEX BOLT	1	2	7
04300030	7/16" FLAT WASHER	1	2	7
04300100512	7/16" NYLOC NUT	2	2	7

Box 3 of 3-PN 52515B-3

926553	FRONT SHOCKS	2	-	-
932008	REAR SHOCKS	2	-	-

(OR) Box 3 of 3-PN 52515BMX-3

MX6122	MX6 FRONT SHOCKS	2	-	-
MX6018	MX6 REAR SHOCKS	2	-	-

Special Tools:

Pitman Puller	Snap-On PN	CJ1119B
Tie Rod Separator	Ford PN	T64P-3590-F

The following parts are used in conjunction with this kit and must be purchased separately.

24514	COILS GASOLINE ENGINE	1	-	-
24515	OR COILS DIESEL ENGINE	1	-	-

Introduction:

- ◆ **This installation requires a professional mechanic!**
- ◆ We recommend that you have access to a factory service manual to assist in the disassembly and reassembly of your vehicle. It contains a wealth of detailed information.
- ◆ Prior to installation, carefully inspect the vehicle's steering and driveline systems paying close attention to the tie rod ends, ball joints, wheel bearing preload, pitman and idler arms. Additionally, check steering-to-frame and suspension-to-frame attaching points for stress cracks. The overall vehicle must be in excellent working condition. Repair or replace all worn or damaged parts!
- ◆ Read the instructions carefully and study the illustrations before attempting installation! You may save yourself a lot of extra work.
- ◆ Check the parts and hardware against the parts list to assure that your kit is complete. Separating parts according to the areas where they will be used and placing the hardware with the brackets before you begin will save installation time.
- ◆ Check the special equipment list and ensure the availability of these tools.
- ◆ Secure and properly block vehicle prior to beginning installation.
- ◆ ***ALWAYS*** wear safety glasses when using power tools or working under the vehicle!
- ◆ Use caution when cutting is required under the vehicle. The factory undercoating is flammable. Take appropriate precautions. **Have a fire extinguisher close at hand.**
- ◆ Foot pound torque readings are listed on the Torque Specifications chart at the end of the instructions. These are to be used unless specifically directed otherwise. Apply thread lock retaining compound where specified.
- ◆ *Please note that while every effort is made to ensure that the installation of your Pro Comp lift kit is a positive experience, variations in construction and assembly in the vehicle manufacturing process will virtually ensure that some parts may seem difficult to install. Additionally, the current trend in manufacturing of vehicles results in a frame that is highly flexible and may shift slightly on disassembly prior to installation. The use of pry bars and tapered punches for alignment is considered normal and usually does not indicate a faulty product. However, if you are uncertain about some aspect of the installation process, please feel free to call our tech support department at the number listed on the cover page. We do not recommend that you modify the Pro Comp parts in any way as this will void any warranty expressed or implied by the Pro Comp Suspension company.*

Please Note:

- ⇒ Front suspension and head light realignment is necessary!
- ⇒ Speedometer and ABS recalibration will be necessary if larger tires (10% more than stock diameter) are installed.
- ⇒ **IT IS ADVISABLE THAT YOU HAVE HELP AVAILABLE WHEN INSTALLING THIS KIT. SOME COMPONENTS ARE HEAVY AND AWKWARD. AN ADDITIONAL SET OF HANDS IS GOOD INSURANCE AGAINST INJURY!**

Important!

Due to differences in manufacturing, dimensions and inflated measurements, tire and wheel combinations should be test fit prior to installation. Tire and wheel choice is crucial in assuring proper fit, performance, and the safety of your Pro Comp equipped vehicle. For this application, we recommend a wheel not to exceed 9" in width with a maximum backspacing of 5 3/4" must be used. Additionally, a quality tire of radial design, not exceeding 35" tall X 12.5" or 13.50" wide is also recommended. Violation of these recommendations will not be endorsed as acceptable by Pro Comp Suspension and will void any and all warranties either written or implied.

Before You Begin:

- ⇒ Read the instructions and study the illustrations before attempting the installation.
- ⇒ Separating the parts according to the areas where they will be used and placing the hardware with the brackets before you begin will save installation time.
- ⇒ Check the parts and hardware against the parts list to assure that your kit is complete.
- ⇒ ALWAYS wear safety glasses when using power tools or working beneath your vehicle.
- ⇒ A pitman arm removal tool and tie rod separating tool are required to perform the installation. See the special tools at the bottom of page 3.
- ⇒ Always use NEW cotter pins on re-assembly! (These items are NOT supplied)

Optional Equipment Available from your Pro Comp Distributor!

**22415 REAR LEAF SPRINGS,
LIGHTS,
52480 CARRIER BEARING SHIM KIT,
599 ALIGNMENT CAM KIT,
50191 U-Bolt Kit,
72400: TRACTION BARS,
72099: TRACTION BAR MOUNTING KIT
219567: DUAL STEERING STABILIZER
99-400: 4 DEGREE REAR AXLE SHIM KIT**
Also, check out our outstanding selection of Pro Comp tires
to compliment your new installation!

Front Installation:

1. Position your vehicle on a smooth, flat, hard surface (i.e. concrete or asphalt). Block the rear tires and set the emergency brake.
2. Measure and record the distance from the center of each wheel to the top of its fender opening. Record below.

LF: _____ RF: _____

LR: _____ RR: _____

3. Place the vehicle in neutral. Place your floor jack under the front axle and raise the vehicle. Place jack stands under the frame rails and lower the frame onto the stands. Remove the jack and place the vehicle back in gear, set the emergency brake, and place blocks both in front and behind the rear wheels.
4. Remove the track bar bolt from the driver side frame mount. Save this hardware for re-use.
5. Remove cast track bar mount on driver side of frame. Save the bolts and pal nuts. Hardware will be reused.
6. Unbolt the sway bar from the sway bar end links on both sides of the vehicle. Rotate forward out of the work area.
7. If the vehicle is equipped with a factory steering stabilizer unbolt it from the frame mounting bracket and remove the factory bracket from the frame.
8. Remove the cotter pin and nut from drag link. Save the nut for reinstallation. Use a tie rod separator to separate drag link from Pitman arm.
9. Remove the sector Pitman arm retaining nut and save for reinstallation. Use a Pitman arm puller to remove the OE pitman arm. The threads of the sector shaft and the Pitman arm retaining nut must be cleaned of

all factory dry adhesive.

IMPORTANT!: THE ENTIRE INSTALLATION PROCESS MUST BE DONE WITH HAND TOOLS TO ENSURE PROPER INSTALLATION. DO NOT USE IMPACT TOOLS.

10. Install new pitman arm on sector shaft. Oil the sector shaft threads to ensure a proper torque reading. Install Pitman arm retaining nut and tighten until snug. See **Illustration 1**.
11. Insert the key and unlock the steering wheel.
12. Install the Pitman arm torque tool (90-5002) to the Pitman arm using one of the previously removed OE 14mm track bar bracket outer retaining bolt and nut plate. See **Illustration 2**.
13. Secure the torque tool (90-5002) to the existing hole in the frame crossmember using the supplied 7/16" X 1 1/4" bolt and hardware. See **Illustration 2**.

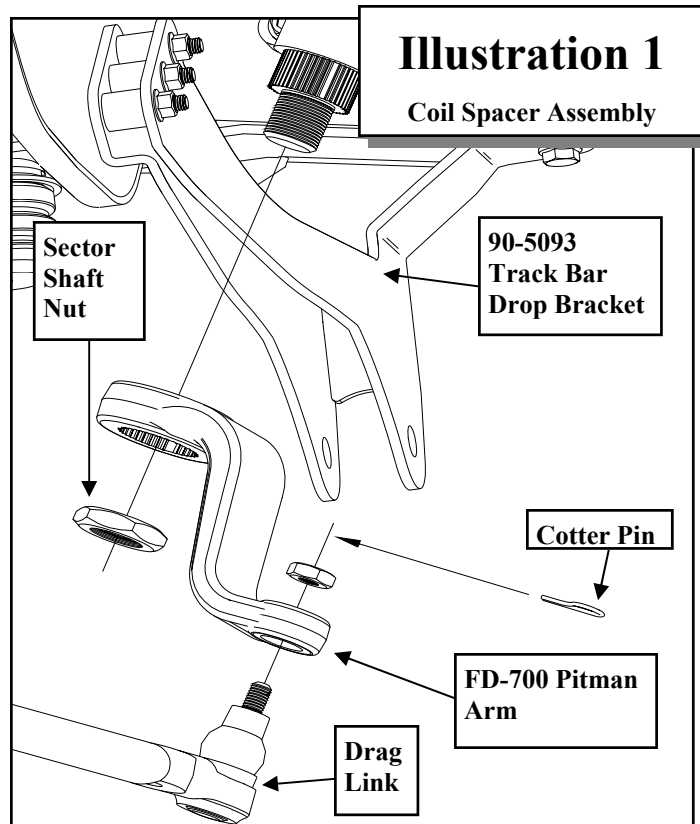

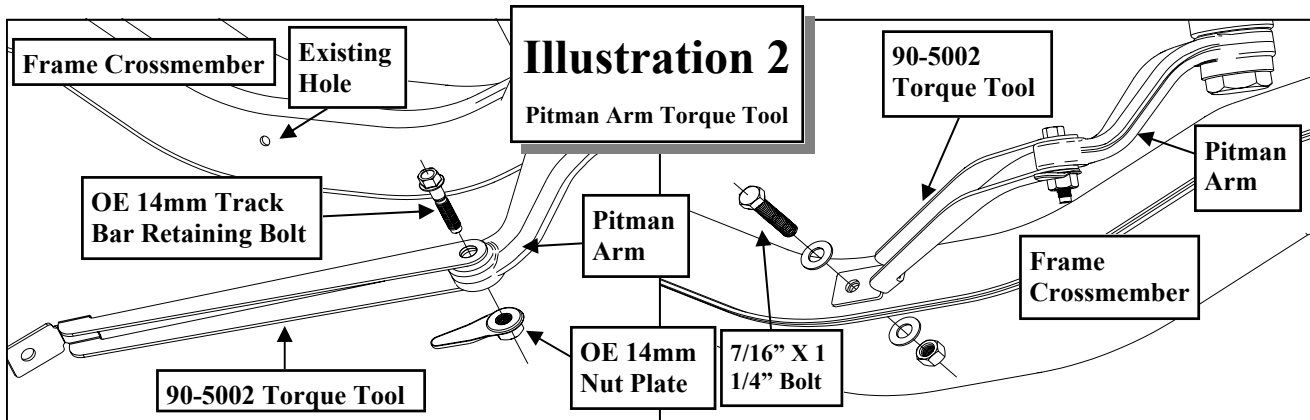

NOTE: The steering wheel may need to be turned in order for the hole in the torque tool and the frame crossmember to line up. Once the bolts are tightened the torque tool will align it's self properly.

NOTE: The use of the torque tool is to keep the Pitman arm from moving right or left, but allow for movement up the sector shaft. If you do not have this tool, a length of chain or a flat bar with two holes is a suitable replacement.

- Torque the Pitman arm retaining nut to 375 ft./lbs.

- With the torque tool (90-5002) still in place remove the pitman arm retaining nut. The threads of the sector shaft and the Pitman arm retaining nut **MUST** be cleaned using brake cleaner or another suitable method to remove the previously applied oil.
- Use the entire supplied thread locking compound to thoroughly cover the entire surface of the threads on the Pitman arm retaining nut.
- Reinstall the Pitman arm retaining nut to the sector shaft and torque to 350 ft./lbs.

NOTE: Whether re-using the existing pitman arm retaining nut or replacing with a new nut, the supplied locking compound must be used.

- Unbolt and remove the Pitman arm torque tool (90-5002) from the vehicle.

NOTE: Save this Pitman arm torque tool to add to your toolbox for any future Pitman arm installations.

- Install track bar drop bracket (90-5093) using (3) 9/16" X 3" and (2) OE bolts. Use thread locker on the bolts. Torque OE the bolts to 129 ft. lbs. and the 9/16" bolts to 110 ft. lbs. See ILLUSTRATION 3.
- Unbolt the front brake line bracket from the lower spring perch. Save hardware for reuse.
- Unbolt and unclip the ABS wiring connected to the radius arm. Save hardware for reuse.
- On the driver side, unclip the axle vent line

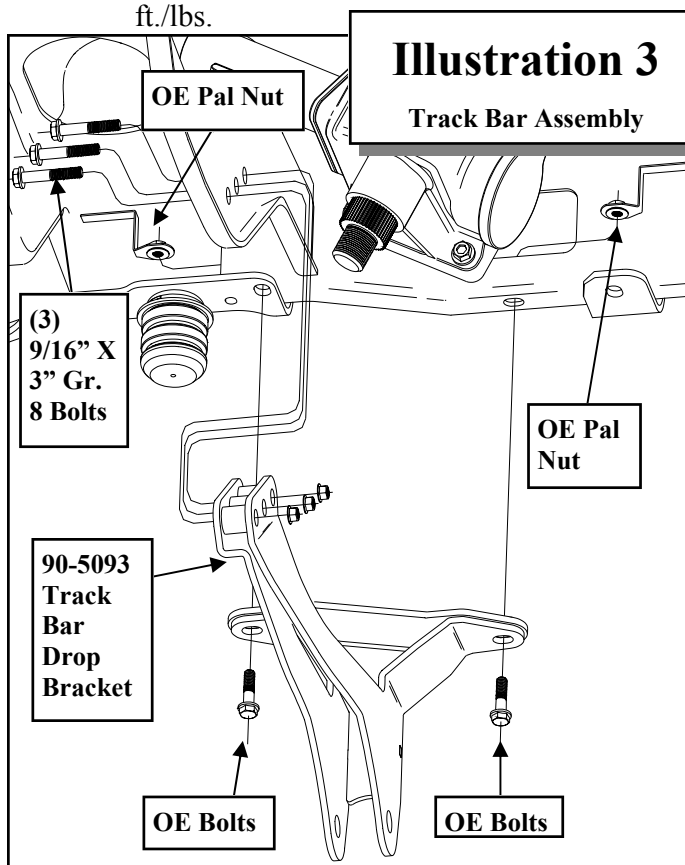

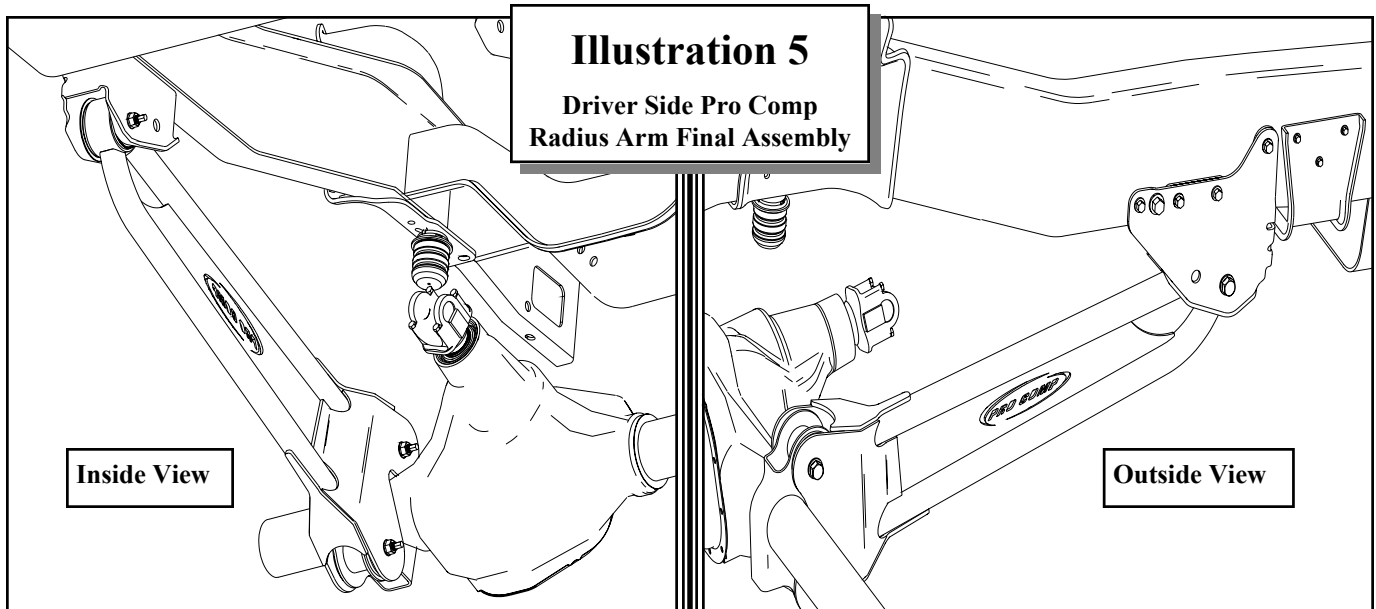
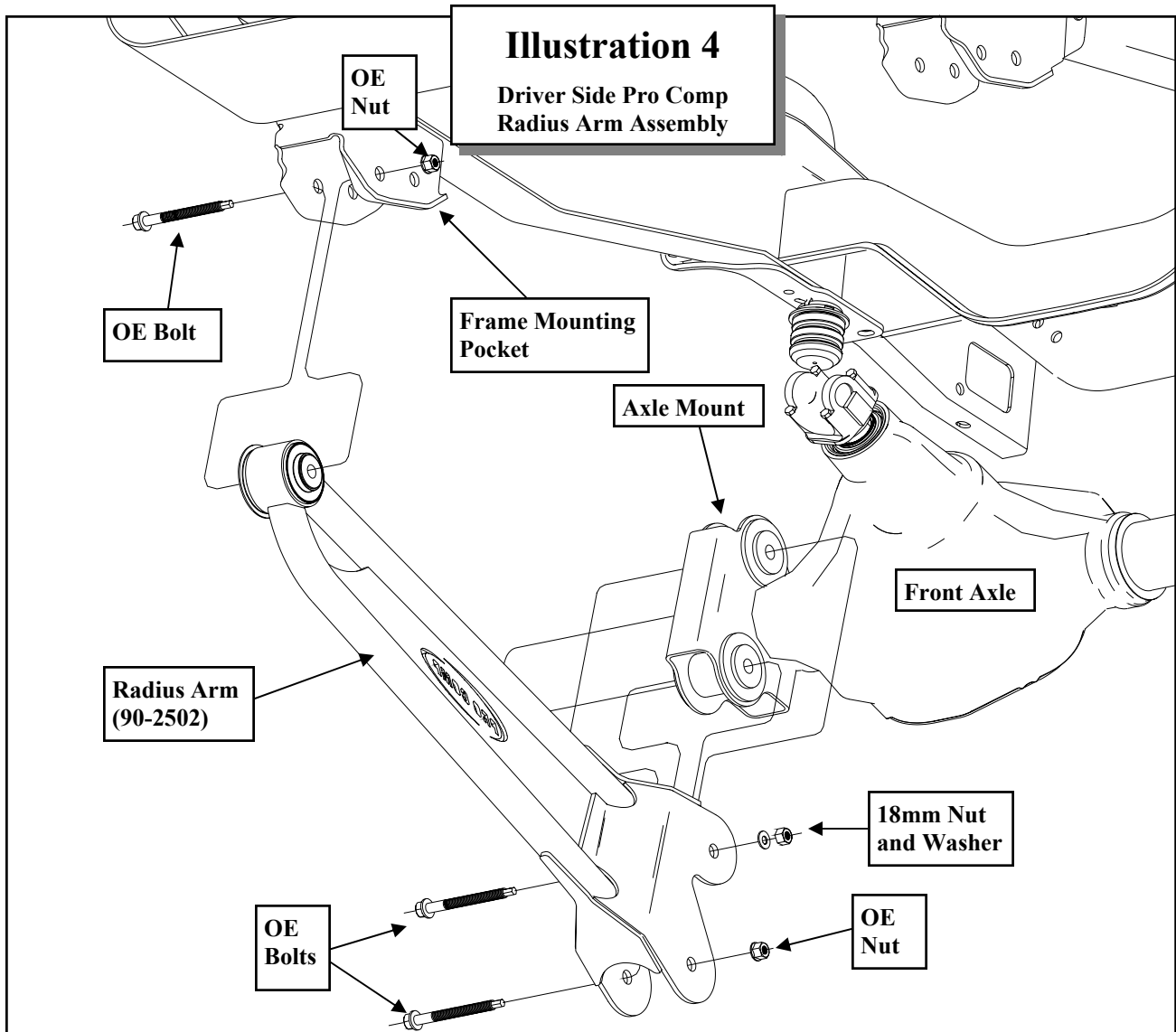

from inside the frame.

23. On the passenger side unclip the axle hub vacuum line from inside of the axle bump stop plate.
24. Raise the front axle enough to relieve tension on the shock hardware and remove the shocks from the vehicle.
25. Lower the front axle enough to remove the coil springs from the front spring bucket. Save the factory isolators for re-use.
26. Support the front axle with jack stands and place a floor jack under the rear of the differential housing.
27. Unbolt and remove the passenger side radius arm from the vehicle by taking out the (3) OE mounting bolts from the front axle and the rear frame mounting pocket.

NOTE: If installing a Pro Comp double shock hoop kit, drill holes and install the passenger side (90-3271) upper sway bar drop bracket to frame at this time.

28. On the driver side remove the rear radius arm to frame mounting bolt.
29. Using the floor jack carefully pivot the rear of the differential housing down. This will allow for easier installation of the new passenger side radius arm.
30. On the passenger side, install the new Pro Comp radius arm (90-2506) using the (3) previously removed OE bolts. Leave bolts loose. See ILLUSTRATION 4.
31. Remove the driver side radius arm from the vehicle.

NOTE: If installing a Pro Comp double shock hoop kit, drill holes and install the driver side (90-3270) upper sway bar drop bracket to frame at this time.

32. Install the driver side Pro Comp radius arm (90-2502) using the (3) previously removed OE bolts, (2) OE nuts and the supplied (1) 18mm nut and (1) hardened washer.

NOTE: Use thread locker on the OE bolts, nuts and new 18mm nut.

33. Torque the front axle mount bolts to 222 ft. lbs. Do not torque the rear mounting bolt until vehicle is on the ground. See ILLUSTRATION 4.
34. Unbolt the front brake line bracket from the upper spring bucket.
35. Measure approximately 6" down from the mounting hole for the brake line bracket on the spring bucket. Center punch and drill a new 17/64" hole for the new brake line mounting position.
36. Using the brake line spacer (90-2159) and supplied 1/4" X 1 3/4" bolt to secure the factory brake line to the newly drilled hole in the spring bucket. Carefully bend the bracket away from the frame to keep the lines and bracket from rubbing.

NOTE: Carefully pull down and bend the metal brake line down to create enough slack to accommodate the new lower mounting position. Be sure to tuck the lines back up under the frame.

NOTE: On the driver side make sure that the metal brake line does not come in contact with the steering shaft, rag joint or any moving parts or non-moving parts.

37. Remove the sway bar and factory clips from the frame on both sides of the vehicle. Note orientation of the sway bar for reinstallation.
38. Install sway bar drop brackets (90-1859). Assemble all components shown before you begin to tighten any hardware. Use the (4) 7/16" X 1 3/4" bolts, hardware and spacers (4) (90-2055) to secure the drop brackets to the frame. See ILLUSTRATION 6a.
39. On the driver side, bolt the sway bar support tube (90-2509), above the lower radiator hose and cooler lines, to the drop bracket with (2) 7/16" X 1 1/4" and hardware. See ILLUSTRATION 6b.
40. On the passenger side, bolt the sway bar support tube (90-2509) and steering stabilizer bracket (90-3198) to the sway bar drop bracket using the (3) 7/16" X 1 1/4" and

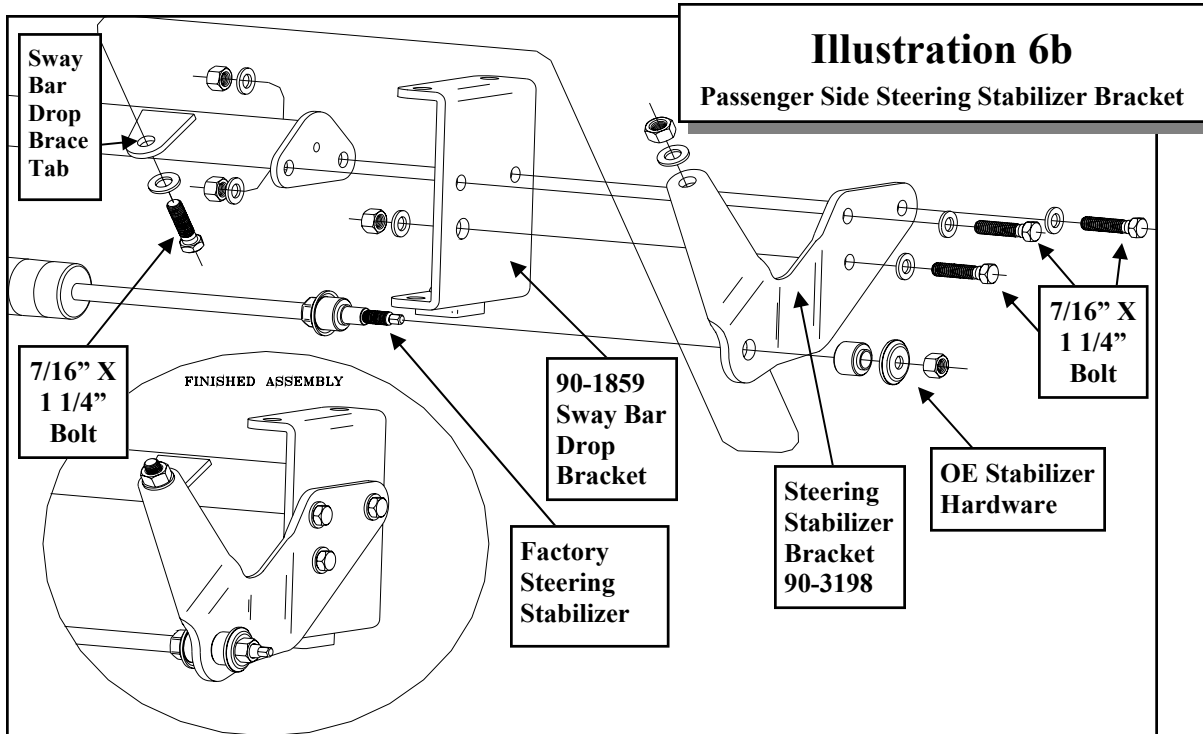
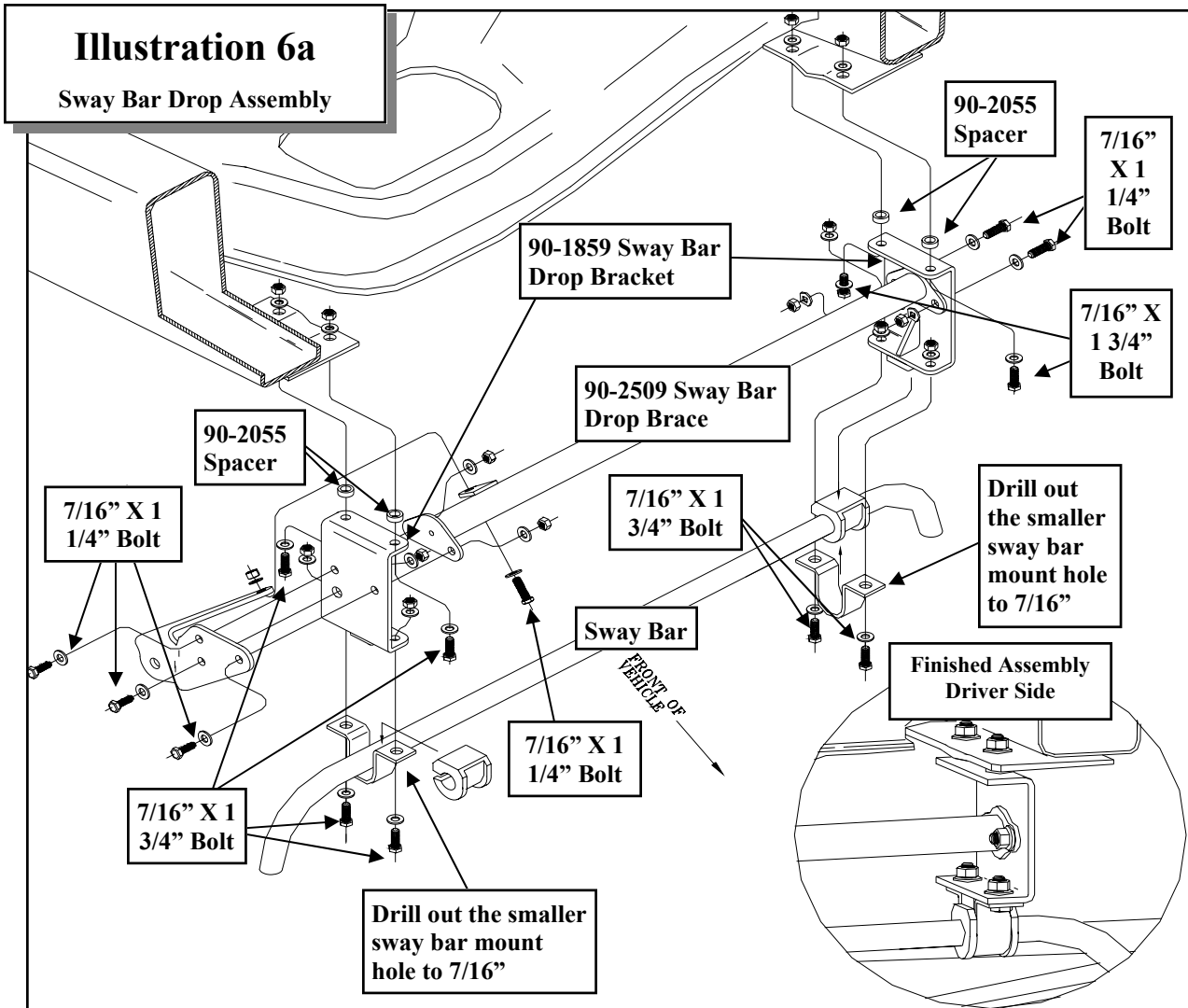

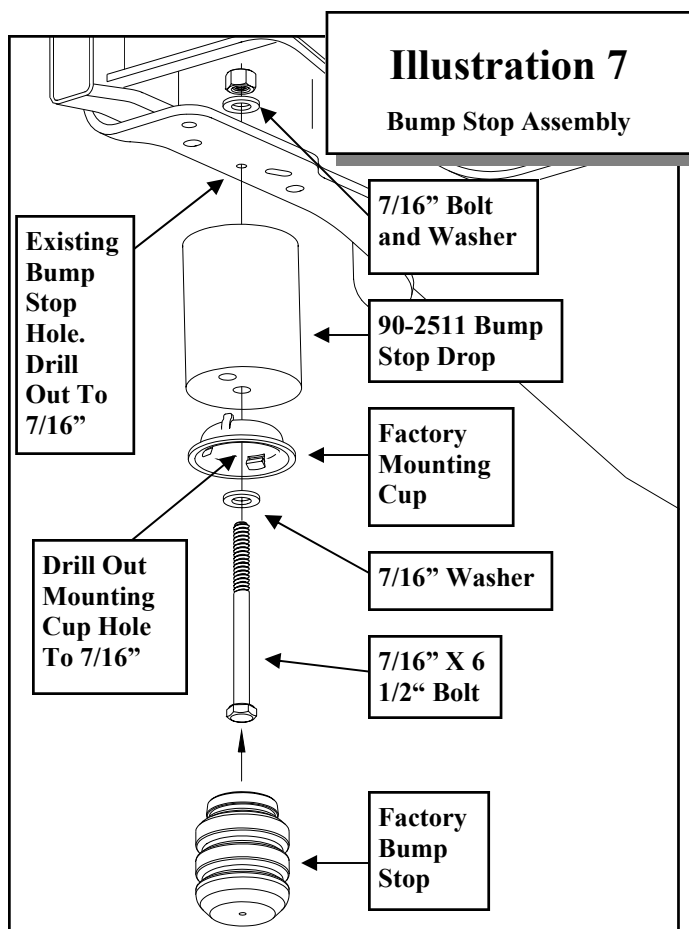

Illustration 7
Bump Stop Assembly

Existing Bump Stop Hole. Drill Out To 7/16"

Drill Out Mounting Cup Hole To 7/16"

7/16" Bolt and Washer

90-2511 Bump Stop Drop

Factory Mounting Cup

7/16" Washer

7/16" X 6 1/2" Bolt

Factory Bump Stop

hardware. Use (1) 7/16" X 1 1/4" and hardware to bolt the steering stabilizer bracket to the tab on the sway bar support tube. See ILLUSTRATION 6b.

NOTE: If installing a PRO COMP double shock hoop kit skip the following step.

41. Bolt the factory sway bar to the drop brackets using the (4) 7/16" X 1 3/4" bolts and hardware. See ILLUSTRATION 6a.

NOTE: The smaller hole on each factory sway bar mount needs to be drilled out to 7/16" to accommodate the supplied 7/16" bolts.

42. Torque all 7/16" sway bar hardware to 50 ft. lbs.
43. On the driver side, unbolt the bump stop mounting cup and drill out the factory hole in the frame and bump stop mounting cup to 7/16".

44. On the passenger side, unbolt the bump stop mounting cup. Measure in toward the engine 5/8" from the center of the factory bump stop hole in the frame. Center punch and drill and the new hole 7/16" in the frame. Drill out the bump stop mounting cup to 7/16".

NOTE: If installing a PRO COMP double shock hoop kit do so at this time.

45. Use the supplied 7/16" X 6 1/2" bolt and hardware to bolt the bump stop drop (90-2511) and mounting cup to the bump stop hole in frame. See ILLUSTRATION 7.

NOTE: Be sure to fit the tab from the mounting cup into the hole in the drop.

46. Reinstall the previously removed factory bump stop into the mounting cup on the new bump stop drop. See ILLUSTRATION 7.
 47. Using the factory isolators install the supplied front coil springs (24514 Gas or 24515 Diesel) into the spring buckets and raise the axle into place. Make sure the coil spring seats properly on the lower spring perch.
 48. Install the new shocks (PN 926553 or MX6122). Torque the upper mounting hardware to 46 ft. lbs. and the lower mounting hardware to 111 ft. lbs. Use thread locker on these bolts.
 49. Install draglink end into pitman arm and torque draglink nut to 148 ft. lbs. Reinstall cotter pin.
 50. Install the steering stabilizer stem to the new pro comp bracket (90-3198) using the previously removed OE hardware. See ILLUSTRATION 6b.
- NOTE: If installing a PRO COMP double shock hoop kit skip the following step.**
51. Re-attach the sway bar to the sway bar end links and fasten to 111 ft. lbs.
 52. On the driver side, re clip the axle vent line on the frame providing adequate slack for

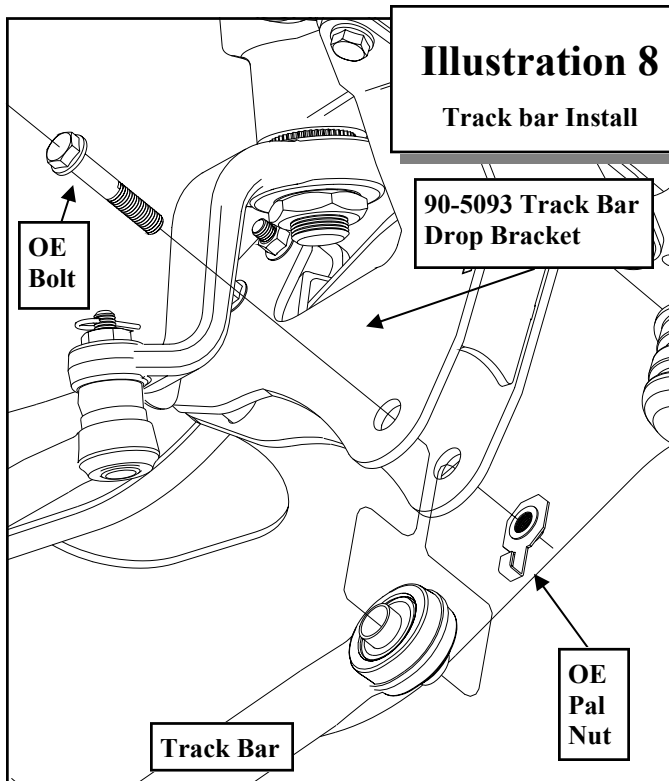

Illustration 8

Track bar Install

vehicle to the ground. Torque to manufacturers specs.

58. Torque the **OE** rear Radius arm bolts to 222 ft. lbs.
59. Reinstall the track bar into the Pro Comp track bar bracket (**90-5093**) using the **OE** bolt. Torque to 406 ft. lbs. See ILLUSTRATION 8.

NOTE: You may find that having someone inside the vehicle and moving the steering wheel from side to side will aid in the alignment of the track rod. **DO NOT** start the engine for this! You only have to move it enough to line the holes up on the track bar mount.

60. On both sides of the vehicle, check the routing of the brake lines and the ABS wire harnesses. There must be no pinching, rubbing, or stretching of either component. At full droop, cycle the steering from lock to lock while observing the reaction of these components. Reposition them if needed.

the line at full droop.

53. On the passenger side, reposition the clip on the axle hub vacuum line to provide adequate slack to re-clip the line to the existing hole on the outside of the bump stop plate.

NOTE: Be sure that the newly re-routed vent line does not interfere with the travel of the bump stop.

54. Fasten the ABS wiring clips to the tabs on the backside of the radius arms using the **OE** bolts.

NOTE: Use silicone to seal the ABS line push clip to the hole on the top of the Radius arm.

55. Remove the ABS line from the inner fender. Drill a new hole, using a $15/64$ " bit, **3"** lower in the fender to provide adequate slack for line and reattach the ABS line.
56. Refasten the lower brake line mount to the lower coil spring perch using the **OE** hardware.
57. Reinstall the front wheels and lower the

NOTES:

- ⇒ On completion of the installation, have the suspension and headlights re-aligned.
- ⇒ After 100 miles recheck for proper torque on all newly installed hardware.
- ⇒ Recheck all hardware for tightness after off road use.

Rear Installation:

1. Block the front tires and raise the rear of the vehicle. Support the frame with jack stands forward of the rear springs.
2. Remove the wheels and tires.
3. Remove the shocks on both sides of the vehicle. It may be necessary that you slightly raise the axle to unload the shocks for removal.
4. On the driver side, unbolt the emergency brake line bracket from the upper spring plate.
5. If your vehicle is equipped with factory sway bar, unbolt it from the end links.
6. Support the rear axle with a floor jack and remove the **U-bolts** on the driver side. Slightly loosen the **U-bolts** on the passenger side.
7. Lower the rear axle and remove the factory block.

NOTE: *Be sure not to over extend the rear brake line and rear axle vent line.*

8. While supporting the rear leaf spring, remove the factory spring mounting bolts and remove the leaf spring from the driver side only at this time.
9. The heavy factory leaf on the bottom of the leaf pack and the upper overload spring must be removed and used on the new Pro Comp rear leaf spring. Use C-clamps to hold the leaves together. Make note of the direction of the arch and the offset of the centering hole (long end forward/back etc.). Remove the **OE** center bolts and separate the spring pack.
10. Install the heavy leaf on the bottom of the new Pro Comp spring pack (**PN 22415**). Install the overload with the spacer at the top of the Pro Comp spring, use the new center bolt and lock nut from pack (**90-6337**) if needed, again use C-clamps to

assist in the assembly. See ILLUSTRATION 9.

NOTE: *Top spring plate center hole needs to be drilled out to 3/4" to clear nut from pack (90-6337) if the factory overload set up is not used.*

11. Install the spring pack to the hangers using the factory hardware. Do not torque at this time.

NOTE: *If installing traction bar kit 72099 install the rear mount at this time.*

APPLICATIONS:

* **INSTALL THE LEAF SPRING (22415) WITH THE FACTORY OVERLOAD LEAVES IF EQUIPPED FROM THE FACTORY.**

* **IF NEEDED THE 1" ALUMINUM BLOCK (95-100F).**

See ILLUSTRATION 9.

12. If needed insert the supplied 1" (**95-100F**) aluminum lift block. Make sure the pin fits into the hole on the spring perch. Use your floor jack to raise the axle to the spring making sure the pin on the leaf spring assembly fits into the hole on the lift block. Secure the assembly with the **5/8" U-bolts (PN 13-90190)**, **5/8" hi-nuts (PN 20-65471)** and washers supplied. Do not torque the hi-nuts at this time. See ILLUSTRATION 9.

NOTE: *Make sure the block sits flush on the axle perch.*

13. Bolt the emergency brake line bracket back on to the upper spring plate.
14. Repeat the installation on the other side of the vehicle.
15. Install your new Pro Comp shocks (**PN 932008 or MX6018**). Torque the upper mounting hardware to 46 ft. lbs. and the

Illustration 9

22415 Rear Leaf Spring Installation

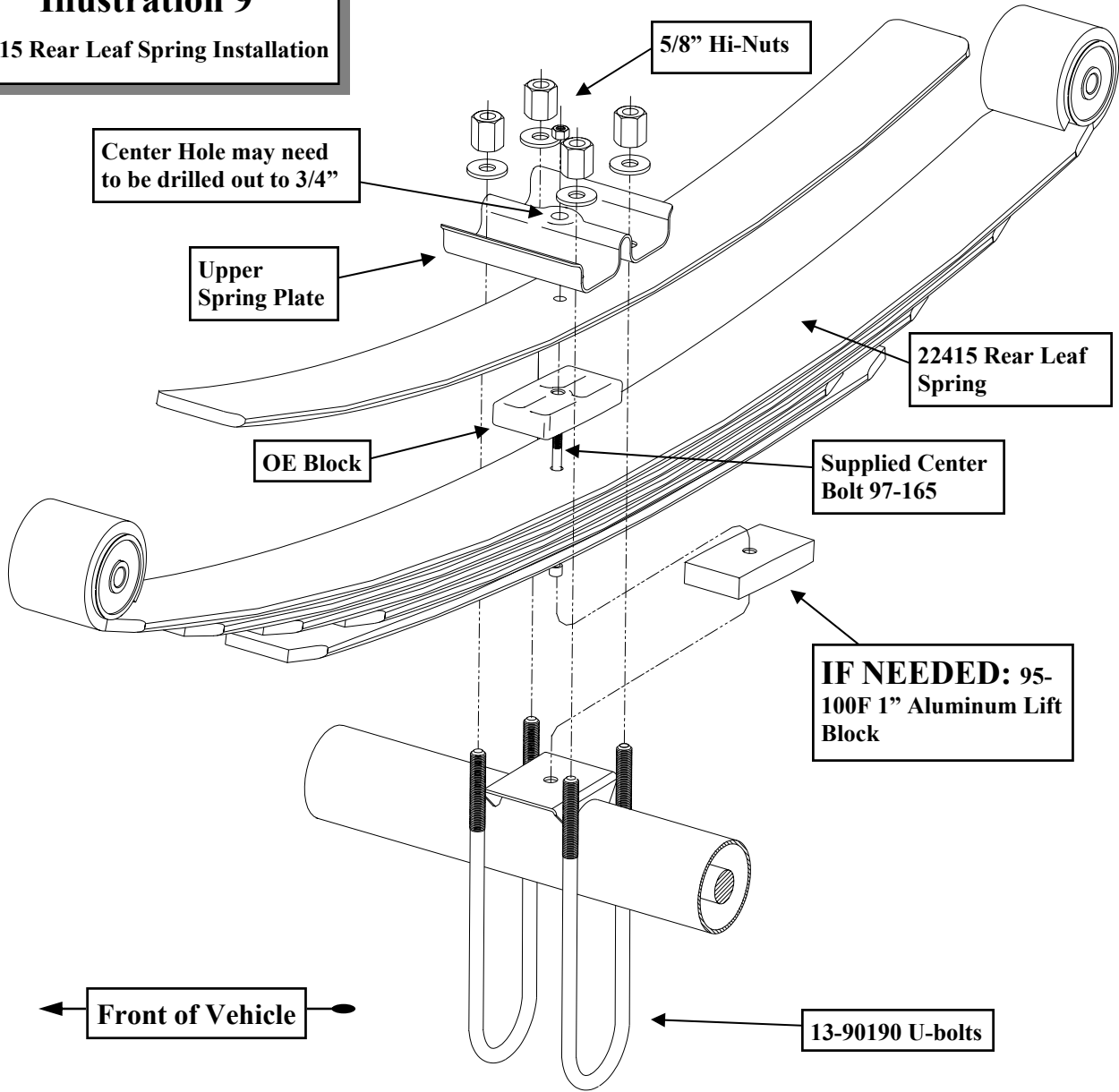

Rear Spacer Options

1. Install the leaf spring (22415) with the factory overload leaves if equipped from the factory.
2. If needed insert 1" aluminum lift block (95-100f).
See Inset box after step 11.

- lower mounting hardware to 66 ft. lbs.
Use thread locker on these bolts.
16. Reinstall the wheels and tires and lower the vehicle to the ground. Torque lug nuts to manufacturers specifications.
 17. Torque the spring mounts at this time. The front bolts are torqued to 250 ft. lbs. and the rear bolts are torqued to 185 ft. lbs. Torque the **5/8" U-bolts** to 120 ft. lbs.
 18. If vehicle came equipped with a rear sway bar, Re-attach the rear sway bar to the end links. Secure with the previously removed **OE** hardware.
 19. Re-check the wheel lug torque on all four wheels at this time.
 20. Re-check all hardware (both the front and the rear) for proper installation and torque!!
 21. If you wish, you may trim the excess u-bolt thread length. If you do this you should leave approximately one inch of thread exposed after the **U-bolts** are torqued.
 22. On both sides of the vehicle, check the routing of the brake lines and the ABS wire harnesses. There must be no pinching, rubbing, or stretching of either component. Reposition them if needed.

NOTES:

- ⇒ **On completion of the installation, have the suspension and headlights re-aligned.**
- ⇒ **After 100 miles recheck for proper torque on all newly installed hardware.**
- ⇒ **Recheck all hardware for tightness after off road use.**

Use this only as a guide for hardware without a called out torque specification in the instruction manual.

Bolt Torque and ID						
Decimal System			Metric System			
All Torques in Ft. Lbs. Maximums						
Bolt Size	Grade 5	Grade 8	Bolt Size	Class 9.8	Class 10.9	Class 12.9
5/16	15	20	M6	5	9	12
3/8	30	45	M8	18	23	27
7/16	45	60	M10	32	45	50
1/2	65	90	M12	55	75	90
9/16	95	130	M14	85	120	145
5/8	135	175	M16	130	165	210
3/4	185	280	M18	170	240	290

<p>1/2-13x1.75 HHCS</p> <p>D T L X</p>	<p>Grade 5 Grade 8 (No. of Marks + 2)</p>	<p>M12-1.25x50 HHCS</p> <p>D T L X</p>
<p>G = Grade (Bolt Strength) D = Nominal Diameter (Inches) T = Thread Count (Threads per Inch) L = Length (Inches) X = Description (Hex Head Cap Screw)</p>		<p>P = Property Class (Bolt Strength) D = Nominal Diameter (Millimeters) T = Thread Pitch (Thread Width, mm) L = Length (Millimeters) X = Description (Hex Head Cap Screw)</p>

Notice to Owner operator, Dealer and Installer:

Vehicles that have been enhanced for off-road performance often have unique handling characteristics due to the higher center of gravity and larger tires. This vehicle may handle, react and stop differently than many passenger cars or unmodified vehicles, both on and off-road. You must drive your vehicle safely! Extreme care should always be taken to prevent vehicle rollover or loss of control, which can result in serious injury or even death. Always avoid sudden sharp turns or abrupt maneuvers and allow more time and distance for braking! Pro Comp reminds you to fasten your seat belts at all times and reduce speed! We will gladly answer any questions concerning the design, function, maintenance and correct use of our products.

Please make sure your Dealer/Installer explains and delivers all warning notices, warranty forms and instruction sheets included with Pro Comp product.

Application listings in this catalog have been carefully fit checked for each model and year denoted. However, Pro Comp reserves the right to update as necessary, without notice, and will not be held responsible for misprints, changes or variations made by vehicle manufacturers. Please call when in question regarding new model year, vehicles not listed by specific body or chassis styles or vehicles not originally distributed in the USA.

Please note that certain mechanical aspects of any suspension lift product may accelerate ordinary wear of original equipment components. Further, installation of certain Pro Comp products may void the vehicle's factory warranty as it pertains to certain covered parts; it is the consumer's responsibility to check with their local dealer for warranty coverage before installation of the lift.

Warranty and Return policy:

Pro Comp warrants its full line of products to be free from defects in workmanship and materials. Pro Comp's obligation under this warranty is limited to repair or replacement, at Pro Comp's option, of the defective product. Any and all costs of removal, installation, freight or incidental or consequential damages are expressly excluded from this warranty. Pro Comp is not responsible for damages and / or warranty of other vehicle parts related or non-related to the installation of Pro Comp product. A consumer who makes the decision to modify his vehicle with aftermarket components of any kind will assume all risk and responsibility for potential damages incurred as a result of their chosen modifications. Warranty coverage does not include consumer opinions regarding ride comfort, fitment and design. Warranty claims can be made directly with Pro Comp or at any factory authorized Pro Comp dealer.

IMPORTANT! To validate the warranty on this purchase please be sure to mail in the warranty card.

Claims not covered under warranty-

- Parts subject to normal wear, this includes bushings, bump stops, ball joints, tie rod ends and heim joints
 - Discontinued products at Pro Comp's discretion
- Bent or dented product
- Finish after 90 days
- Leaf or coil springs used without proper bump stops
- Light bulbs
- Products with evident damage caused by abrasion or contact with other items
- Damage caused as a result of not following recommendations or requirements called out in the installation manuals
- Products used in applications other than listed in Pro Comp's catalog
- Components or accessories used in conjunction with other manufacturer's systems
- Tire & Wheel Warranty as per Pro Competition Tire Company policy
- Warranty claims without "Proof of Purchase"
- Pro Comp Pro Runner coil over shocks are considered a serviceable shock with a one-year warranty against leakage only. Rebuild service and replacement parts will be available and sold separately by Pro Comp. Contact Pro Comp for specific service charges.
- Pro Comp accepts no responsibility for any altered product, improper installation, lack of or improper maintenance, or improper use of our products.

E-Mail: tech@explorerprocomp.com
Website: www.explorerprocomp.com
Fax: (619) 216-1474
Ph: (619) 216-1444

PLACE
WARRANTY REGISTRATION
NUMBER
HERE: _____