

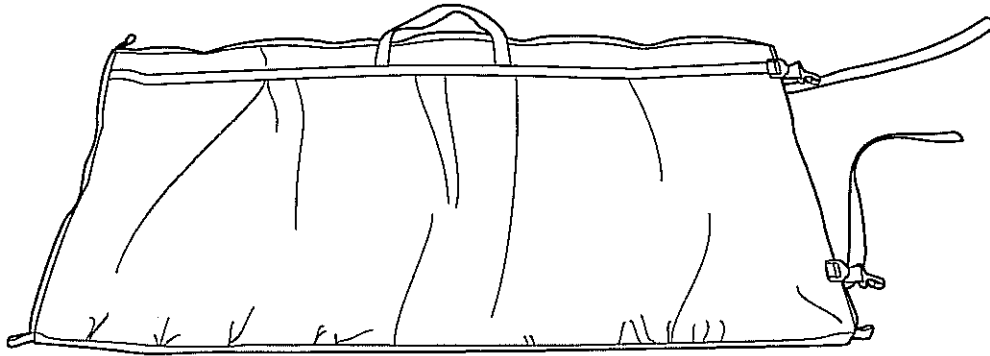

# JK WRANGLER

## 3 Compartment Bag



82210326



**K6860048**

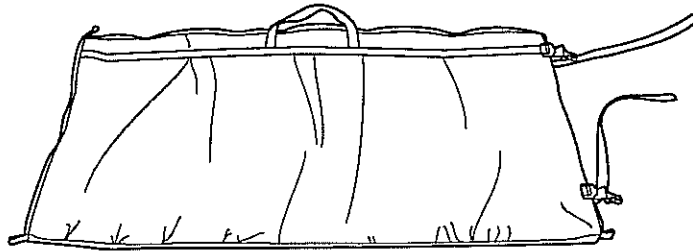

**A**

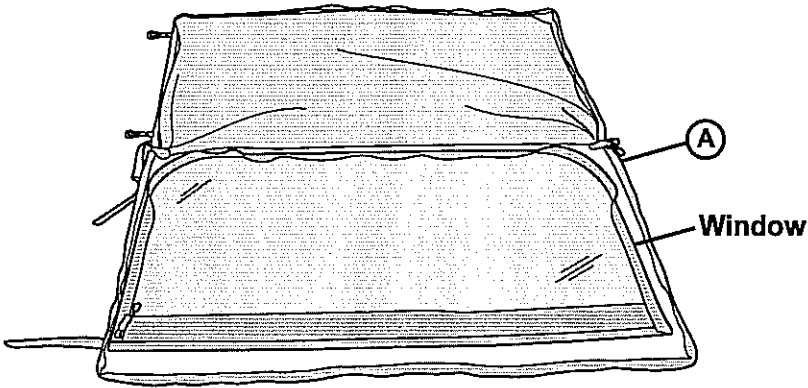

**1**

**Lay bag out flat.**

**Lay one window flat.**

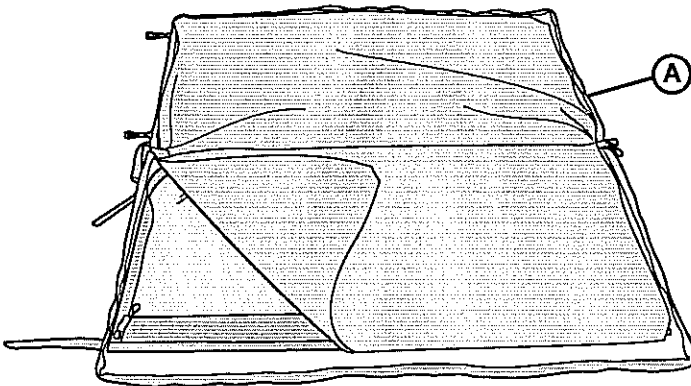

**2**

**Place protective cover over window.**

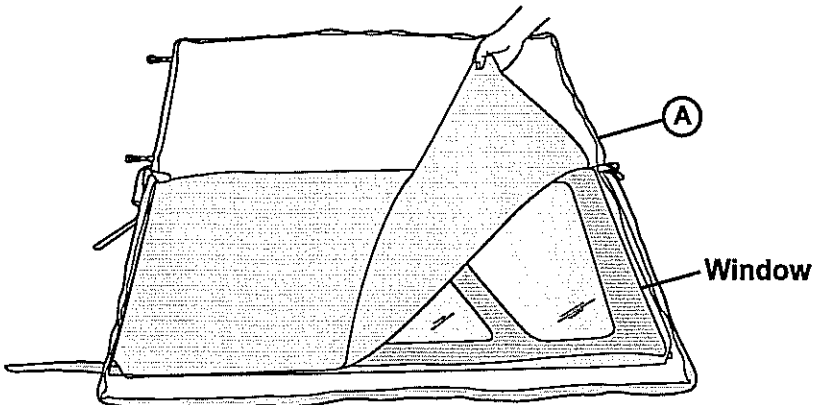

**3**

**Add additional windows with protective cover between each layer.**

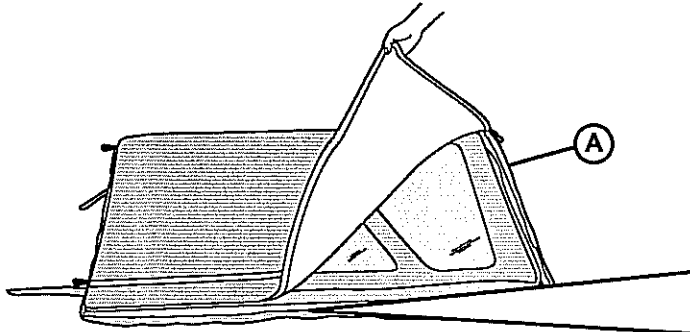

**Fold outer flap over and zip closed.**

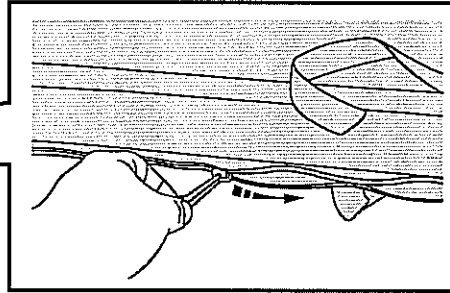

**4**

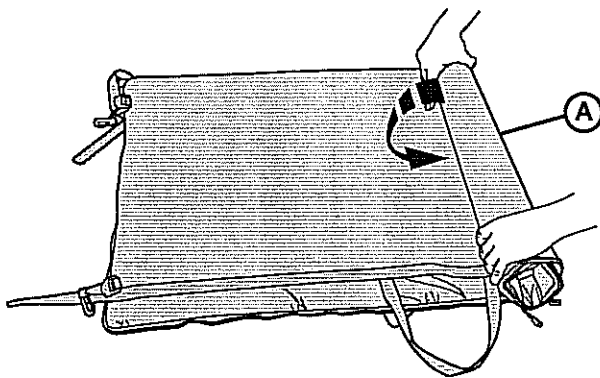

**Roll bag as tight as possible.**

**5**

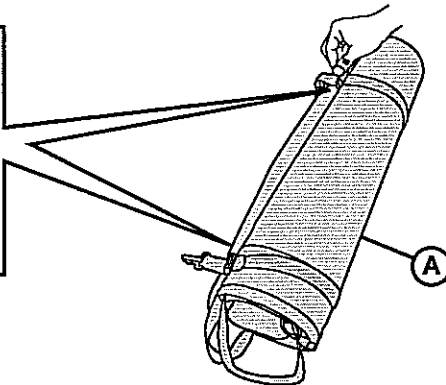
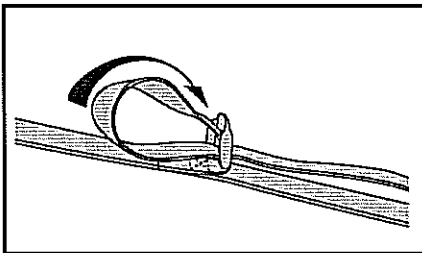

**Thread straps through buckles and pull tight.**

**6**

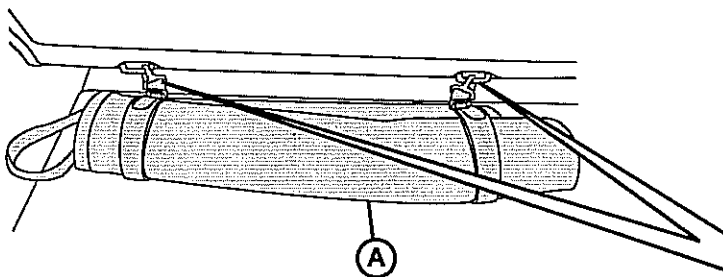

**Clip bag to child restraint brackets on back of seat.**

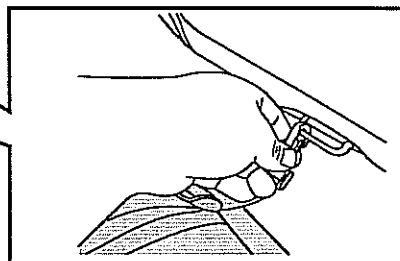

**7**



# JK WRANGLER

Sac à 3 compartiments

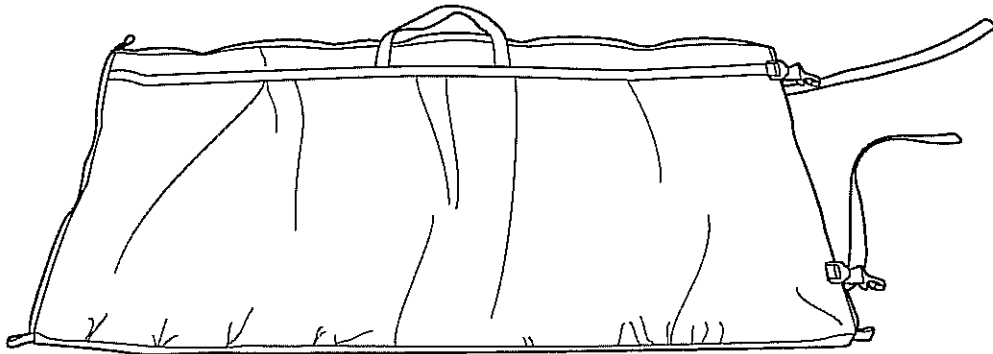

82210326

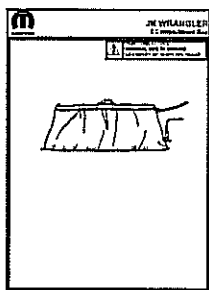

K6860048

A

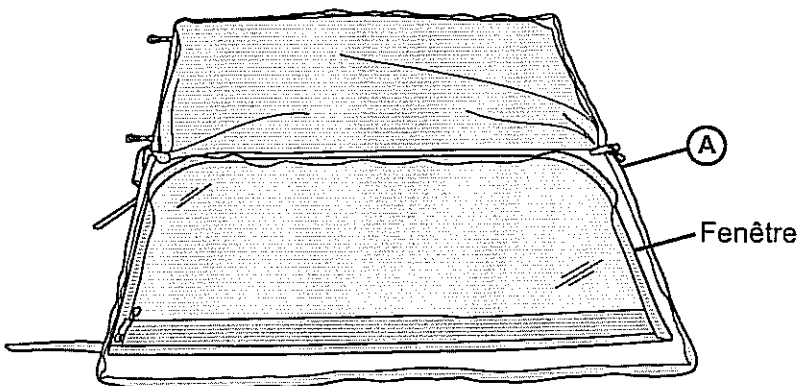
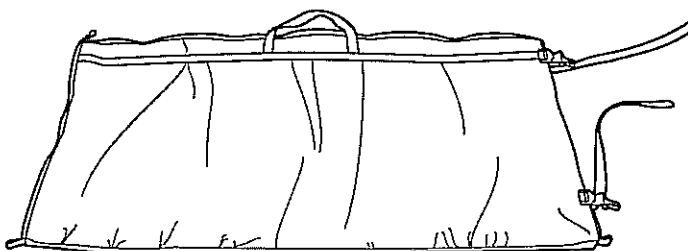

1

Étaler le sac à plat.

Étaler une fenêtre à plat.

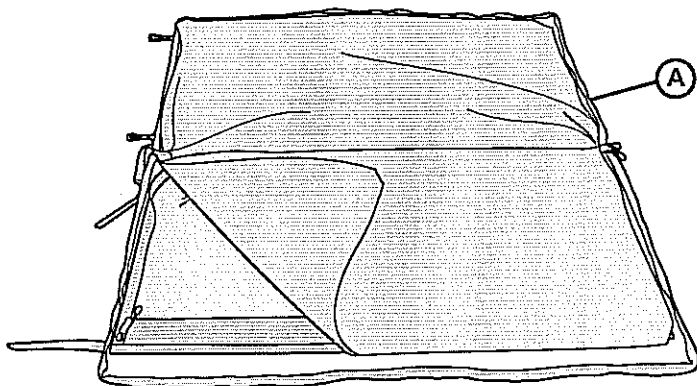

2

Placer la housse de protection par-dessus la fenêtre.

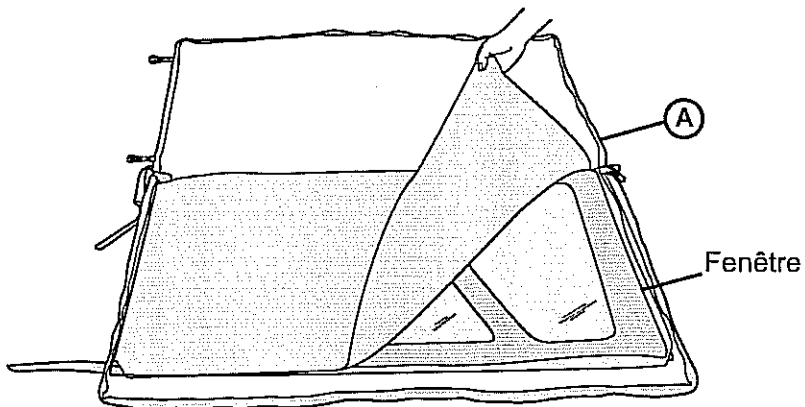

3

Ajouter des fenêtres additionnelles avec une housse de protection entre les couches.

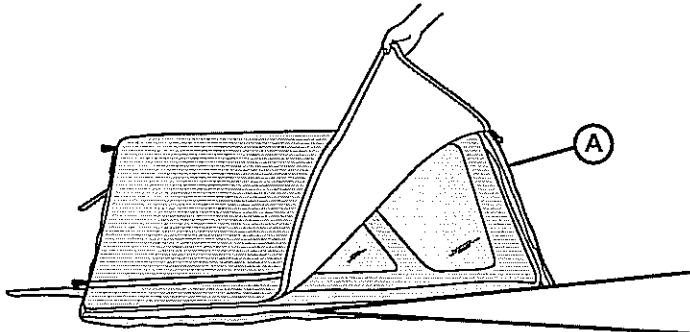

Plier le rabat extérieur par-dessus et fermer avec la fermeture à glissière.

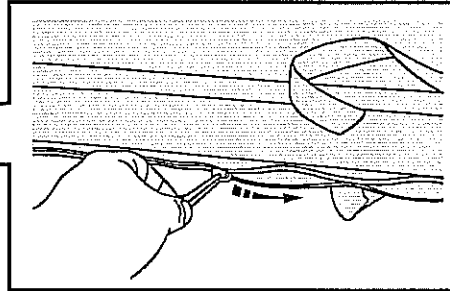

**4**

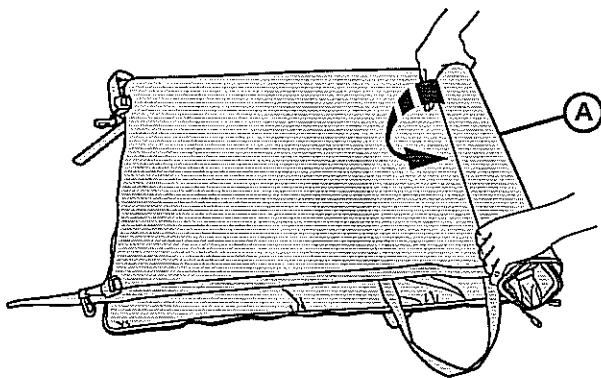

Rouler le sac le plus étroitement possible.

**5**

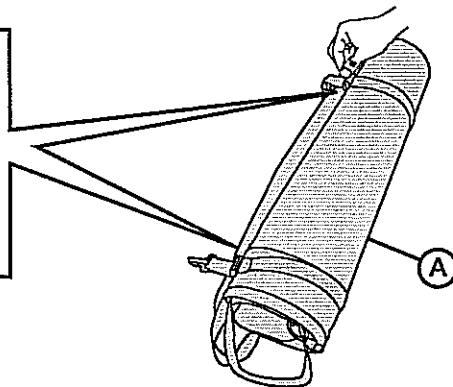
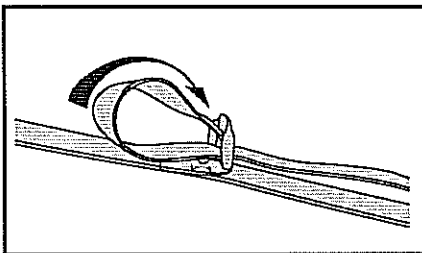

Passer les sangles dans les boucles et tirer pour serrer.

**6**

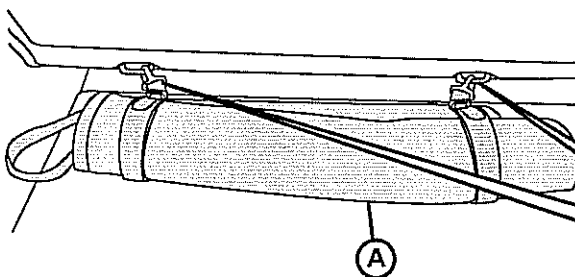

Fixer le sac aux supports de retenue à l'arrière du siège.

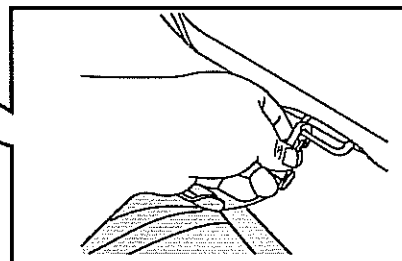

**7**



# JK WRANGLER

Bolso de 3 Compartimientos

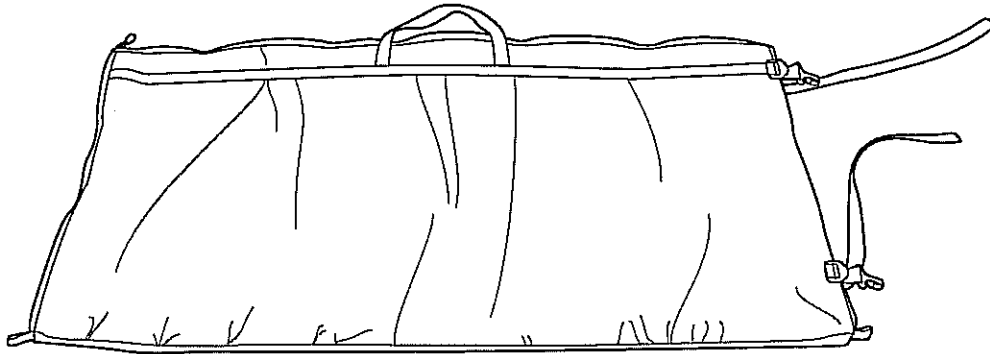

82210326



**K6860048**

**A**

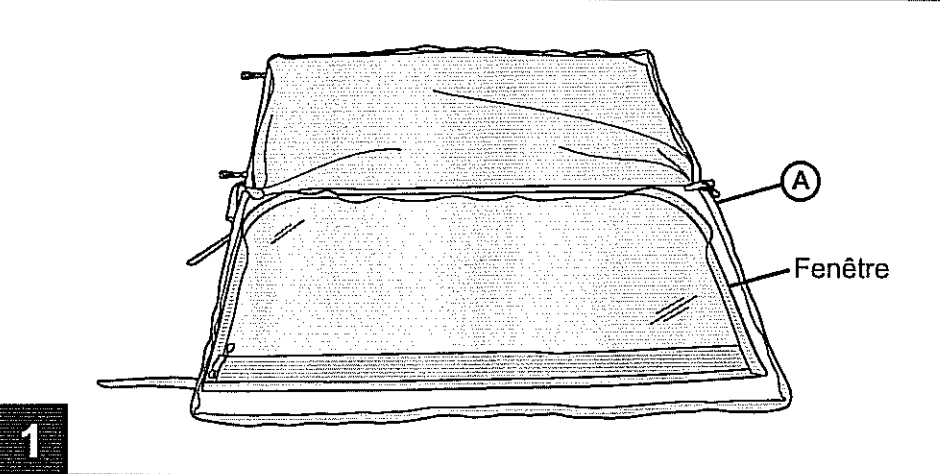
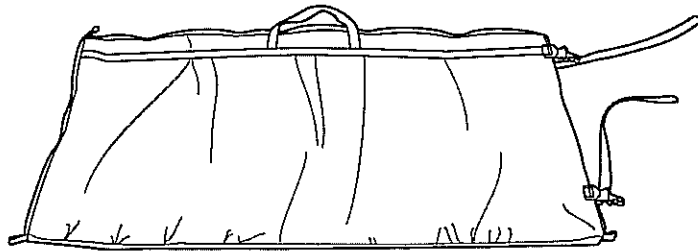

**Extienda el bolso completamente.**

**Extienda una ventana completamente**

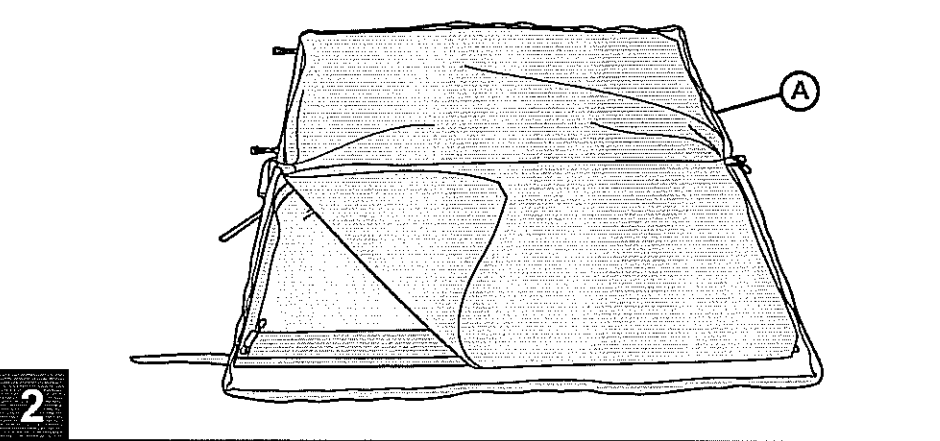

**Coloque la cubierta protectora sobre la ventana.**

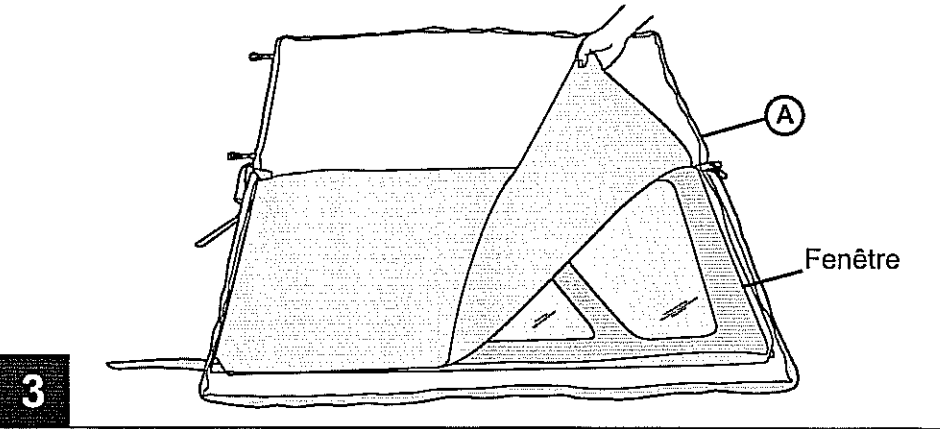

**Agregue ventanas con la cubierta protectora entre cada capa**



**Doble y enfunde la cubierta exterior y cierre la cremallera.**

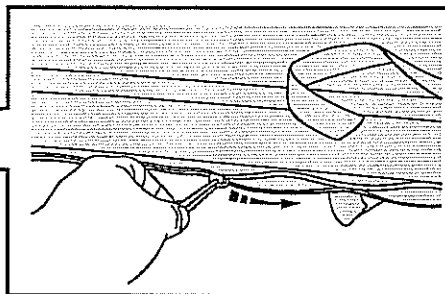
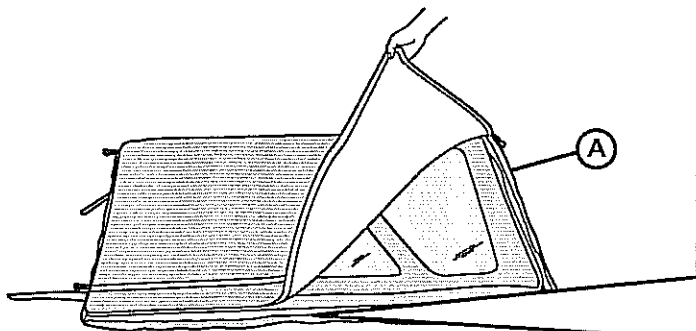

**4**

**Enrolle el bolso lo más compacto posible.**

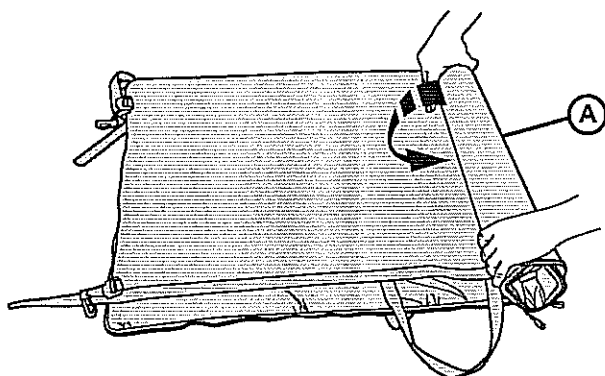

**5**

**Haga pasar las correas por las hebillas y jale para tensar y ajustar.**

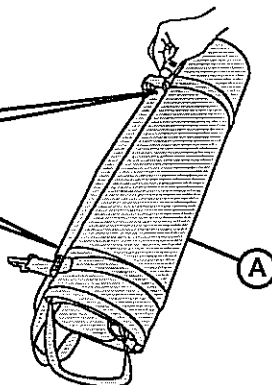
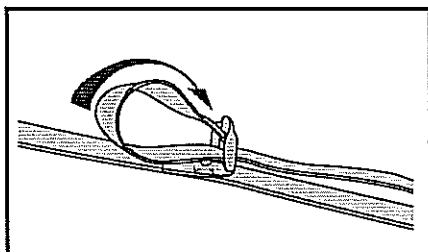

**6**

**Enganche el bolso a los seguros para niños en la parte de atrás de los asientos.**

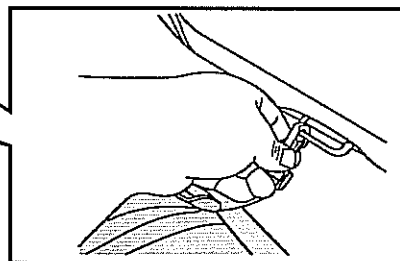
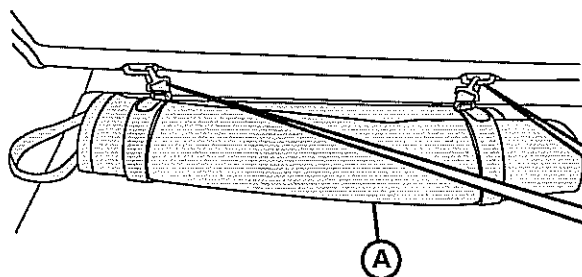

**7**