



BESTOP

Sailcloth Fabric Replacement Top and Doors with Tinted Side and Rear Curtains Installation Instructions

For: Wrangler/TJ 1997 - 2002 Part Number: 79124

This product is only designed for the vehicles listed above. DO NOT INSTALL THIS PRODUCT ON ANY VEHICLE OTHER THAN THOSE LISTED ABOVE. Failure to install this product on the proper vehicle could cause injury to the vehicle occupants and damage to the product.

WARNING

This product is designed to enhance the appearance of the vehicle. Do not rely in any way on the components of this product to contain occupants within the vehicle, or to protect against injury or death in the event of an accident. This top will not protect the occupants from falling objects. Never operate vehicle in excess of manufacturer's specifications.

WEAR SEAT BELTS AT ALL TIMES

Read and follow, precisely, all installation instructions provided when installing top. Failure to do so may result in a poor fitting top and could place occupants of the vehicle in a potentially dangerous situation. Failure to properly install or reinstall this product may cause the top or a component part to come off the vehicle, potentially causing an accident and possible injury to the occupants of the vehicle. After installing or reinstalling the top, check to make sure it has been properly installed.

Installation Tips

Before you begin installing this top assembly, read all instructions thoroughly. After completing the installation, keep these instructions for further reference. Below are a few tips to make this installation easier.

For a smooth fit:

For ease in installation, the top should be installed at temperatures above 72° F. Below this temperature, the fabric may contract an inch or more, making it difficult to fit to the vehicle.

It is normal for a top to contract and wrinkle when stored in the shipping carton. Within a few days after the installation, the top will relax and the wrinkles will disappear.

Removing the Old Top

Parts List

Fabric Top	Qty - 1
Quarter Window, Right	Qty - 1
Quarter Window, Left	Qty - 1
Rear Window	Qty - 1
Door Cover, Right	Qty - 1
Door Cover, Left	Qty - 1

Tools Needed
 Shoe Horn
 Safety Glasses
 Razor Knife
 Phillips Screwdriver

Caution

Safety glasses should be worn at all times while installing this product.

Step One

Remove the Quarter Windows and the Rear Window. Remove the metal Tailgate Bar from the bottom of the Rear Window and set it aside.

Release the plastic strip sewn to the top above the doors. Pull down and out to slip the plastic out of the channel.

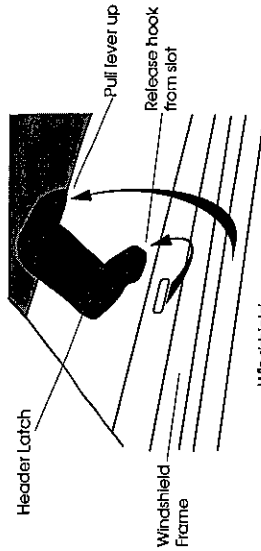
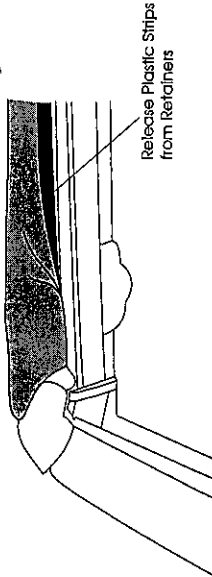

Step Two

Release the latch that secures the header to the windshield. Pull up on the lever and then down and out to release the hook from the slot in the windshield frame.

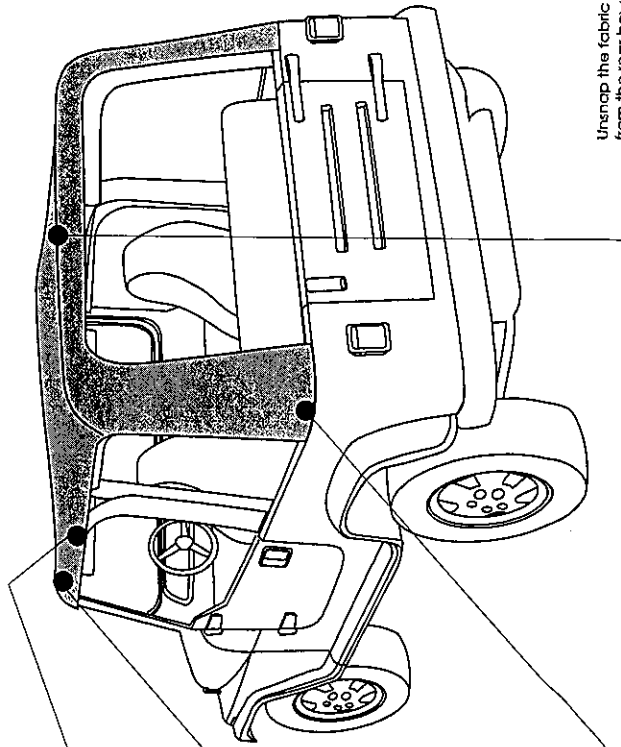

Unsnap the fabric from the rear bow

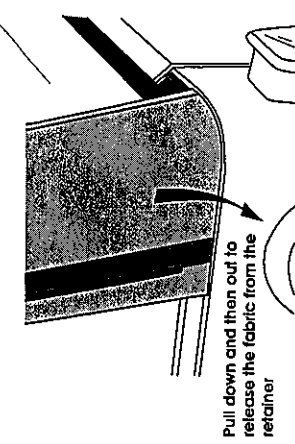
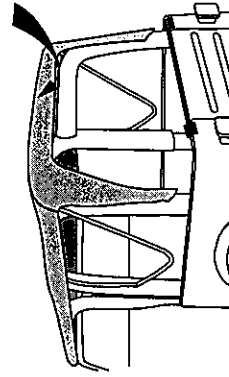

Step Four

Unsnap the fabric from the rear bow and allow the bow to drop onto the tailgate.

Step Three

Release the rear corners of the top. Pull gently down and then out to release the plastic strip from the retainer on the vehicle.

Step Five

Unfasten the flap around the middle bow.

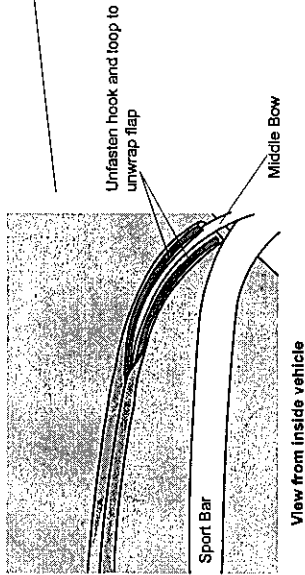

Step Six

Collapse the bow assembly down onto the tailgate.

With the bow assembly laying on the tailgate, remove the screws that fasten the fabric to the corners of the header. Set the screws aside for use in installing the new top fabric.

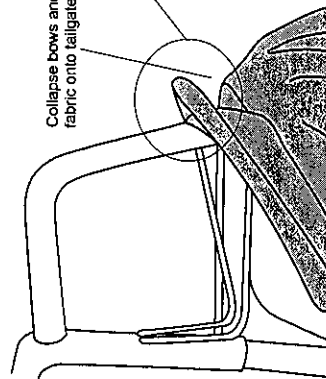

Detail of Header

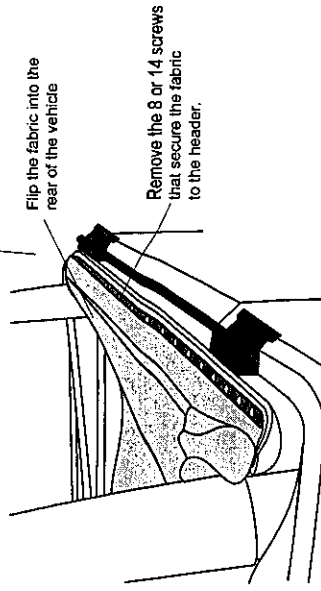
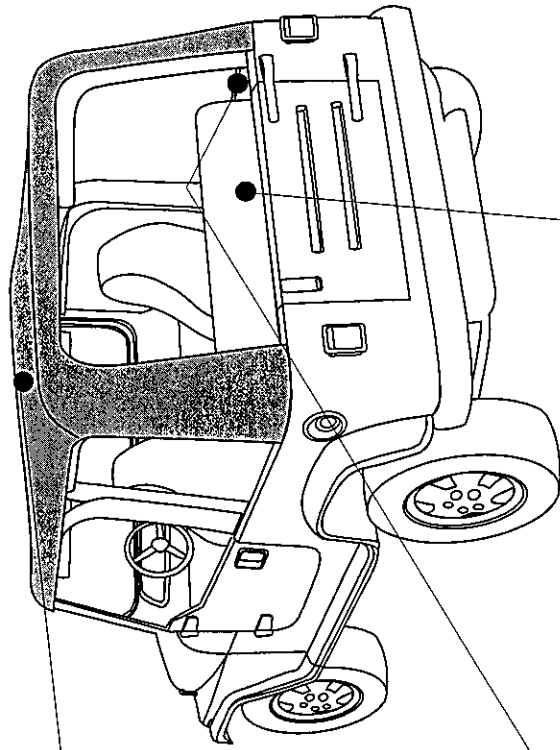
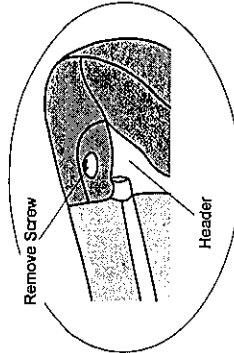

Step Seven

Flip the top fabric back over into the rear of the vehicle (so that the fabric lays backing side up) to expose the plastic strip along the edge of the fabric. Remove the eight or fourteen screws that secure the fabric to the header, setting the screws aside for use in installing the new top. Then remove the old top fabric from the vehicle.

Manufacturing Note: Due to a recent header assembly modification by Daimler Chrysler, the plastic strip on the windshield header may have 8 screw locations instead of 14. Both attachment numbers of screws will securely fasten the header and perform as the original design was intended.

Installing the New Top

Step One

If you have a 1997 vehicle with a slip-on plastic extrusion on the door surround, it must be removed. Pull down on the extrusion to work it loose.

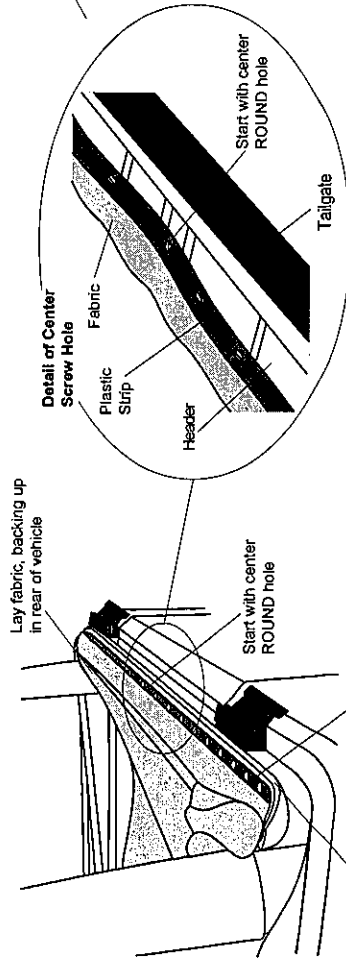
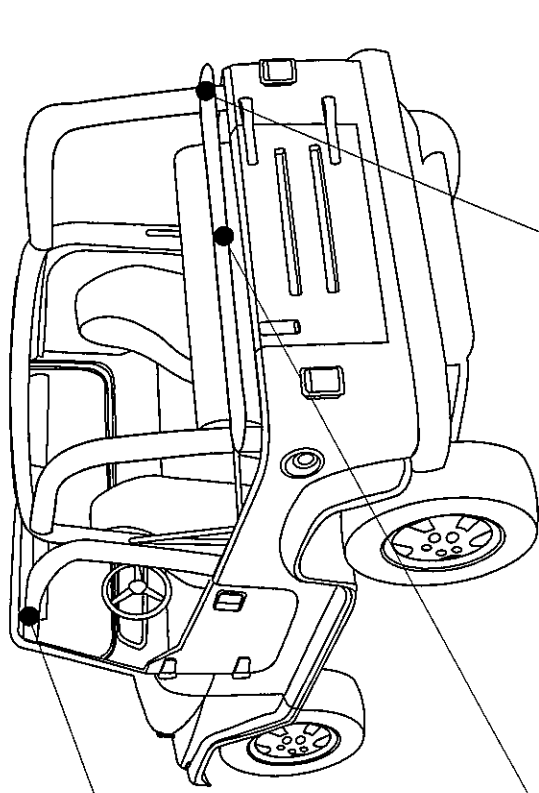
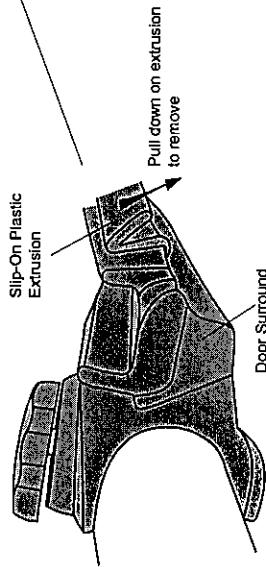

Step Two

In order to install the top fabric, make sure that the Center and Rear Bows are in the folded down position on the rear of the vehicle.

Lay the top fabric, backing side up in the rear of the vehicle with the plastic strip facing up and aligned with the front edge of the header. Locate the round hole that marks the center of the plastic strip (all other holes are slotted). Install a screw in the round hole to secure the fabric to the header as well as to center the top. Then proceed to install screws in the remaining seven or thirteen holes along the front of the header.

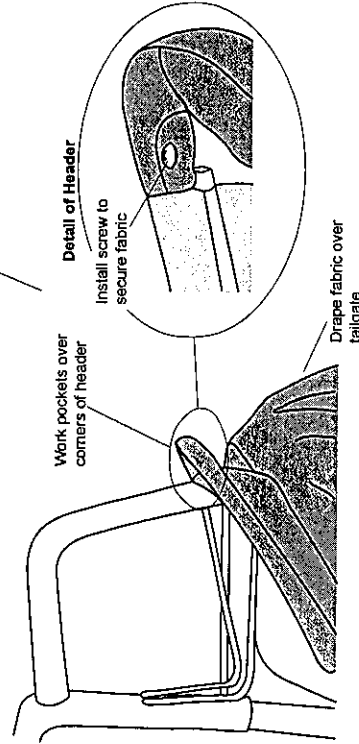

Step Three

Flip the fabric over so that it wraps around the header and drape the top fabric over the tailgate. Raise the header slightly and work the pockets in the fabric over the corners of the header. Install an oval head screw in each corner to secure the fabric to the header.

Step Four

Raise the header and bow assembly toward the windshield and into position.

Inside the top, snap the fabric to the Rear Bow (six snaps).

Snap fabric to Rear Bow

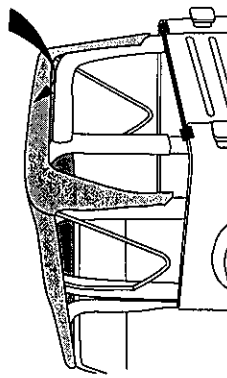

Step Five

Close the header latches to secure the front of the top to the windshield. Catch the hook in the slot in the windshield frame and then close the lever over it so that it lays flat against the windshield frame.

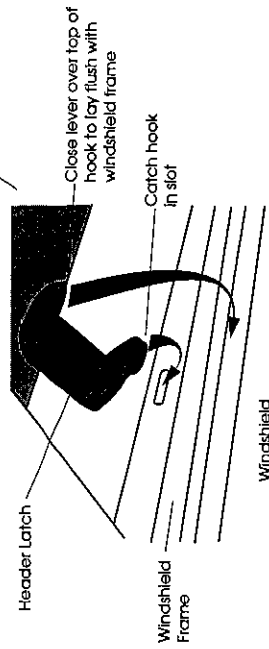

Pull down gently on the Rear Bow and slip plastic into retainer

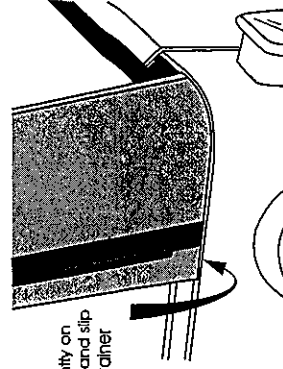

Step Six

Make sure that the Center Bow is centered in the hook and loop flap inside the top. Do not fasten the flap at this time.

Pull down gently on the Rear Bow and work the plastic sewn to the rear corners of the top into the retainer on the vehicle.

Step Seven

Wrap the hook and loop flap inside the top around the Center Bow and fasten it to itself.

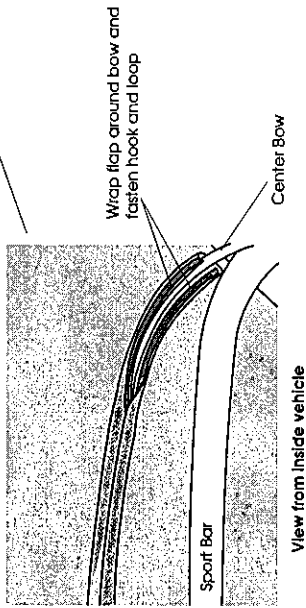

Step Eight

Locate the left and right Quarter Panels and orient them with the zipper along the top and rear of the panel. Start the zipper at the front top corner of the Quarter Panel, next to the door. Hold the end of the zipper and close the zipper slider 10" - 12" along the top of the panel.

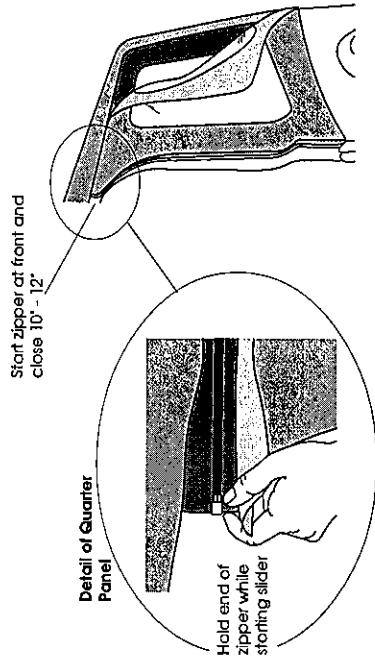

Step Nine

Roll the plastic along the front of the Quarter Panel into the channel of the Door Surround on the vehicle.

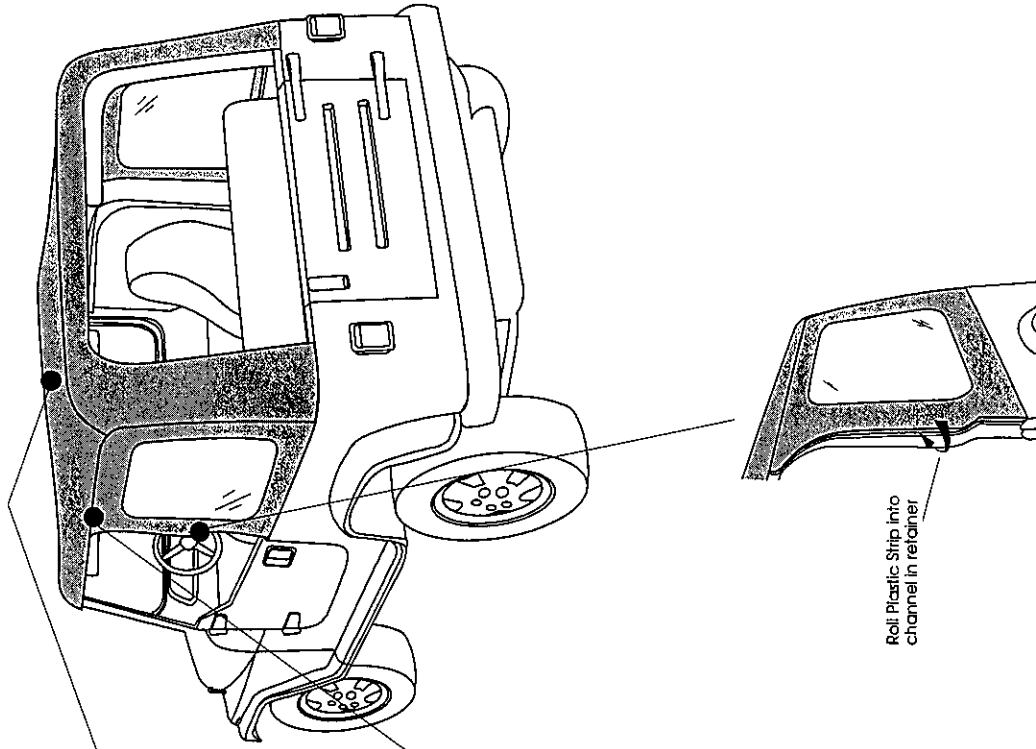

Step Ten

Locate the two plastic strips sewn to the sides of the top, above each door. Slip the strips into the channel in the Door Surround above the door opening. It is easiest to insert the front plastic strip into the channel first.

Roll Plastic Strips into channel above door opening

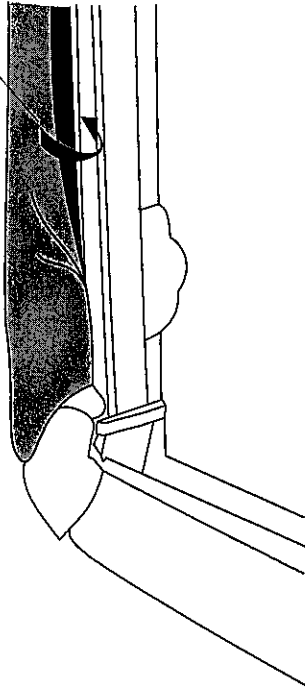

Step Eleven

Close the zippers on the Quarter Panels the rest of the way to the lower rear corner of the panel.

Start at the rear and roll the plastic along the bottom of the panel into the retainer on the vehicle. Then fasten the hook and loop strips along the top and rear of the panel to the top.

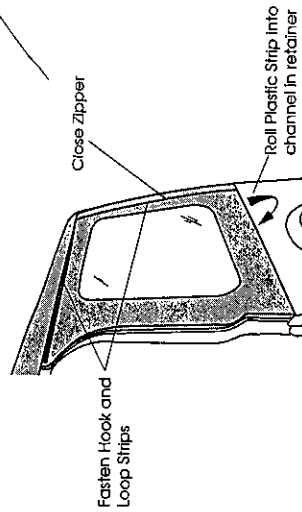

Fasten Hook and Loop Strips

Close zipper

Roll Plastic Strip into channel in retainer

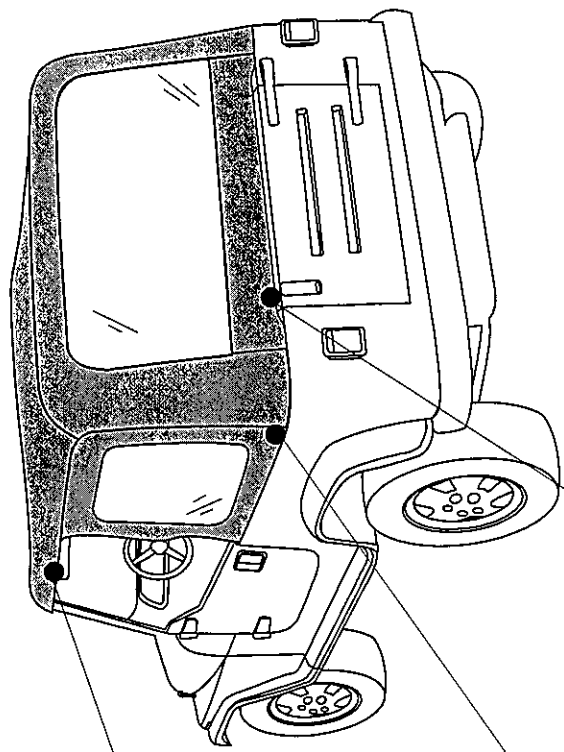

Tailgate Retainer

Tailgate Retainer channel

Rear Window - Backing Side

Tubed Strip

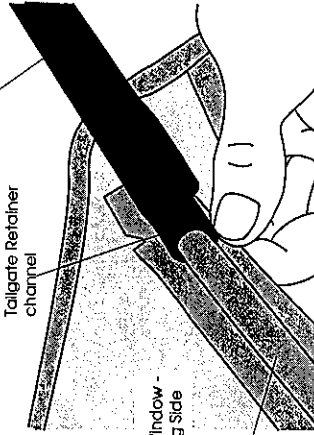

Step Twelve

Remove the Rear Window from the box and lay it flat with the backing side up. Locate the Tailgate Bar set aside in Step One. The bar has a "C" shaped channel, when viewed from the end. Orient the bar with the round seal down and slide the "C" channel on the retainer onto the tubed strip sewn to the backing side of the Rear Window.

Step Thirteen

Insert the Tailgate Bar into the mounts on each side of the tailgate opening with the vinyl side of the Rear Window toward the outside of the vehicle.

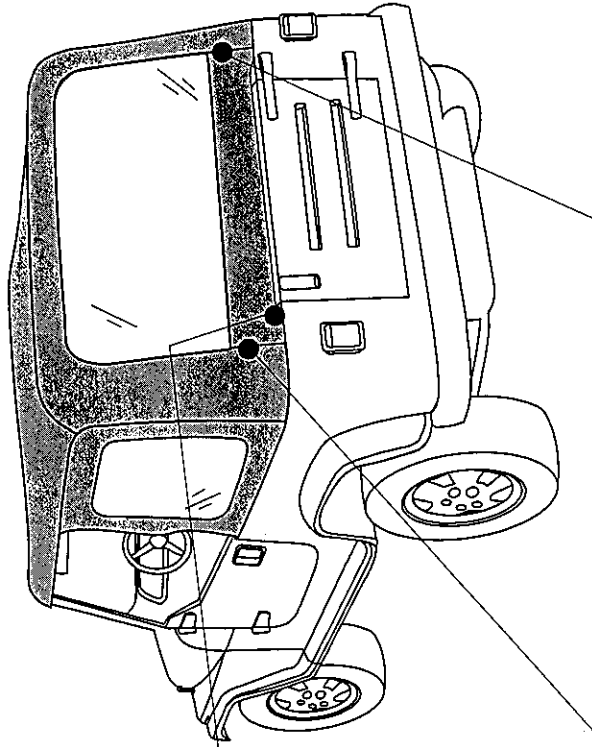
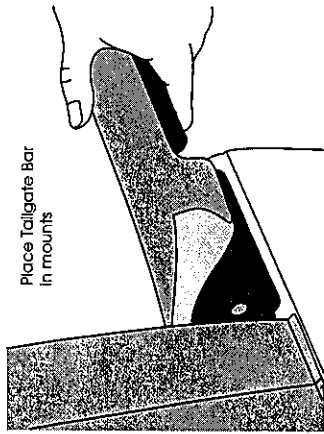

Step Fourteen

To start the zipper, pull the two sliders as far down as possible on the driver's side of the window in order to catch the sliders to the pin.

Once the zipper is caught, start the top slider 1/2". Then hold up the top of the window with one hand and close the zipper with the other. The zipper is sandwiched between layers of fabric in the corners so be careful not to catch extra fabric in the zipper. Close the zipper.

Make sure that the Tailgate Bar is centered and is securely in the mounts. Then tuck the flaps on the Rear Window under the top fabric.

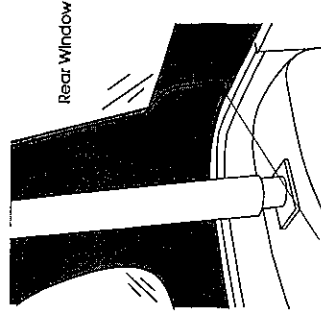
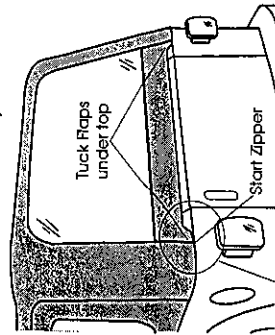

Pull flap over to cover zipper and tuck in

View from inside top

Step Fifteen

Inside the top locate the flaps sewn to the top on each side of the rear window opening. Pull the flaps over to cover the zipper and tuck them in.

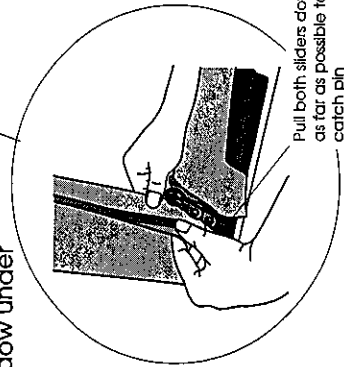

Note: For the best results and to minimize scratches on the windows, remove all jewelry before installing the door covers.

Note: This door cover is designed to fit very tight on the door frame. We recommend using a shoe horn to help work the corners of the cover over the frame without tearing the fabric.

Installing the New Door Covers

WARNING

Do not pull on the weatherstrip to assist in getting the door cover on the door frame. This will tear the weatherstrip and the door will not seal properly.

Step Sixteen

Remove the fabric upper doors from the vehicle. Use a razor knife to cut the stitches on the old door covers and take them off of the door frames.

Step Seventeen

Unzip the windows and separate the hook and loop fasteners on the door covers. Lay the door cover on a flat smooth surface with the outside facing down.

Start by working the lower rear corner of the door frame into the pocket in the lower rear corner of the cover. Then work the lower front corner of the frame into the cover. Work the top front corner of the frame into the corner of the cover, between the hook and loop flaps (not between the zipper and the flap). Finally, use the tab sewn into the cover to work the last corner of the frame into the corner of the door cover, again between the hook and loop flaps.

Make sure that the top edge of the door cover is straight along the top of the door frame. Work around the door fastening the hook and loop strips tightly around the door frame. Once the door cover is on the frame, the tab in the top rear corner of the cover may be cut off with a pair of scissors if desired.

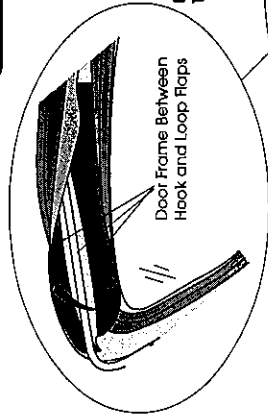

Detail of Hook and Loop - Top of Door

3. Install Upper Front Corner

4. Use tab to install Upper Rear Corner

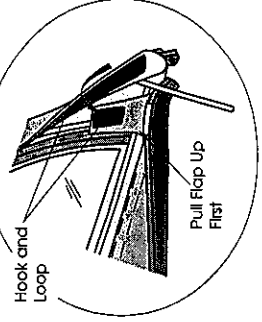
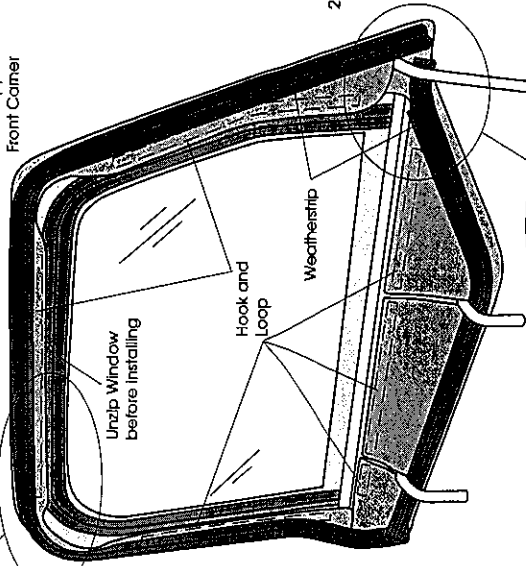

Detail of Hook and Loop - Lower Front Corner

Step Eighteen

Reinstall the upper doors. Insert the pins into the grommets in the lower door.

Folding the Top Down

Step One

Remove the Quarter Panels and the Rear Curtain and store them carefully.

Collapse bows and fold toward rear

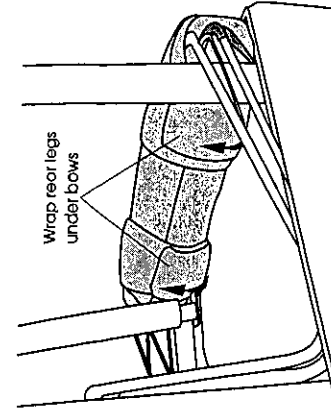
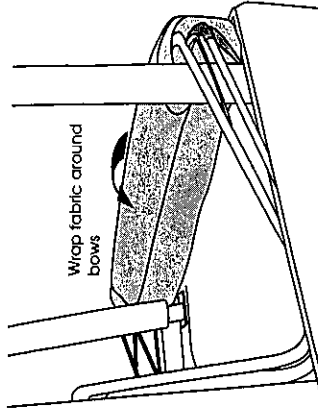
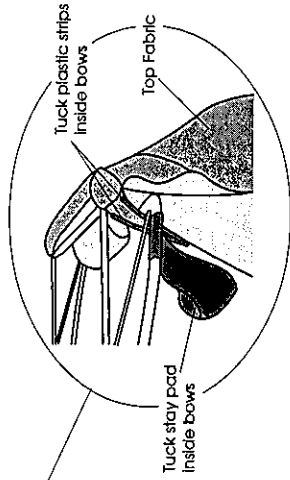
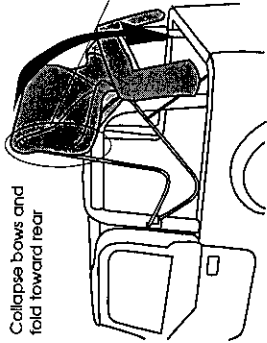

Step Two

Release the front of the top from the windshield. Raise the front of the deck and collapse the rear bows, tucking the two plastic strips above the door openings and the stay pad on the rear bow inside of the bows. Wrap the fabric around the bows, then tuck the rear legs of the top under the bows.

Care and Maintenance of your New Top

Your top is made of the finest materials available. To keep it looking new and for the maximum possible wear, it will need periodic cleaning and maintenance.

Washing: The fabric should be washed often using soap, warm water and a soft bristle brush. Rinse with clear water to remove all traces of soap.

Zippers: Keeping the zipper cleaned and lubricated

with a silicone lubricant will help prevent damage and keep the

zippers in a smooth working condition. If a zipper opens behind the slider, the slider

may have been spread apart. This

problem can usually be repaired by using an ordinary pair of pliers to bring the sides back into parallel. Return slider to the end of the zipper in the normal Open position.

Squeeze lightly at first and test the zipper.

If the zipper continues to remain open squeeze more firmly with the pliers and try the zipper again. Repeat this procedure until the zipper operates correctly.



Normal Slider -
Jaws Parallel



Damaged Slider -
Jaws Spread Apart
(sometimes broken)

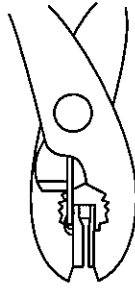

Water: In the event of seeping through the seams, 3M Scotchgard® may be applied on the inside of the seams to stop the seepage. Rips in the fabric may be repaired with Bondex® iron on patches. Iron the patches to the inside of the top, carefully following the Bondex® instructions.

Snaps: Keep snaps cleaned and lubricated with silicone to help prevent snaps from sticking to the studs. If a snap does become stuck to a stud, use a screwdriver and GENTLY pry apart to prevent permanent damage to the snap or the top fabric.

Windows: Keep windows clean to avoid scratching. DO NOT use a brush on the windows! Wash with a water-soaked cloth or sponge and a mild dishwashing detergent. NEVER WIPE THE WINDOWS WHEN THEY ARE DRY. Be careful when cleaning snow or frost from the vinyl windows since they are easily scratched and may crack at low temperatures. DO NOT roll the sides or rear window in cold weather. The windows become stiff and will crack. Cold cracks are not covered under warranty.

LIMITED WARRANTY

We warrant our product to be free from defects in material and workmanship, for the terms specified below, provided there has been normal use and proper maintenance. This warranty applies to the original purchaser only. All remedies under this warranty are limited to the repair or replacement of any item or items found by the factory to be defective within the time period specified.

If you have a warranty claim, first you must call our factory at the number below for instructions. You must retain proof of purchase and submit a copy with any items returned for warranty work. Upon completion of warranty work, if any, we will return the repaired or replaced item or items to you freight prepaid. Damage to our products caused by accidents, fire, vandalism, negligence, misinstallation, misuse, Acts of God, or by defective parts not manufactured by us, is not covered under this warranty.

THE WARRANTY TIME PERIOD IS AS FOLLOWS: ALL "SOFT GOODS" MANUFACTURED BY OUR COMPANY (USING PRIMARILY VINYL, PLASTICS, AND/OR FOAM): TWO YEAR FROM DATE OF PURCHASE.

ANY IMPLIED WARRANTIES OF MERCHANTABILITY AND/OR FITNESS FOR A PARTICULAR PURPOSE CREATED HEREBY ARE LIMITED IN DURATION TO THE SAME DURATION AND SCOPE AS THE EXPRESS WRITTEN WARRANTY. OUR COMPANY SHALL NOT BE LIABLE FOR ANY INCIDENTAL OR CONSEQUENTIAL DAMAGE.

Some states do not allow limitations on how long an implied warranty lasts, or the exclusion or limitation of incidental or consequential damages, so the above limitations or exclusions may not apply to you.

This warranty gives you specific legal rights, and you may also have other rights which vary from state to state.

For further information please contact:

Bestop Inc.
Customer Service
(800)845-3567
(303)465-1755