



3651 N. Hwy 89
Chino Valley, AZ 86323
(928) 636-7080 • www.p-a-g.net

**2011-2013 CHEVY/GMC
2500HD/3500HD
DURAMAX DIESEL PICKUP
(New Body Style) 3" BODY LIFT
INSTALLATION INSTRUCTIONS
KIT #10253**

⚠ WARNING
Installation of a Performance Automotive Group body lift kit will change the vehicle's center of gravity and handling characteristics both on and off-road. You must drive the vehicle safely! Extreme care must be taken to prevent vehicle rollover or loss of control, which could result in serious injury or death. Avoid sudden sharp turns or abrupt maneuvers and always make sure all vehicle occupants have their seat belts fastened.

⚠ WARNING
Before you install this kit, read and understand all instructions, warnings, cautions, and notes in this instruction sheet and in the vehicle owner's manual.

⚠ CAUTION
Proper installation of this kit requires knowledge of the factory recommended procedures for removal and installation of original equipment components. We recommend that the factory shop manual and any special tools needed to service your vehicle be on hand during the installation. Installation of this kit without proper knowledge of the factory recommended procedures may affect the performance of these components and the safety of the vehicle. We strongly recommend that a certified mechanic familiar with the installation of similar components install this kit.

⚠ WARNING
DO NOT combine suspension, body, or other lift devices. Use of vehicle with combined lifts may result in unsafe and/or unexpected handling characteristics.

⚠ WARNING
This kit should only be installed on a vehicle that is in good working condition. Before you install the kit, thoroughly inspect the vehicle for corrosion or deformation of the sheet metal around the factory body mounts. If the vehicle is suspected to have been in a collision or misused, do not install this kit. Off-road use of your vehicle with this kit installed may increase the stress applied to the factory body mounts. We do not recommend that any vehicle with a body lift kit installed be involved in any extreme off-road maneuvers such as jumping. Failure to observe this warning may result in serious personal injury and/or severe damage to your vehicle.

⚠ WARNING
Many states and municipalities have laws restricting bumper heights and vehicle lifts. Consult state and local laws to determine if the changes you intend to make to the vehicle comply with the law.

⚠ WARNING
The installation of larger tires may reduce the effectiveness of the Braking System.

⚠ WARNING
Always wear eye protection when operating power tools.

⚠ WARNING
Before you install this kit, block the vehicle tires to prevent the vehicle from rolling.

⚠ WARNING
Accidental deployment of the air bag can result in serious personal injury or death. To avoid accidental deployment during installation of the kit, the Supplemental Restraint System (SRS, or airbag) must remain deactivated. Do not allow anyone near the airbag during installation. Refer to the factory service manual or owner's manual for the recommended procedure to disable the SRS. After you install the kit, reactivate the SRS before driving the vehicle.

⚠ NOTE
Performance Automotive Group recommends using the Loctite® supplied in the kit on the threads of all kit nuts and bolts unless specified otherwise in these instructions.

Before Starting Installation

⚠ NOTE

Kit parts are prefaced by the word **kit** and appear in **bold print**.

1. Carefully read all warnings and instructions completely before beginning.
2. Verify all parts have been received in this kit by checking the parts list at the end of this document.

⚠ NOTE

If parts are missing from kit, please be prepared to provide the following information:

1. **Name** of purchase location
 2. **Bar Code** on side of box
 3. **Date** above bar code
 4. **Date** inside box cover
 5. **Inspector #** from inside box cover
3. **Only install this kit on the vehicle for which it is specified.** If anytime during the installation you encounter something different from what is outlined in the instructions, call technical support at (928) 636-7080.
4. Special tools needed:
- a. Die grinder or similar tool capable of cutting metal.
5. Park the vehicle on a clean, dry, flat, level surface and block the tires so the vehicle cannot roll in either direction.

A. Engine compartment

1. Battery cables
 - a. Disconnect battery cables from both batteries. Disconnect two negative cables first, then two positive cables.

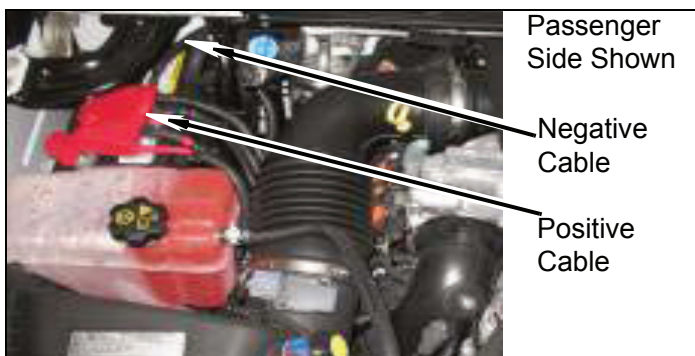

2. Airbag fuse
 - a. Remove cover and airbag fuse "SIR" from fuse panel. Fuse locations may vary. Check fuse chart on back of cover.



B. Measurements

1. Measure distance between the front bumper and front fenders. Record measurement.
Driver Side _____ Passenger Side _____
2. Measure distance between rear bumper and bed.
Driver Side _____ Passenger Side _____
3. Measure and record distance between cab and bed both sides.
Driver Side _____ Passenger Side _____

Prepare to install kit.

A. Front of vehicle

1. Grille
 - a. Remove cover from core support with seven push pins.

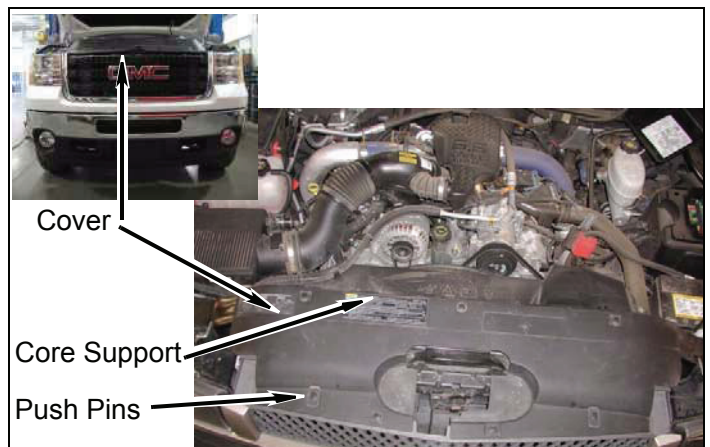

- b. Remove four bolts, six clips, and grille from core support. Some GMC models may have extra clips.

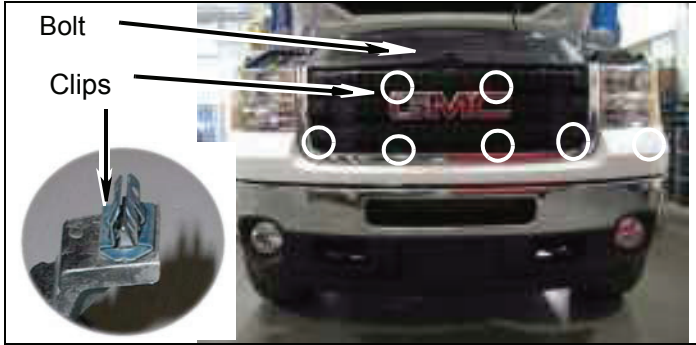

2. Front bumper

- a. If equipped, remove two connectors from two fog lamps.
- b. Remove six bolts and two front outer bumper braces from front bumper and frame.

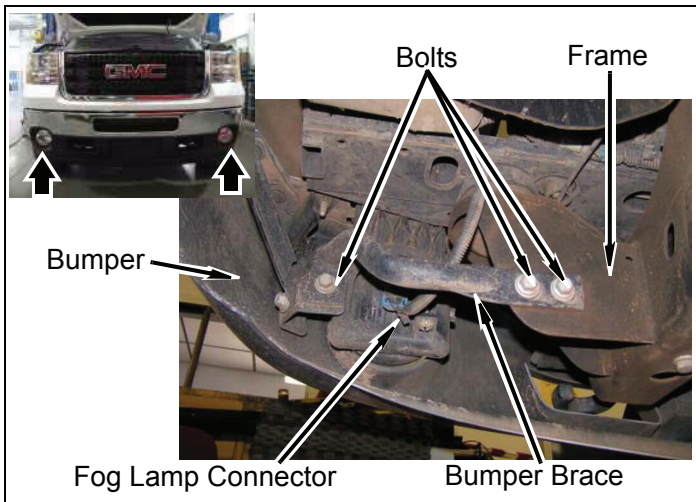

- c. Remove two bolts from each fender side and remove bumper face from core support and fenders.

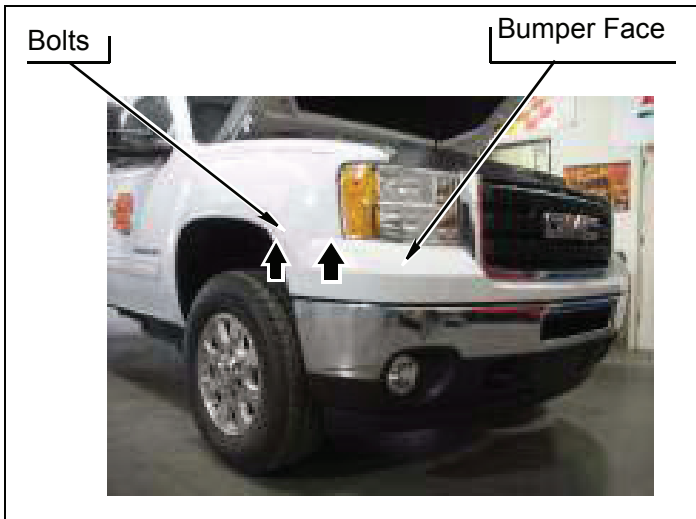

- d. Remove four nuts, two double-bolt fasteners and two frame brackets from two frame horns.

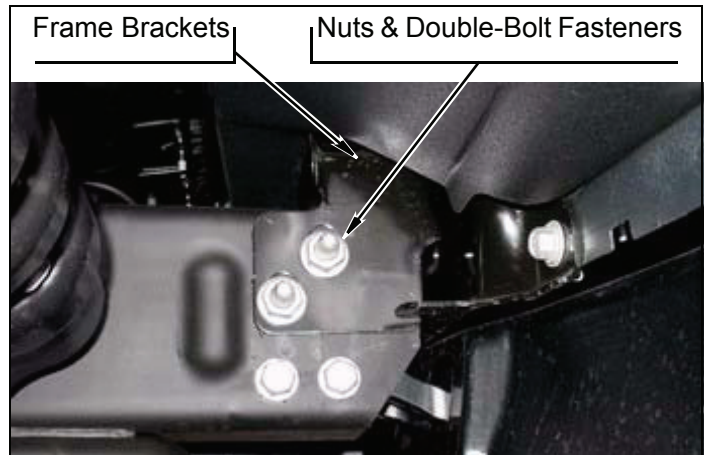

- e. Remove four bolts, two nuts and two tow hooks from frame horns.

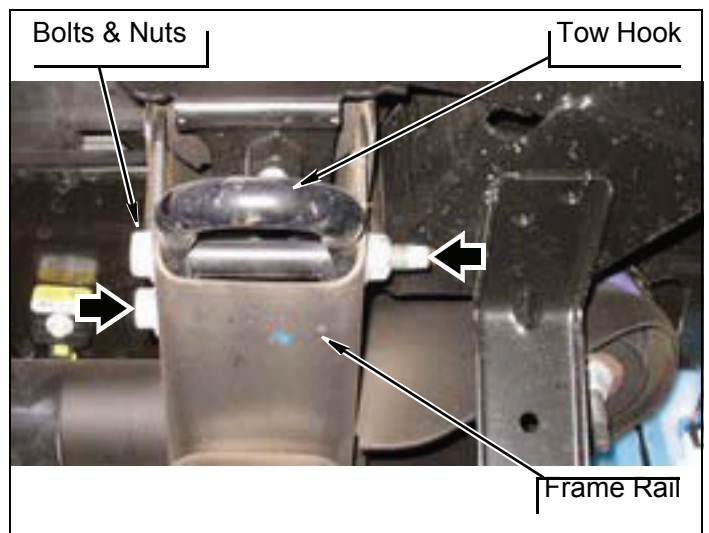

3. Plastic cover and air flap

- a. Remove five bolts, and plastic cover from frame and core support.

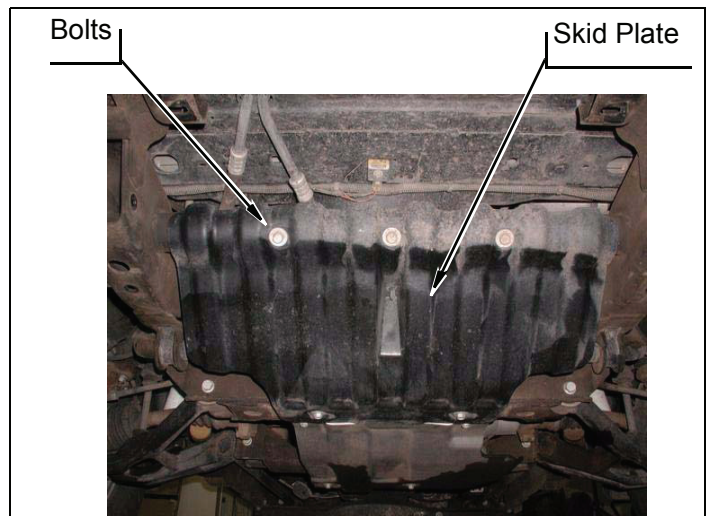

b. Remove plastic cover from push clip, lower radiator hose and vehicle.

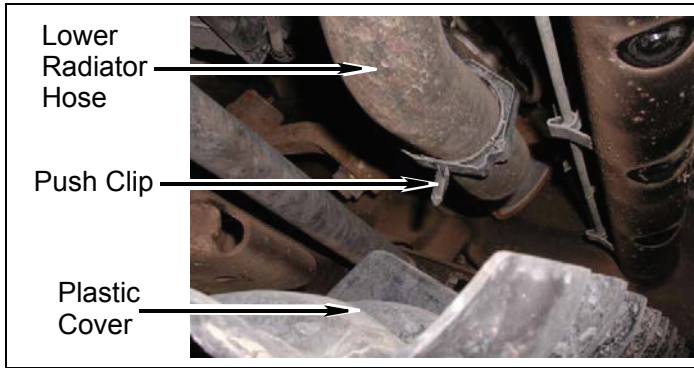

c. If equipped, remove clip and harness from air flap.

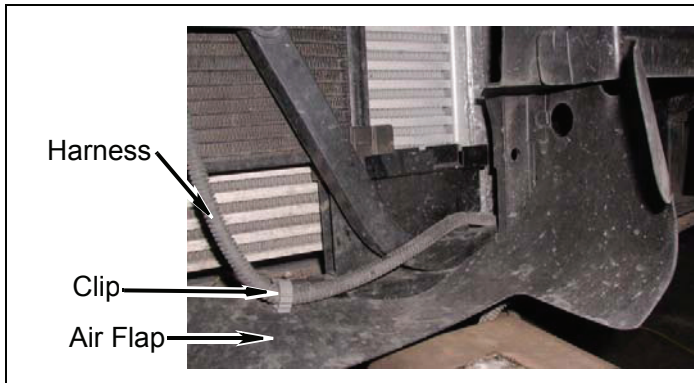

d. Remove two clips, three push pins, and air flap from core support.

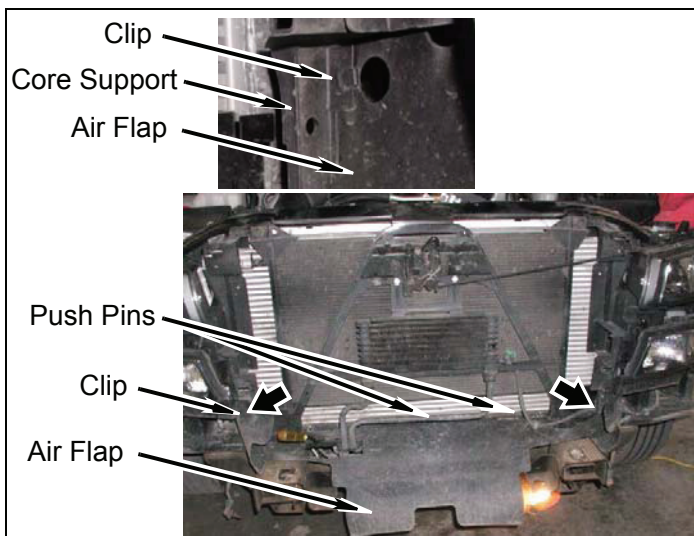

e. Remove front bumper from frame horns.

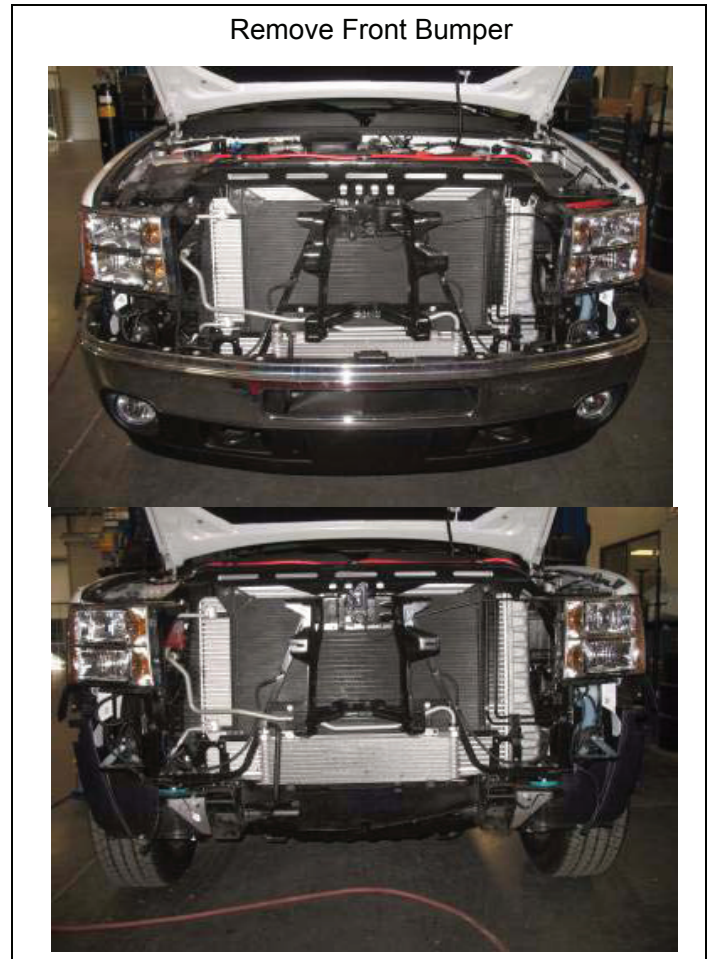

4. Transmission cooler

NOTE
Tie transmission cooler to core support so that it hangs free, and not binding hoses.

- a. Remove two bolts and transmission cooler from core support.
- b. Remove two gromits from transmission cooler.

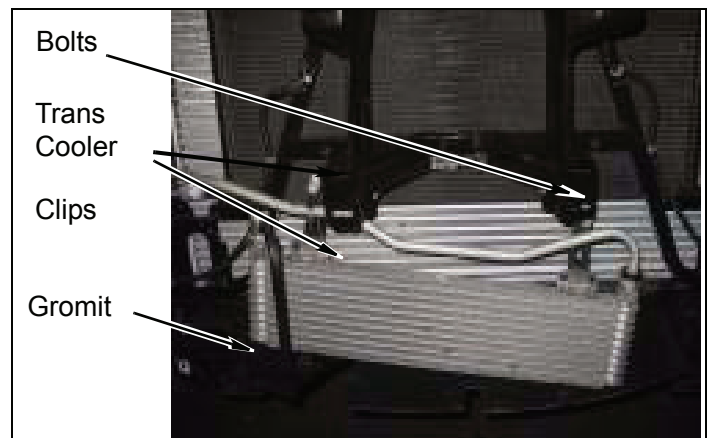

B. Engine Compartment

1. Air intake

- a. Loosen clamp from air baffle assembly. Remove wire harness clip from sensor.

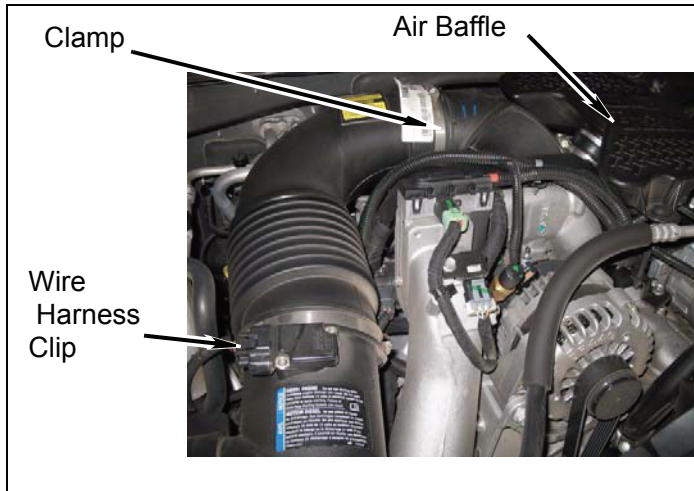

- b. Rotate air intake assembly away from engine and towards fender while pulling the air box up and out of rubber grommets on fender.

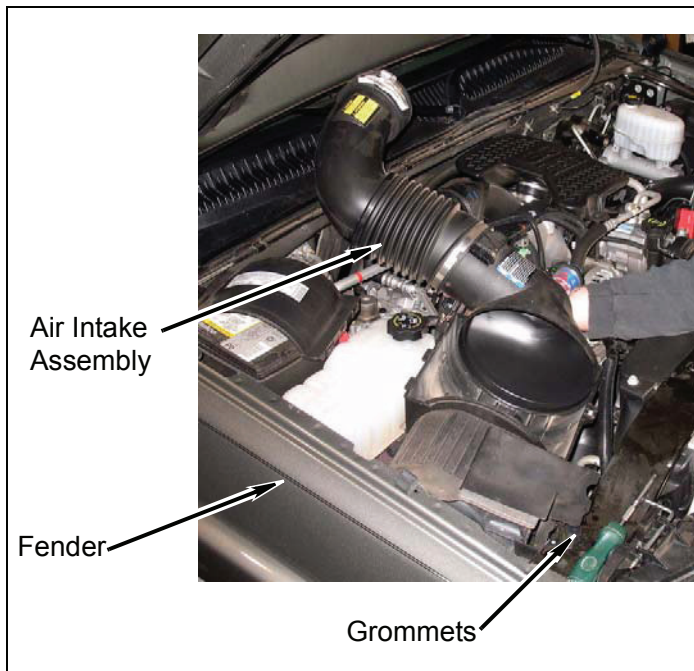

- c. Remove A/C hose from clip on upper fan shroud.

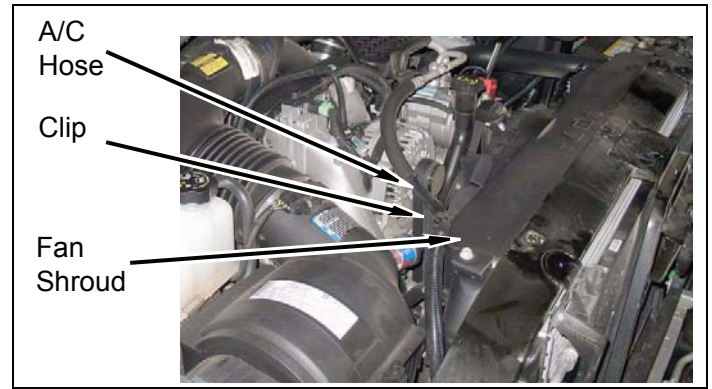

2. Fan shroud

- a. Remove single push clip and computer from upper fan shroud.

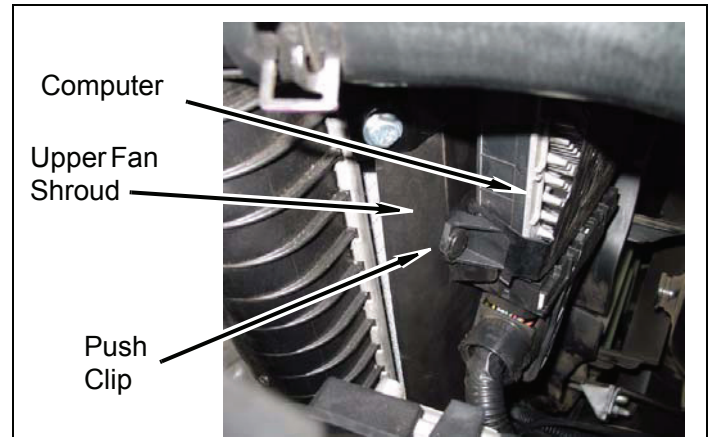

CAUTION

Do not disconnect wiring harnesses from computer module.

- b. Lift up and back to remove computer module from fan shroud. Rest assembly on power steering belt/pump.

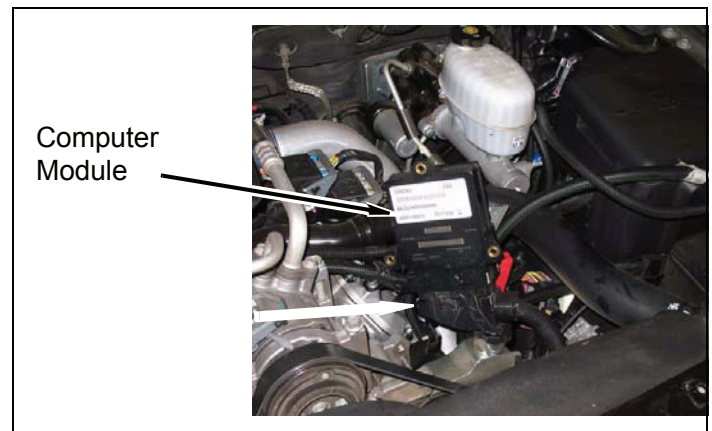

- c. Remove four pop-ups and upper fan shroud from vehicle.

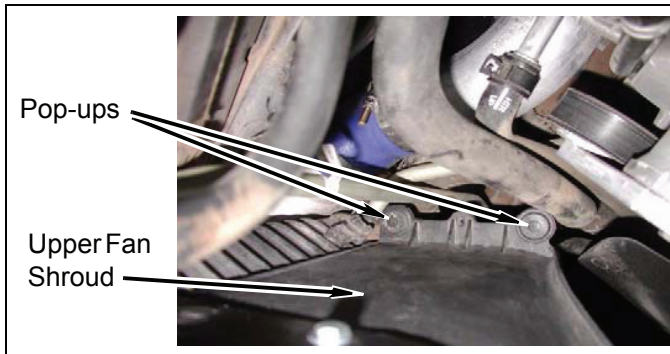

- d. Remove computer wiring harness from harness push clip and lower fan shroud.

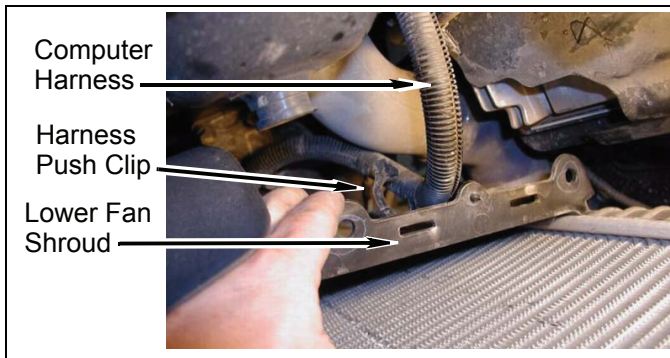

- e. Lift lower fan shroud from radiator clips on side of radiator body.

NOTE
The following step, requires two people to position lower fan shroud under radiator.

- f. Remove two bolts, intercooler, and radiator from core support. Lift intercooler and radiator. Do not remove from vehicle. Carefully push lower fan shroud down under radiator and core support.

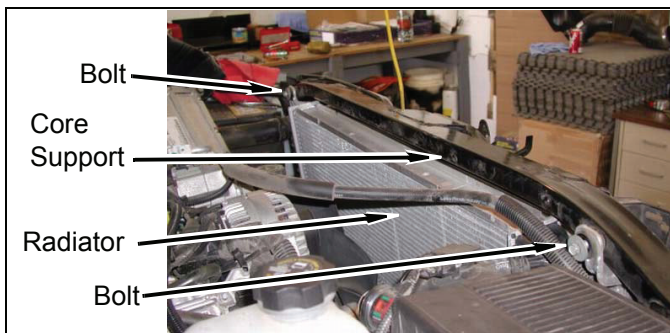

- g. Lower intercooler and radiator and install on core support with two bolts.

3. Intercooler piping passenger side

- a. Remove wire clip from upper intercooler pipe at engine intake manifold. Twist hose clamp ring at upper end of intercooler hose to disconnect hose from throttle body.

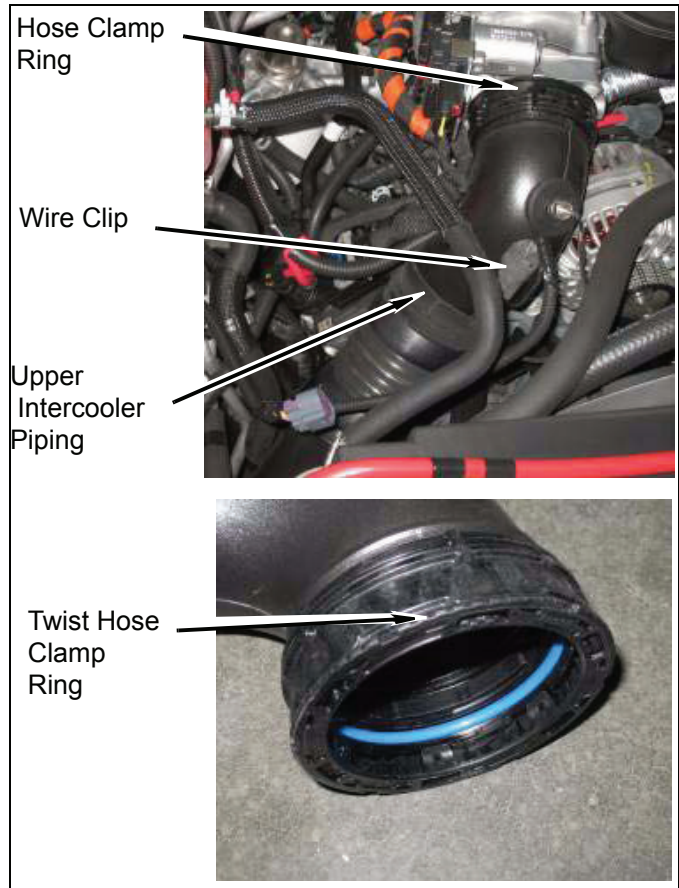

- b. Remove Lower intercooler pipe and hose from vehicle by twisting ring clip.

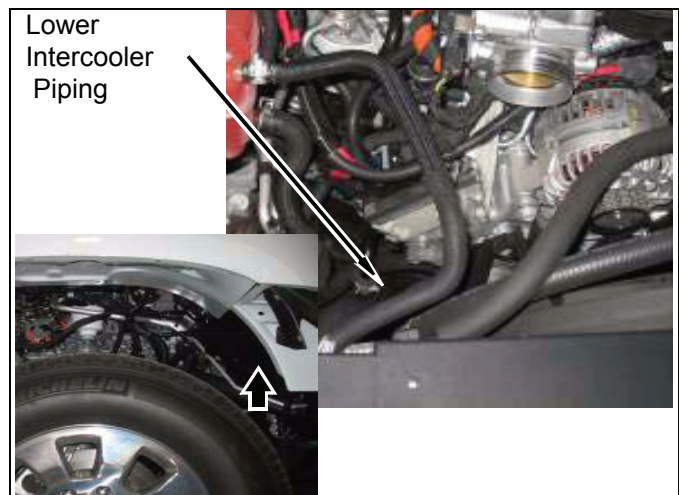

- c. Remove clip and harness from engine mounted bracket.

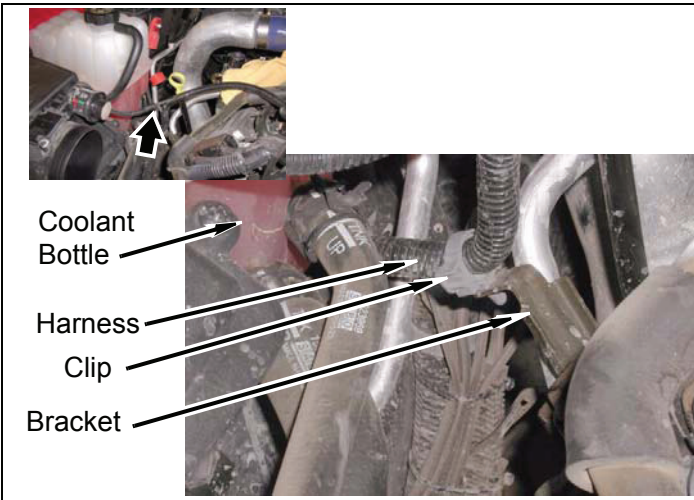

- b. Remove bolt and nut from upper and lower steering shaft.

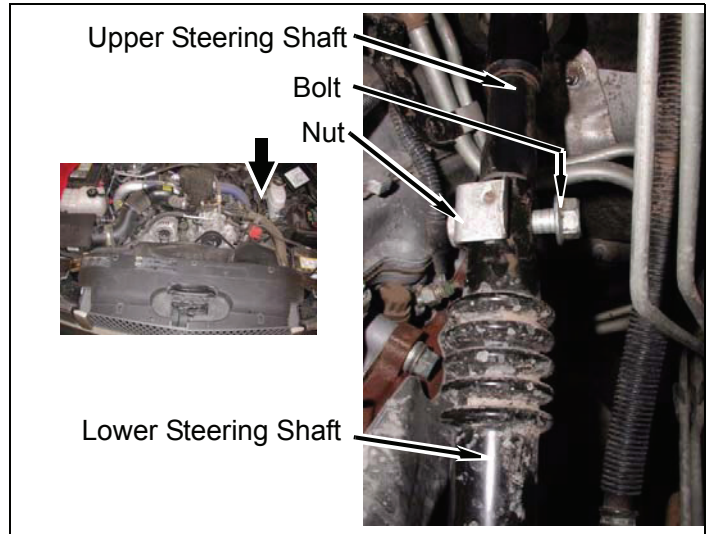

4. Intercooler piping drivers side

- a. Loosen clamp, silicone hose, and intercooler piping from intercooler. Do not remove.

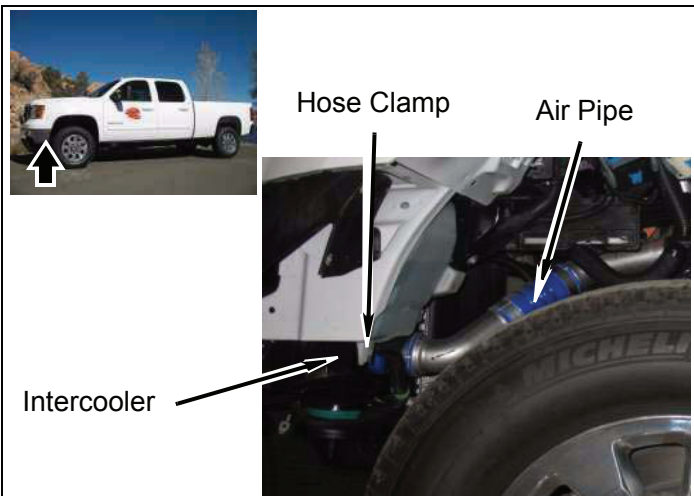

- c. Slide upper steering shaft up to separate from lower steering shaft.

6. Wiring harnesses and ground strap

- a. Remove nut and ground strap from stud on fire wall.

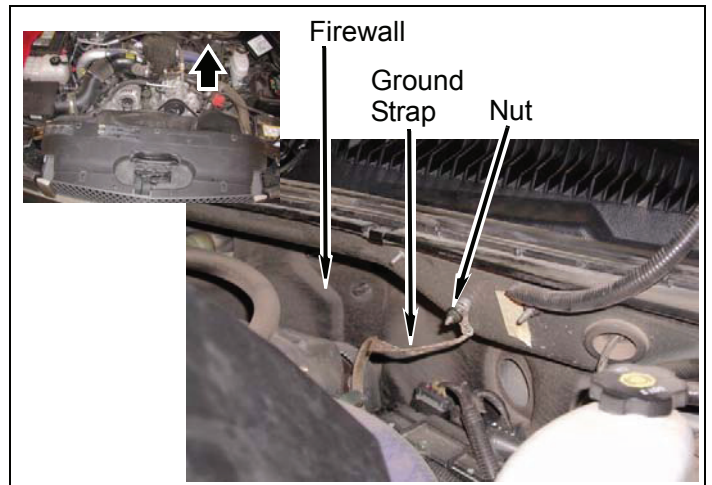

NOTE
 Ensure steering shaft does not turn independently of the steering gearbox. This could cause the air bag system to malfunction, resulting in serious personal injury or damage to the equipment.

5. Steering shaft

- a. Straighten steering wheel and strap the wheel so it will not turn.

b. Remove harness from clip and bracket.

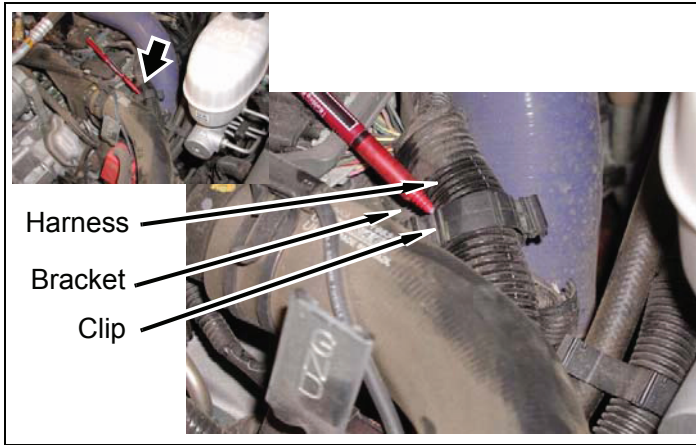

NOTE
Driver side inner fender well was removed for clarity and ease of access.

b. Remove clip and harness from frame and shock tower driver side.

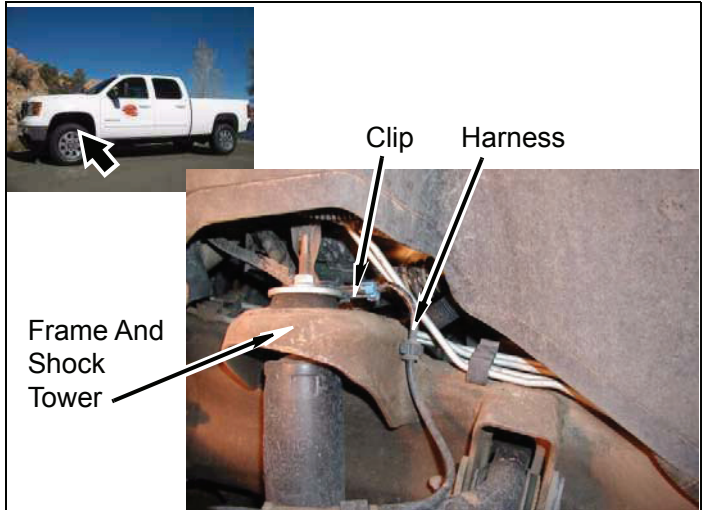

c. Remove two clips and harness from cover and inner fender.

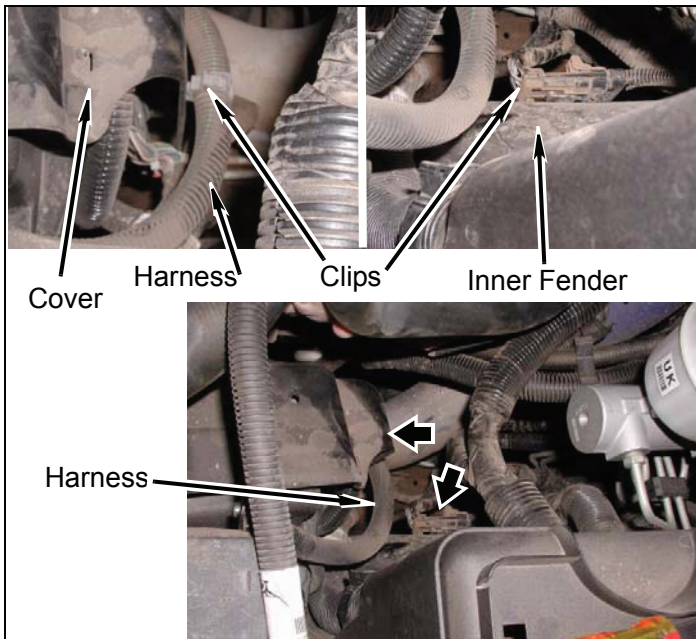

c. Carefully bend power steering pressure line at power steering pump by pulling toward fire wall as shown. Do not allow line to kink.

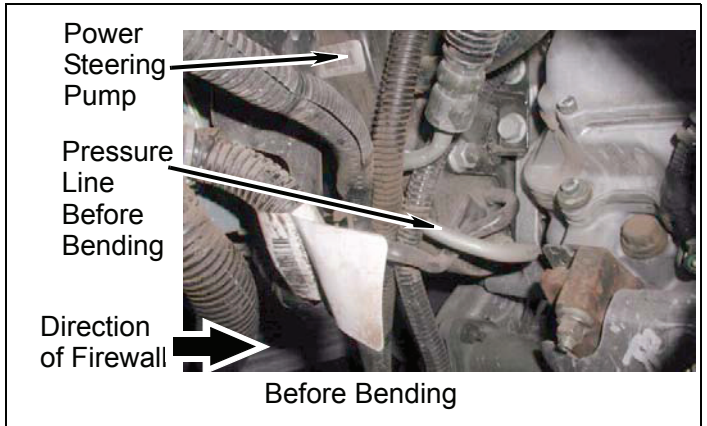

7. Wiring harnesses and power steering drivers side

a. Remove bolt and two ground wires from frame.

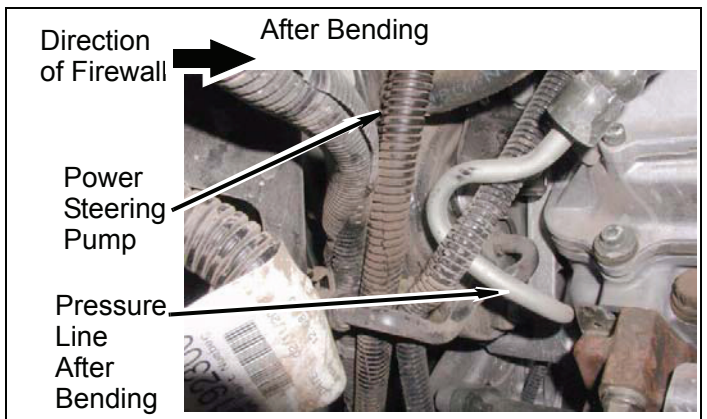
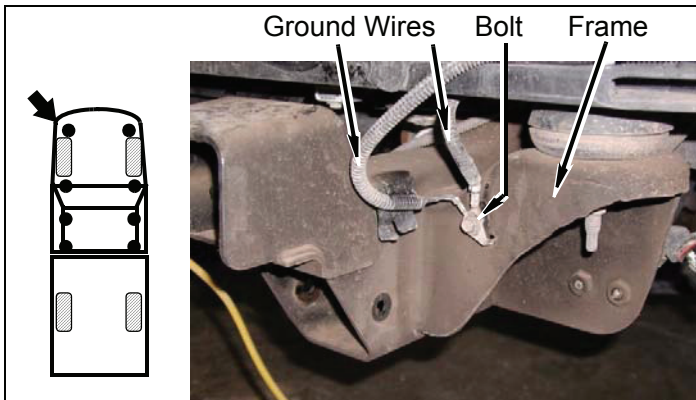

- d. Carefully bend power assist pressure line up toward hood, to clear accumulator on brake hydro boost.

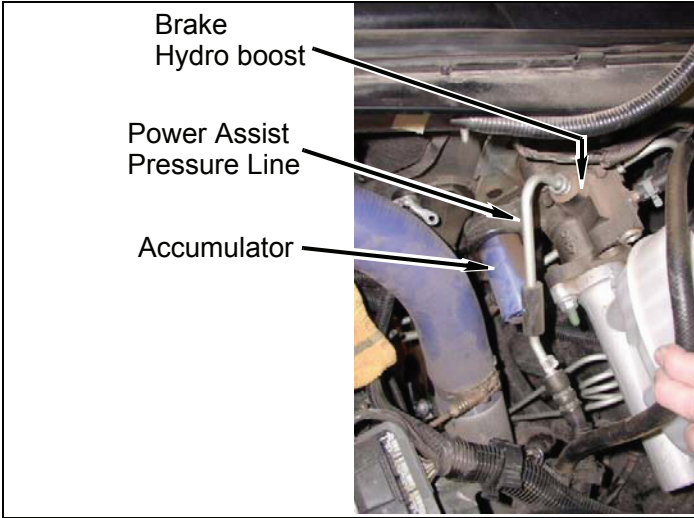

- e. Loosen power assist pressure line fitting at brake droopiest housing and position power assist pressure line along side of accumulator as shown.

- f. Tighten power assist pressure line fitting at brake droopiest housing.

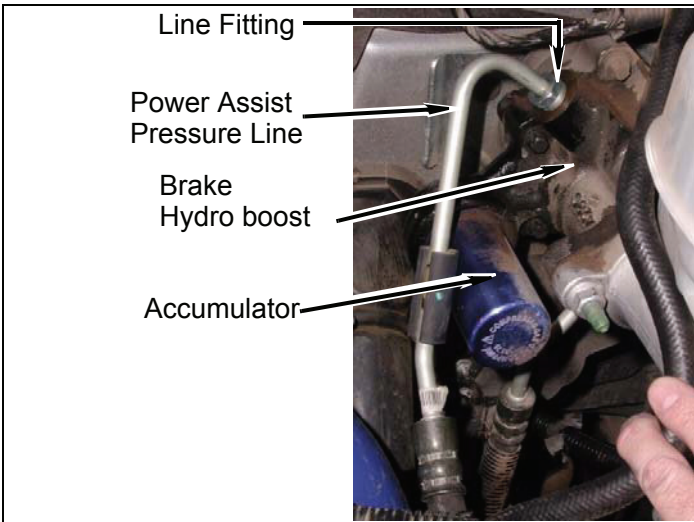

- g. Remove bolt, clamp, and power assist pressure line from frame.

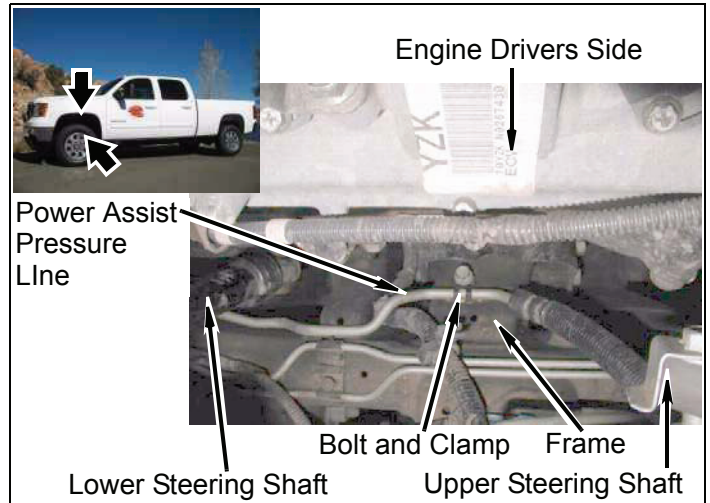

- h. Remove two brake lines from two sets of clips driver side frame.

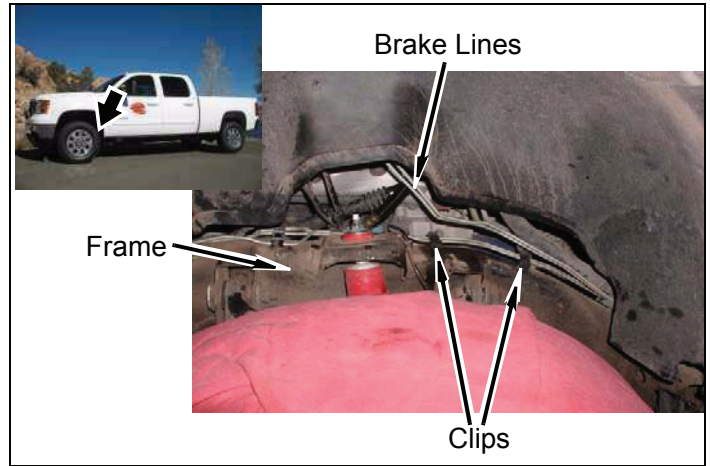

C. Frame

1. Parking brake cable

- a. Remove bolt and ground wires from driver side frame mounting pad.

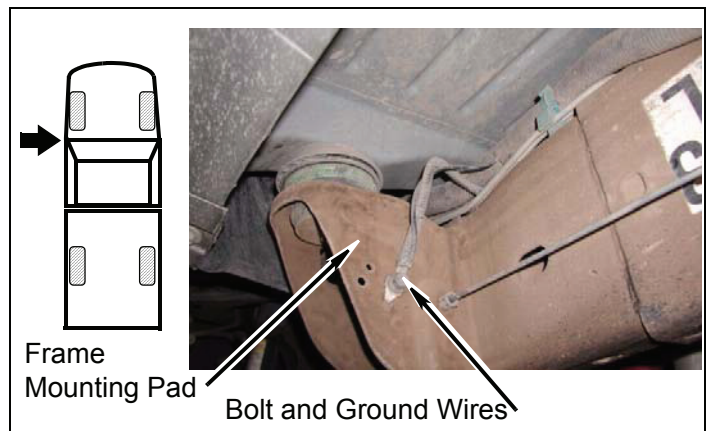

- b. Pull some slack in parking brake cable. Clamp two cables at cable housing where indicated by arrows.

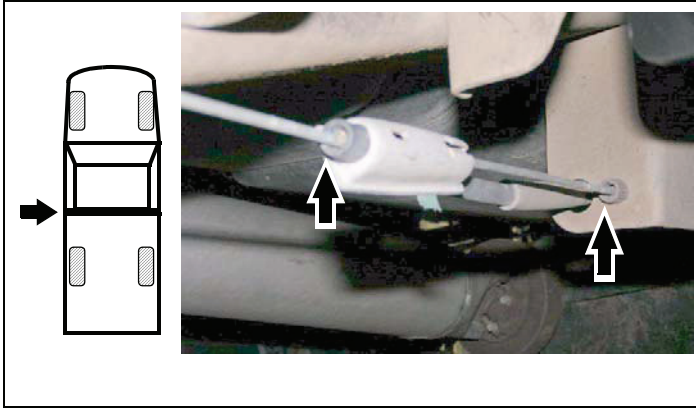

- c. Separate front parking brake cable from rear parking brake cable at cable connector.

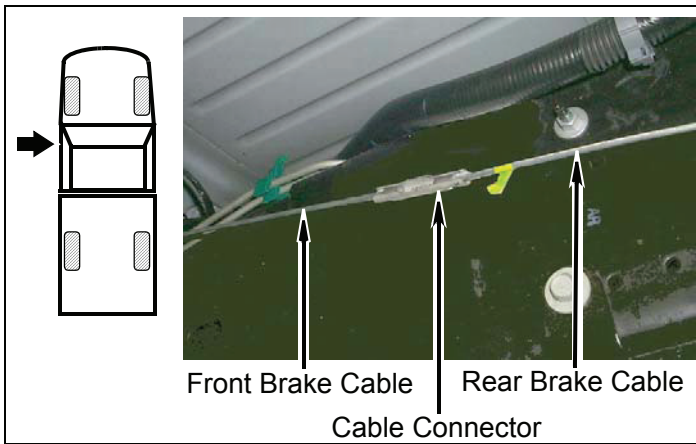

- d. Remove front brake cable and brake cable housing from front frame mounting pad.

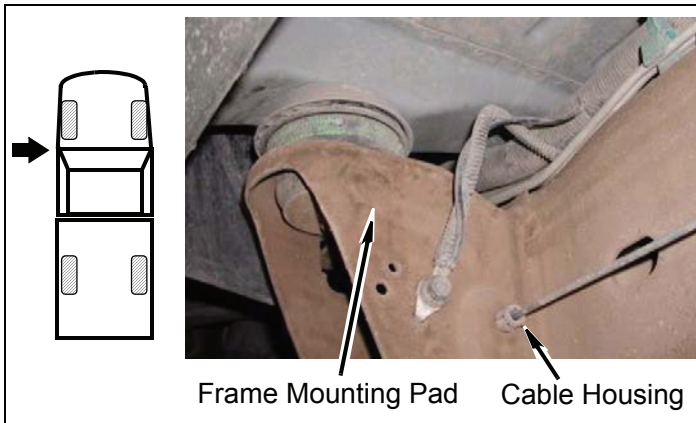

2. **Manual transfer case:** shift linkage

- a. Remove clip containing three metal lines from bracket.

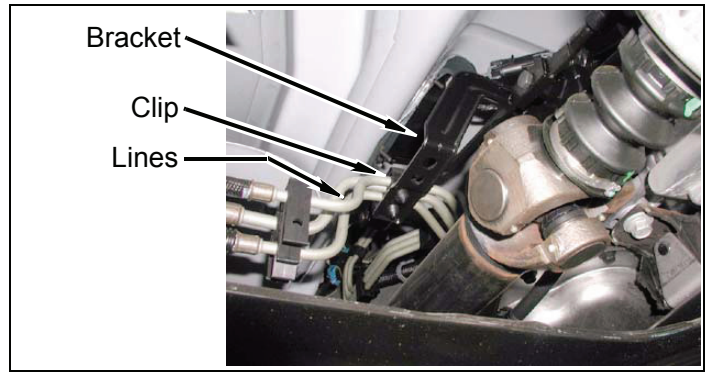

- b. Remove two nuts and bracket from transfer case. Bracket is not reused. Install two nuts and tighten.

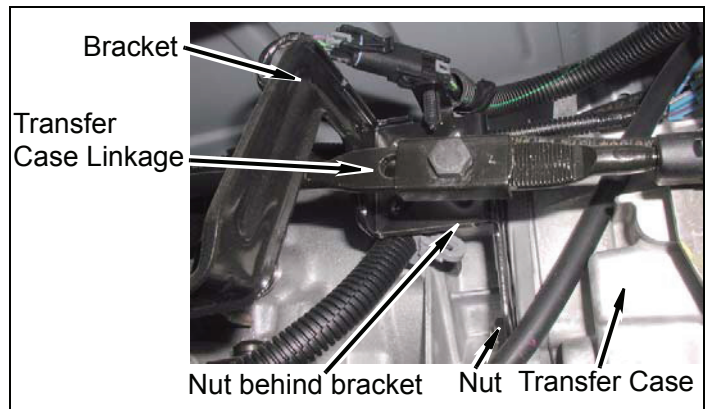

- c. Remove two clips and transfer case linkage from transfer case and pivot.

3. **Single cab only:** Safety cables

- a. If applicable, remove two bolts and safety cables from two rear frame mounting pads.

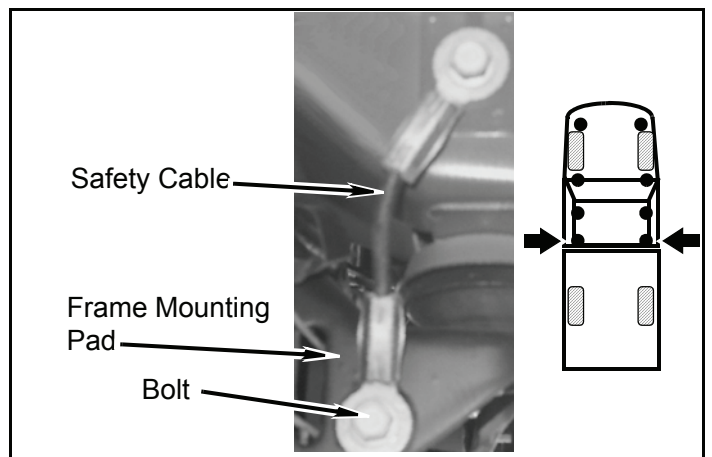

⚠WARNING

Use extreme caution when working near fuel lines and fuel tank. Clean up spilled fuel immediately. Any spark could cause an explosion or fire resulting in serious personal injury and property damage.

D. Rear of vehicle

1. Fuel filler

- a. Remove fuel cap, three bolts, and fuel filler from bed.

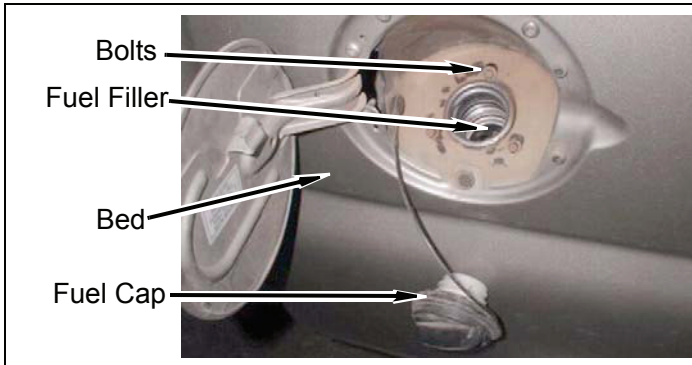

2. Rear bumper

⚠NOTE

Removal of spare tire might be helpful, but not mandatory (refer to the Owner's Manual).

- a. Unplug rear bumper light wiring harness from frame connector.

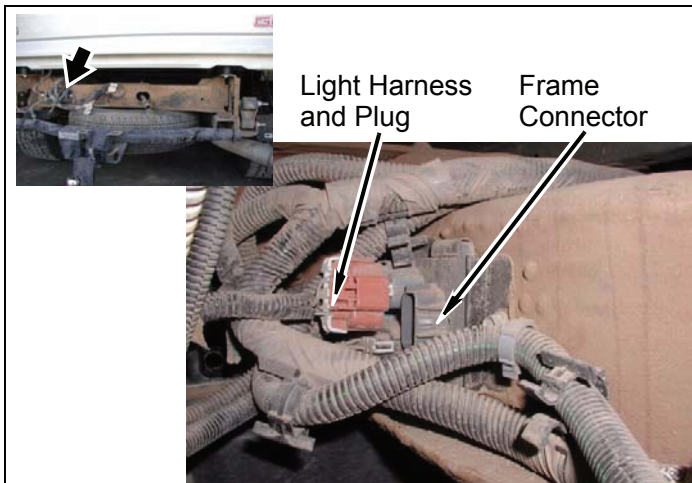

- b. Remove four nuts, two double-bolt fasteners, four bolts and bumper from frame rails.

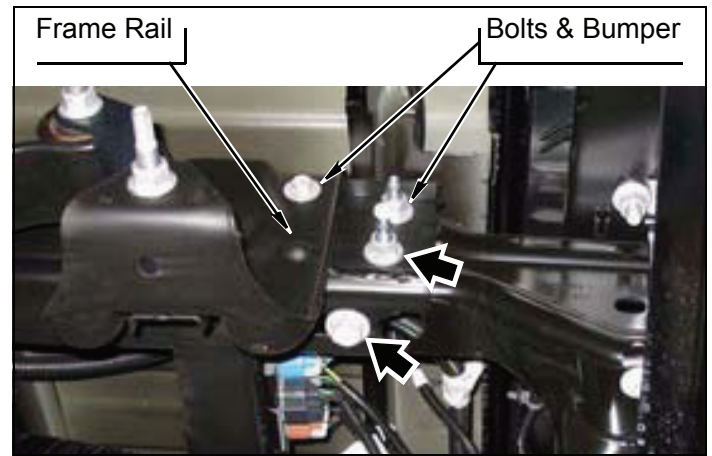

c.

- d. Remove two bolts and bumper from hitch and vehicle.



Install the kit

A. Cab

1. Prepare to lift cab from frame

⚠WARNING

Failure to replace the OEM body mounting hardware (except mounting bolts in the kit) in the stock locations could result in serious personal injury or damage to the vehicle.

⚠NOTE

Ensure stock spacers and body bushings stay on vehicle unless otherwise specified in these instructions. Kit lift **blocks** are installed in addition to the stock spacers and body bushings.

- a. Loosen but do not remove, core support bolt and three cab bolts from drivers side cab.

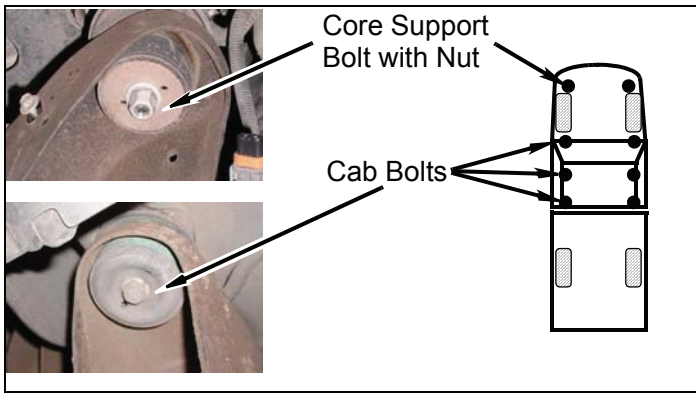

- b. Remove core support bolt, nut, and three cab bolts from passenger side cab.

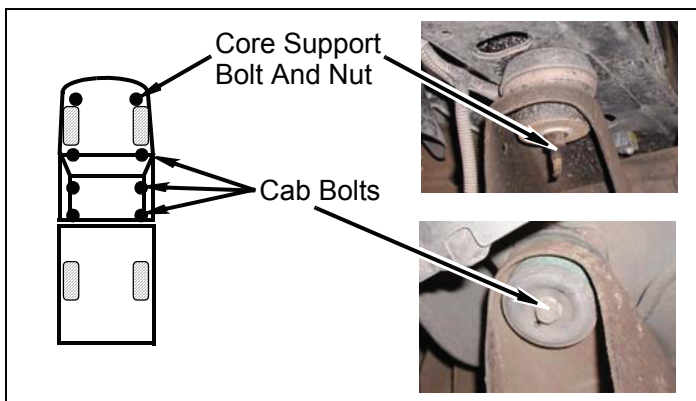

- b. Install a kit **lift block** under core support and on top of upper body bushing, frame, and lower body bushing with a kit **bolt** (12mm-1.75 x 180mm), kit **washer** (1/2" thick), and stock nut. Do not tighten.

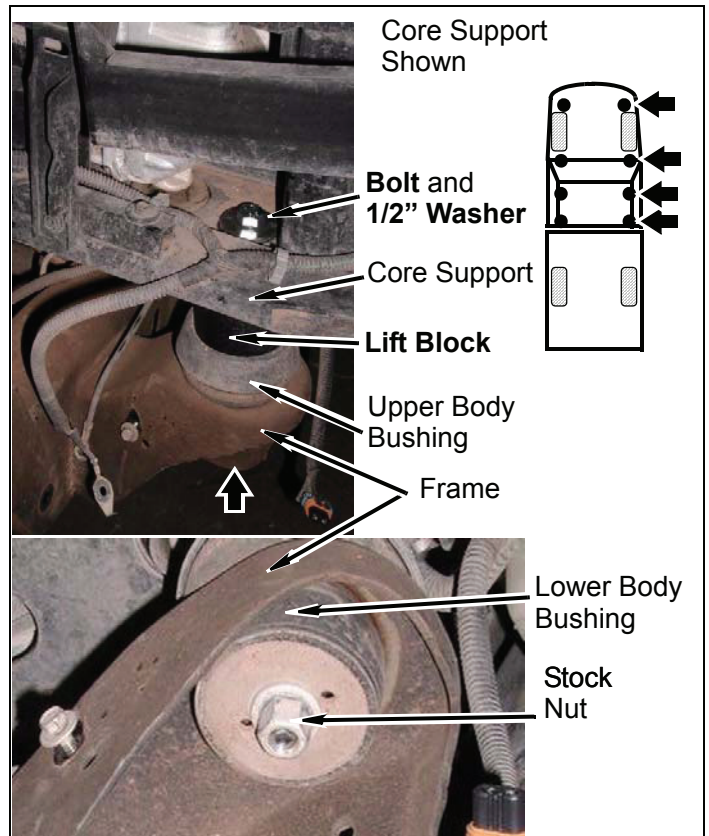

2. Passengers side

- c. Install three kit lift **blocks** (with 5/8" hole) under body and on top of top body bushings, frame, and lower bushings, with three kit **bolts** (14mm-2.0 x 180mm) and kit **washers** (14 mm). Do not tighten.

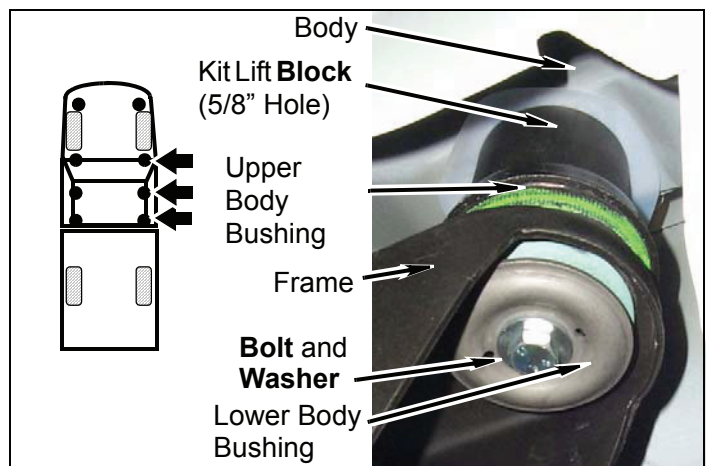

- d. Lower cab onto kit lift **blocks**.

3. Drivers side

CAUTION

Continually check hoses, wires, lines, etc. to be sure that everything is flexing properly and not binding, or damage to the vehicle could result. Be especially careful of the a/c hoses at the fire wall, the belt pulley, and at the core support. Ensure brake lines extend while lifting. Bending the lines to gain ample slack may be necessary. Be extremely careful not to kink the lines.

WARNING

Use extreme caution when lifting body from frame. Ensure lifting device is securely placed. Keep hands out from between frame and body, or serious personal injury could result.

- a. Using a hydraulic jack and a wooden block, slowly lift cab high enough to position a kit lift **block** between core support and body bushing. Position three kit lift **blocks** between cab and remaining body bushings.

- a. Repeat above steps for the cab driver side.
- b. Adjust cab to bed clearance as needed using measurements taken earlier.

4. Finish cab lift **block** installation

- a. Remove eight **bolts** one at a time, place a few drops of kit **Loctite**® on threads, install and tighten to 55ft.lbs.

B. Bed

1. Prepare to lift bed from frame.

- a. Loosen but do not remove four bed bolts driver side (short bed three bolts).

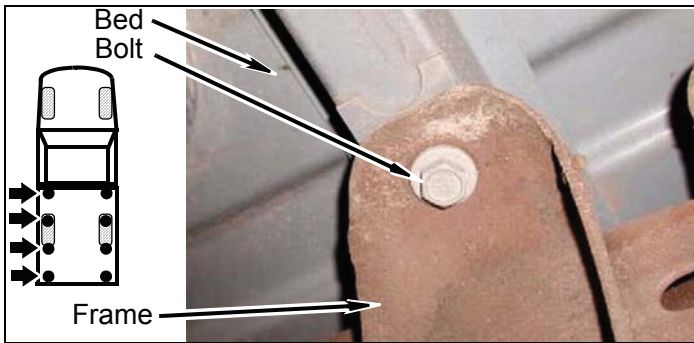

- b. Remove four bed bolts from frame passenger side.

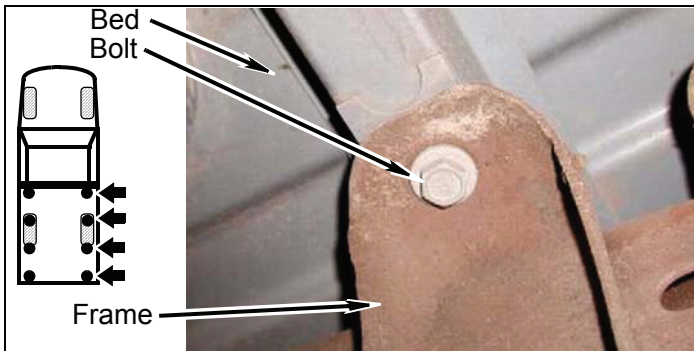

2. Bed passenger side

- a. Using a hydraulic jack and a wooden block, slowly lift the bed high enough to position the kit lift **blocks** between bed and frame mounting pads.

- b. Position four kit lift **blocks** (3" Diameter) between bed and frame as shown.

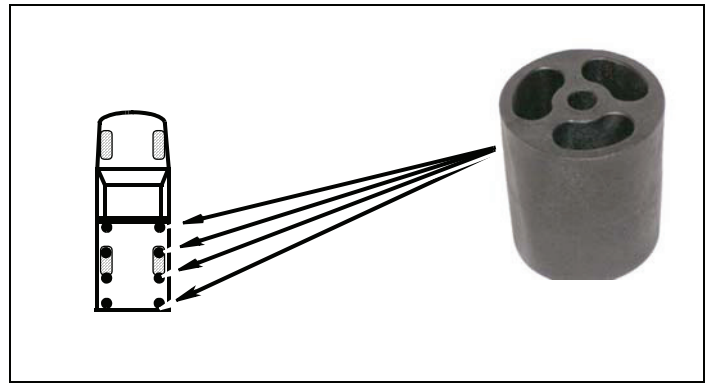

- c. Install kit lift **blocks** on frame and bed with four kit **bolts** (12mm-1.75 x 100mm) and four kit **washers** (7/16" USS). Do not tighten.

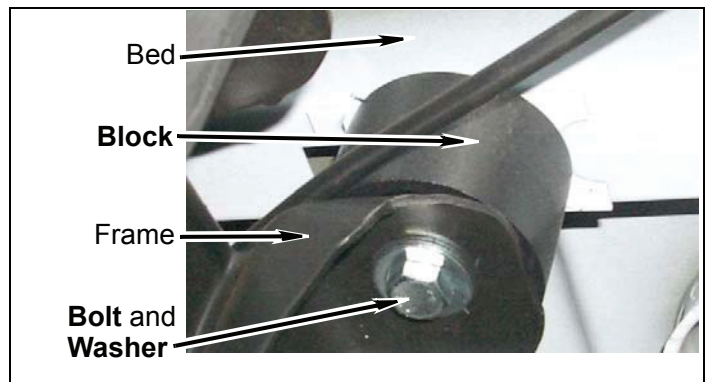

- d. Lower bed onto kit lift **blocks**.

3. Install driver side bed kit lift **blocks**.

- a. Repeat above steps for driver side.

4. Finish the bed kit lift **block** installation.

△NOTE

Place a few drops of Loctite® on threads of all bolts.

- a. Adjust bed to cab clearance as needed using measurements taken earlier.
- b. Remove eight kit **bolts** one at a time, place a few drops of kit Loctite® on threads, install and Tighten to 55ft.lbs.

C. Rear of vehicle

⚠WARNING

The following procedure is intended only to enhance the appearance of the vehicle. The rear bumper will no longer be rated for towing of any kind. Towing with the rear bumper after it has been lifted can result in death, serious personal injury, or damage to the vehicle. Towing after the bumper has been lifted should be accomplished using a rated Class III receiver type hitch.

1. Install rear bumper

- a. Mark, cut, and bend crossmember for spare tire crank tube as shown.

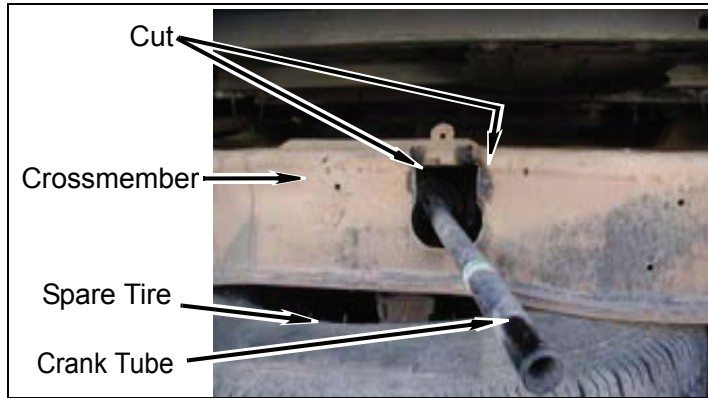

2. Rear bumper

- a. Remove two clips from fascia and bumper.

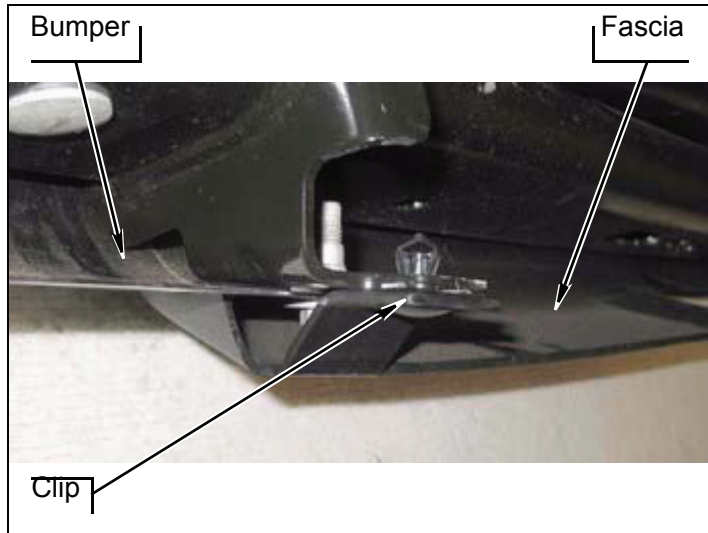

- b. Remove two bolts from bottom of bumper.

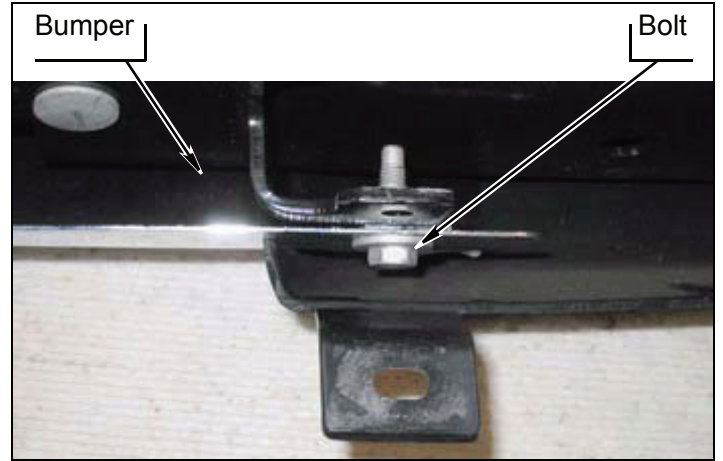

- c. Remove six nuts, two carriage bolts and bumper support from bumper.

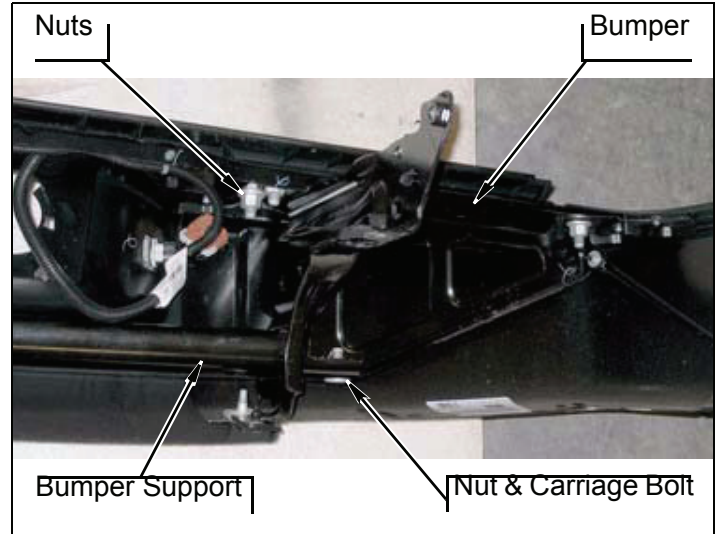

- d. Cut two brackets and remove from bumper support as shown.

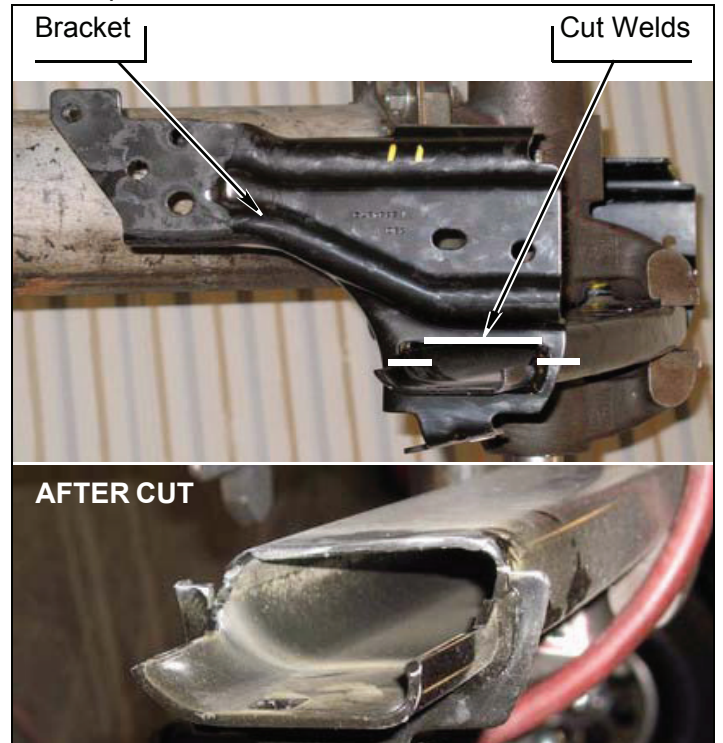

e. Position two **kit brackets** (bumper, rear) onto bumper support against stop.



NOTE
Please note that Frame is boxed in and there is no access to inside of frame rails.

f. Install bumper support and two **kit brackets** (bumper, rear) onto bumper with two O.E. carriage bolts and six nuts. Snug, but **DO NOT TIGHTEN**

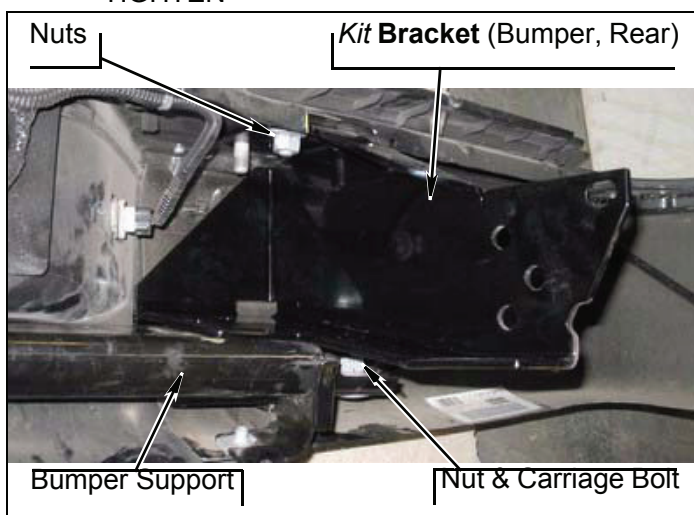

g. Install bumper onto frame rails with all O.E. double-bolt fasteners. Snug, but **DO NOT TIGHTEN**.

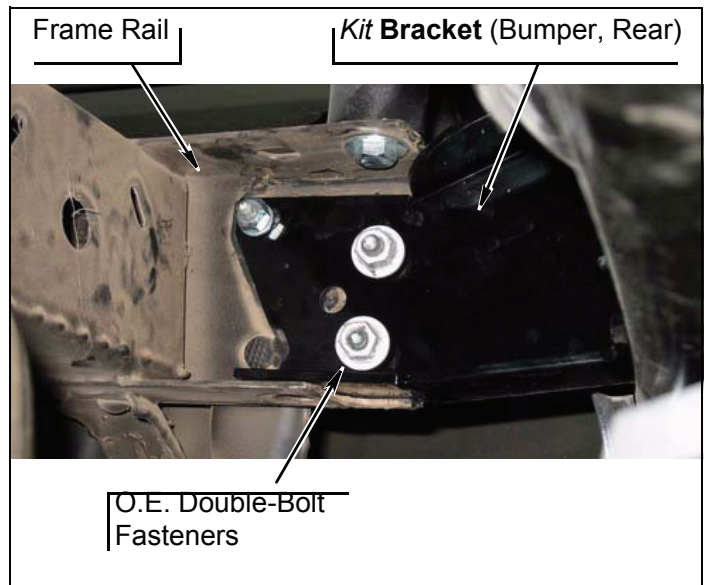

h. Mark eight holes through two **kit brackets** (bumper, rear) onto bumper support.

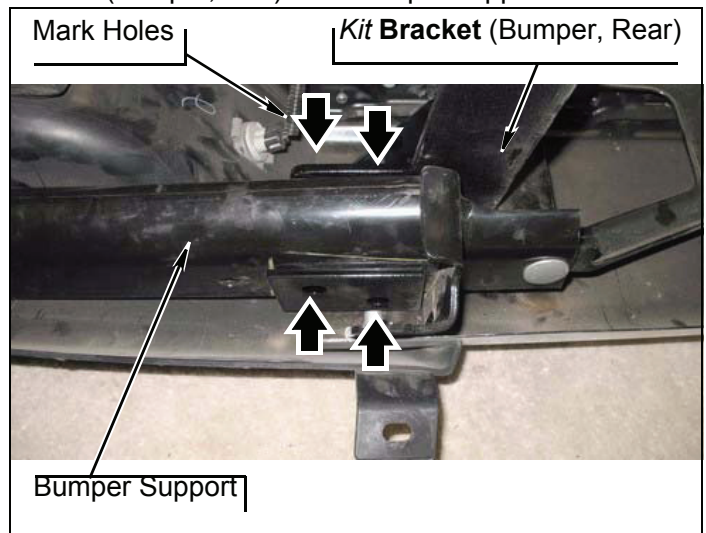

i. Remove two O.E. double-bolt fasteners, two nuts and bumper from frame rails.

j. Remove six nuts, two carriage bolts and bumper support from bumper.

k. Drill eight 1/2" holes through bumper support at marked locations.

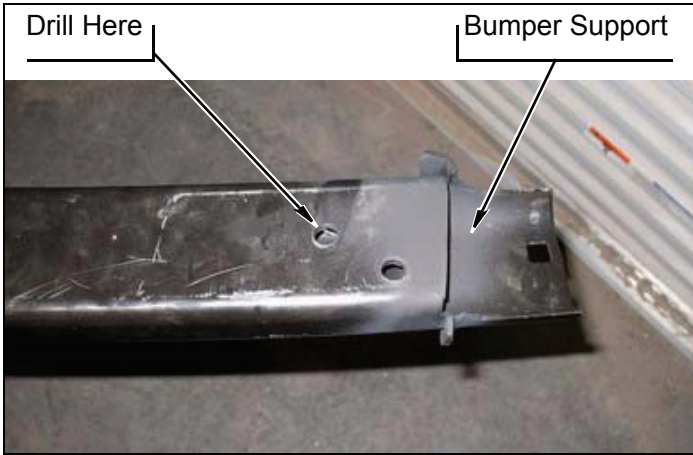

l. Install bumper support onto two *kit brackets* (bumper, rear) with four *kit bolts* (1/2"-13 x 3"), eight *kit washers* (1/2" SAE) and four *kit nuts* (1/2"-13 Stover). DO NOT TIGHTEN.

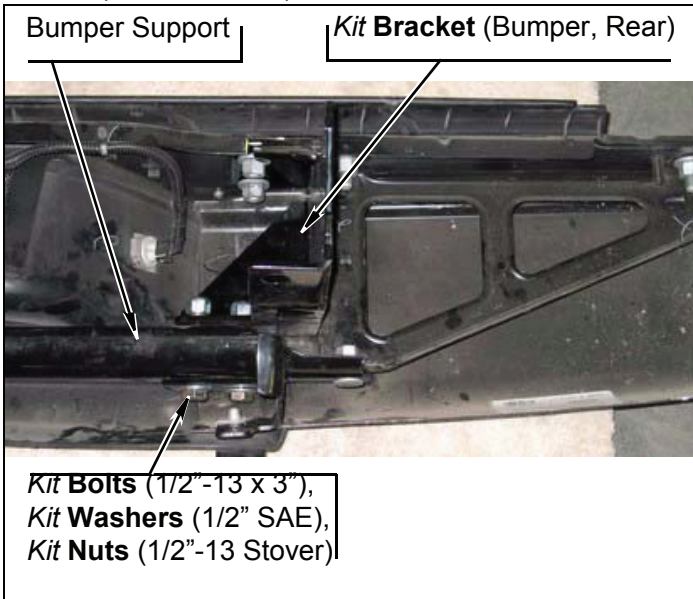

m. Install bumper support and two *kit brackets* (bumper, rear) onto bumper with two O.E. carriage bolts and six nuts. DO NOT TIGHTEN.

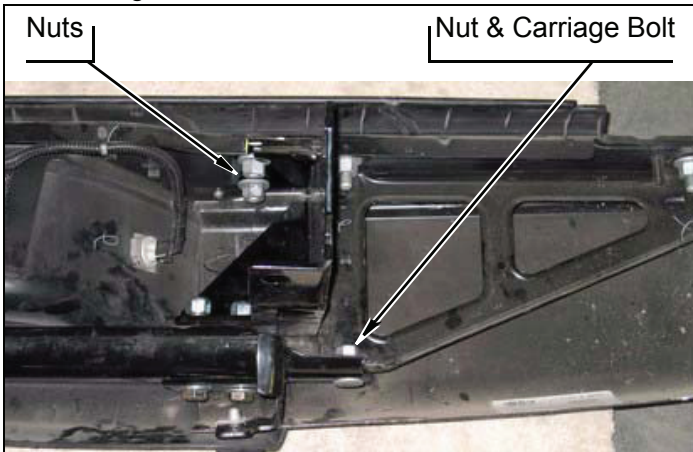

n. Install bottom of bumper onto bumper support with two bolts.

o. Install fascia onto bumper with two clips.

p. Install bumper onto frame rails with all O.E. double-bolt fasteners and nuts. DO NOT TIGHTEN...

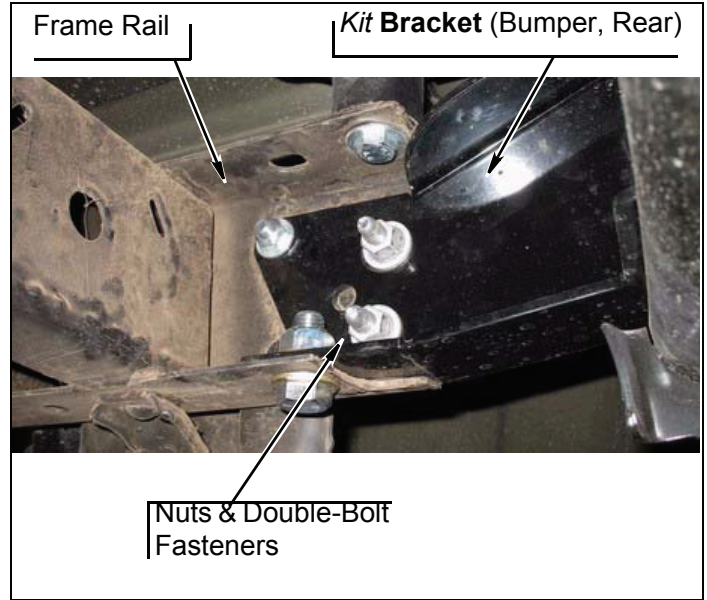

q. Install *kit bracket*, hitch spacer, on rear bumper and hitch with two *kit bolts* (14mm x 110mm) and two *kit washers* (14mm). Do not tighten.

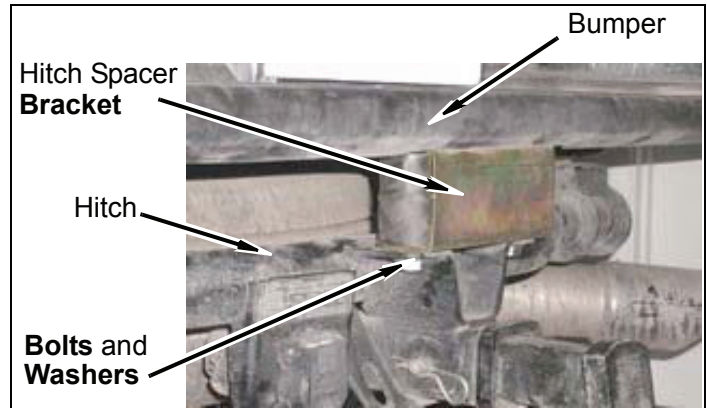

r. Adjust bumper to bed clearance using measurements taken earlier and tighten hitch bolts first then remaining bolts and nuts to 55 lb-ft.

- s. Plug license plate light harness in at crossmember connector.

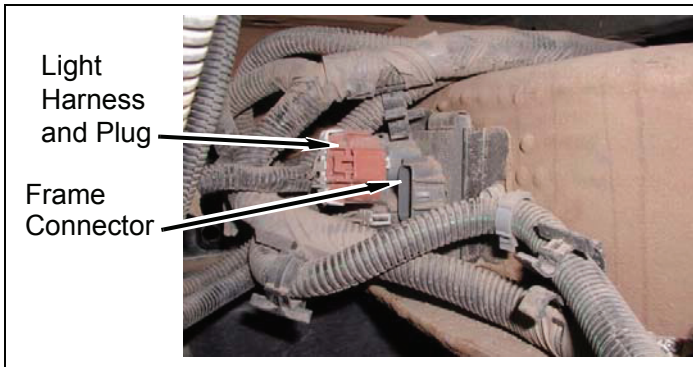

3. Fuel filler

⚠WARNING

Use extreme caution when working near fuel lines and fuel tank. Clean up spilled fuel immediately. Any spark could cause an explosion or fire resulting in serious personal injury and property damage.

- a. Install fuel filler on the bed with three bolts. Install fuel cap.

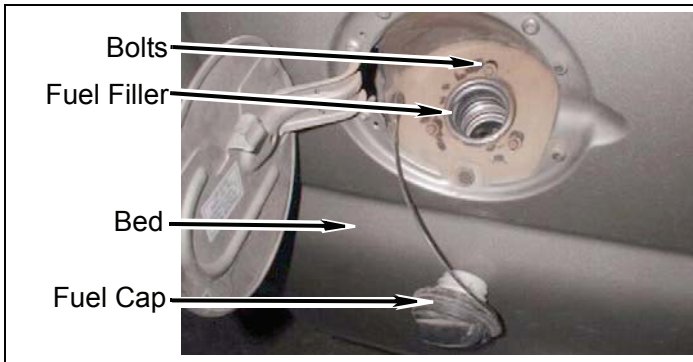

D. Frame

1. Safety cables, single cab only

- a. Install two kit **brackets**, safety cable extension on frame rear mounting pads with two bolts.

- b. Install two safety cables on kit **brackets**, safety cable extension with two kit **bolts** (3/8" x 1 1/2"), four kit **washers** (3/8" USS), and two **nuts** (3/8" nylock).

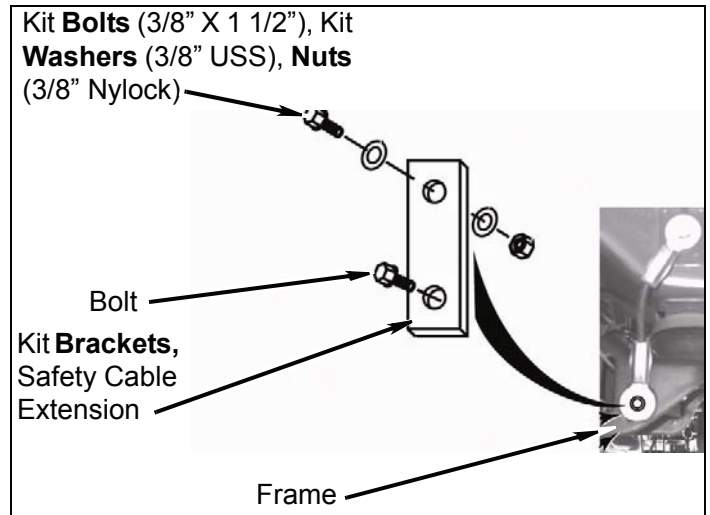

2. Parking brake cable.

⚠NOTE

Some filing of drilled 7/16" hole may be required to allow parking brake cable housing to fit properly.

- a. Using kit parking brake bracket as templet, mark & drill a 7/16" hole in the frame over original hole as shown.

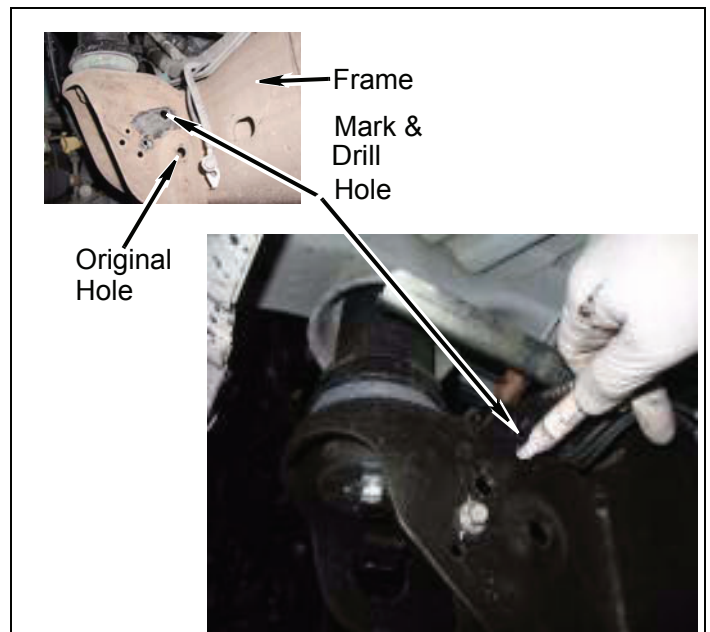

- b. Relocate parking brake cable into **kit park bracket** and mount using **kit 7/16"** hardware. .

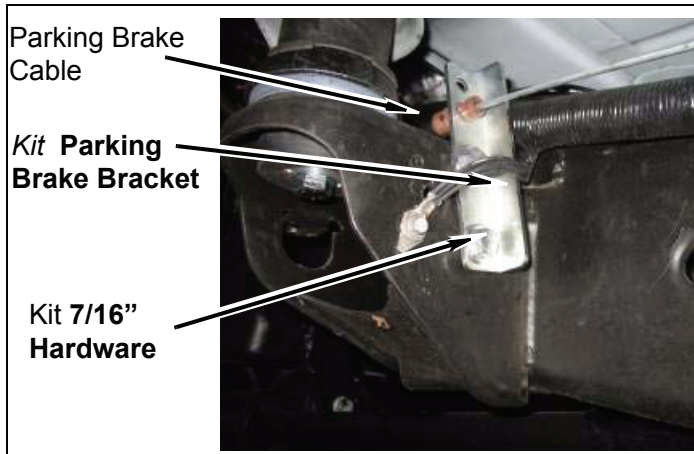

- c. Install two ground wires on frame mounting pad with bolt. Connect front and rear brake cables. Remove clamps from rear cable. **Note:** **Kit washer** may be used between **kit bracket** and body mount to keep bracket aligned.

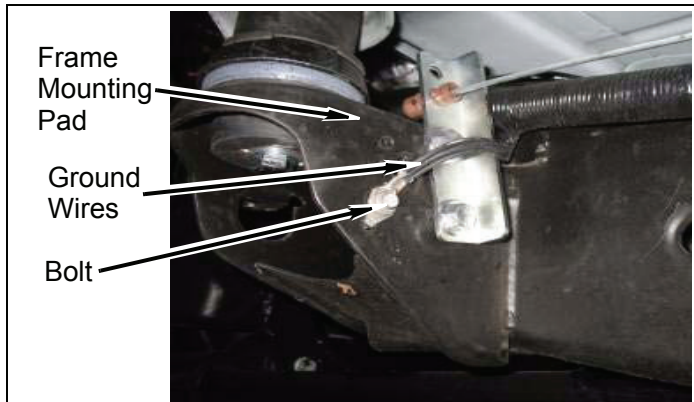

NOTE
The following step is for vehicles with manual transfer case only. Other models skip this step.

3. Lengthen and install transfer case shift lever.

- a. Remove two spring clips and transfer case linkage from shift lever, transfer case shift arm.

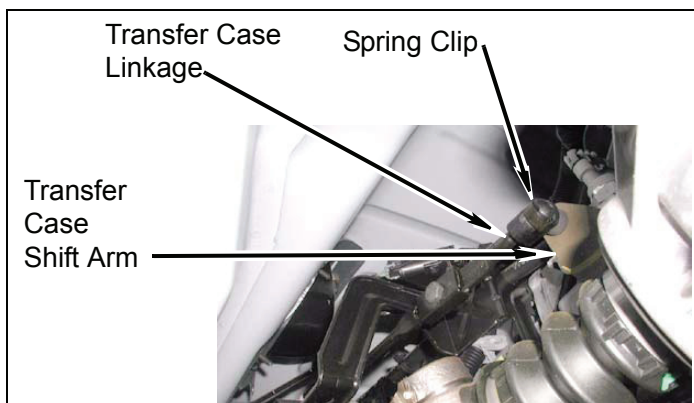

- b. Scribe a line along transfer case linkage as shown. Cut transfer case linkage into two pieces through the scribed line and deburr.

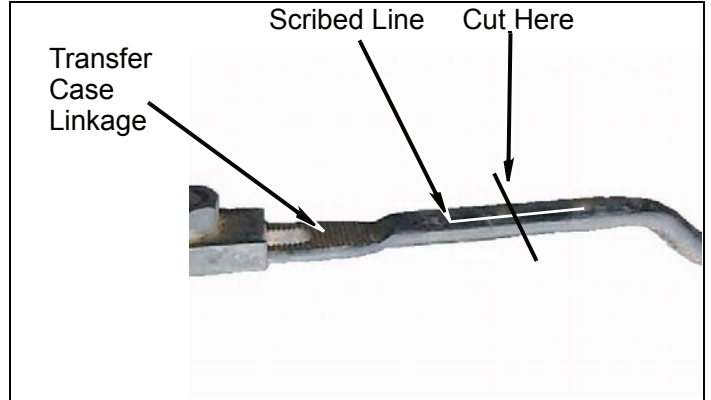

WARNING
A certified welder should perform all welding.

- c. Position **kit pin 4x4 extension** between two pieces of transfer case linkage. Ensure transfer case linkage scribed lines align and weld **kit pin** extension in place.

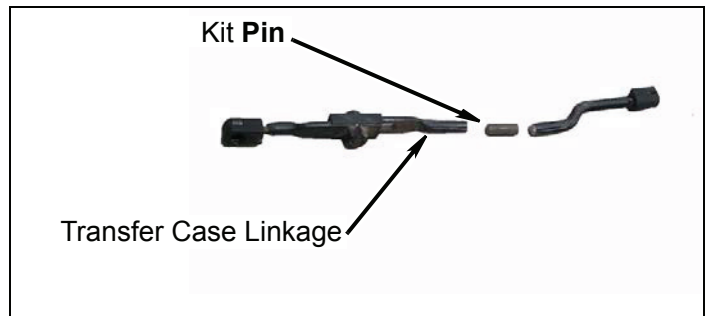

- d. Install transfer case linkage on transfer case shift arm and shift lever with two clips.

- e. Check transfer case shift lever operation. Ensure there is complete engagement in all ranges. If necessary, adjust the linkage.

4. **Manual transmission** shift lever.

NOTE
Manual transmissions require shift extension SE4701 **purchased separately**. Automatic transmission models skip this step.

5. Driver side wheel well and frame rail.

- a. If possible, install four harness clips on frame and wheel well.

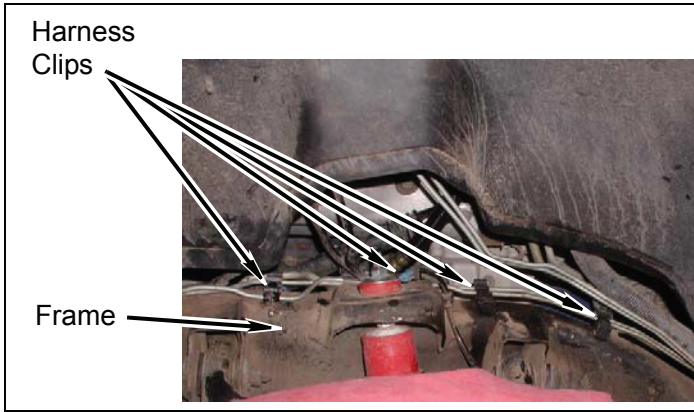

- b. If possible, install two brake lines in two sets of clips. If brake lines will not fit back into position, wrap lines with two kit zip ties individually, and then secure the lines together with one kit zip tie as a bundle.

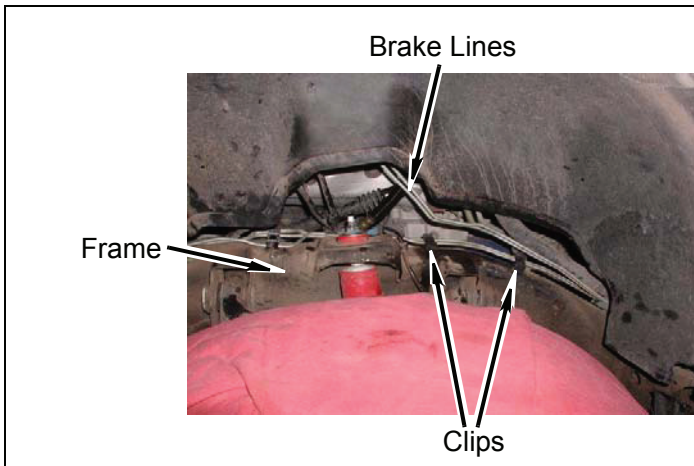

- c. If possible, install harness in clip on frame driver side.

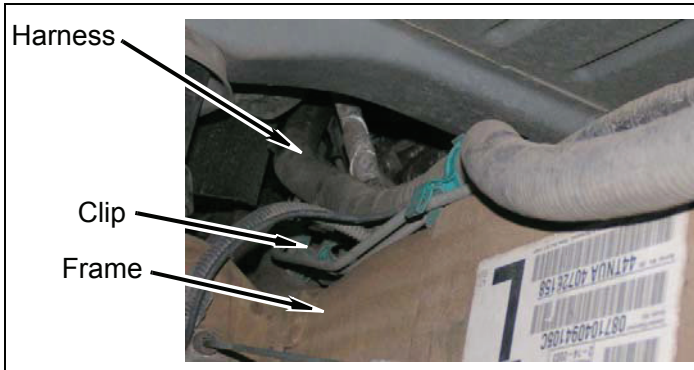

E. Engine Compartment

- 1. Intercooler piping passenger side

- a. Remove factory flex hose from Upper and Lower Piping. ****VERY CAREFULLY**** cut nylon clamps from Upper and Lower piping. ****Be sure NOT to cut factory flex hose during this process****

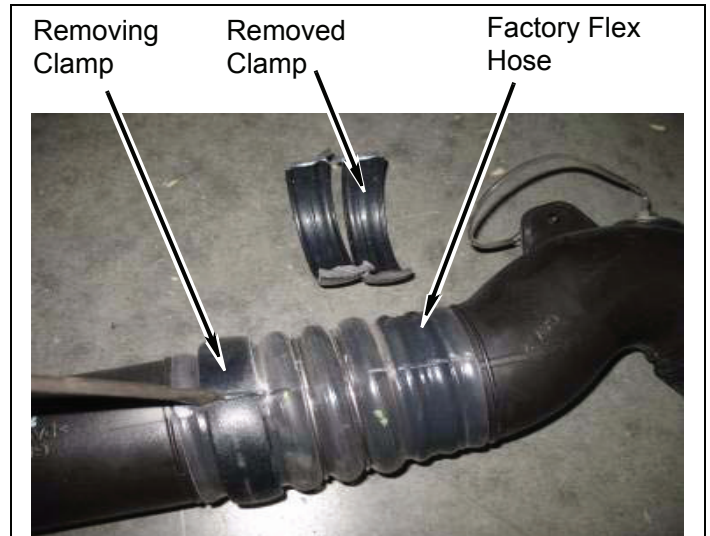

- b. *Measure and Cut* Upper and Lower intercooler pipes. *Measure and Mark* 3/4" from **EACH** end of the Upper and Lower intercooler pipes. *Carefully cut intercooler pipes without damaging inner metal support ring. Be sure to clean **ALL** metal & plastic particles from pipes.

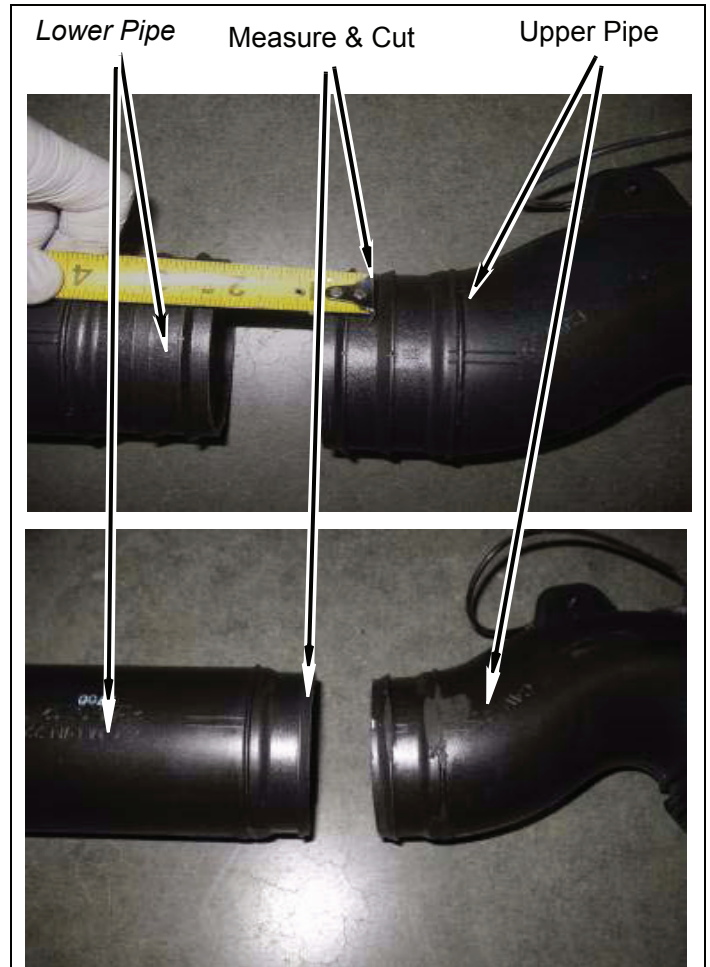

- c. ***Measure and Cut* O.E. Flex Hose.** *Measure and Mark* **3/4"** from **EACH** end of the Flex Hose. *Carefully cut Flex Hose. Be sure to clean **ALL** particles from Flex Hose.

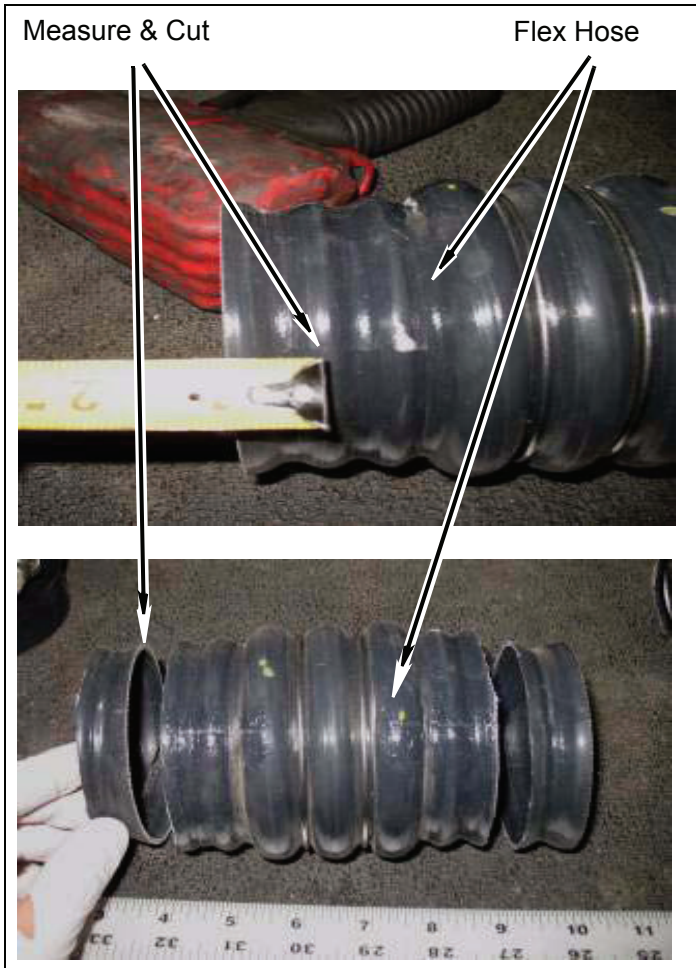

- d. Place O.E. Flex Hose onto Upper / Lower intercooler pipe. Install two **kit clamps** onto intercooler pipe and Flex Hose, **do not** tighten **kit clamps** at this time.

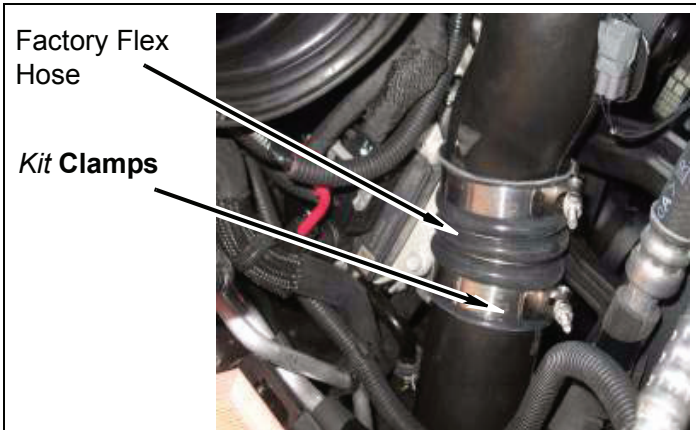

⚠WARNING
When installing factory hose clamps, make sure the clamp is not rubbing on other hoses once it is tight.

- e. Install factory upper and lower intercooler pipes onto throttle body and intercooler. Adjust and Tighten two **kit hose clamps** on O.E. Flex Hose.

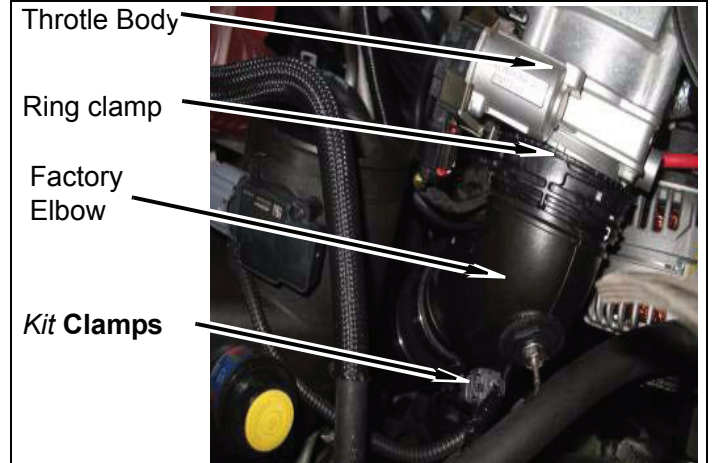

2. Intercooler piping drive side

- a. Position silicone elbow on intercooler and air pipe with two clamps.

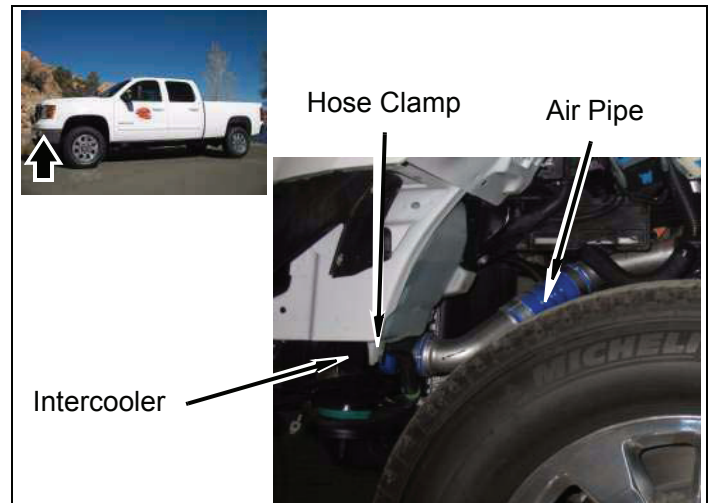

3. Wiring harnesses and ground strap

- a. If possible, install clip in bracket (*top of engine*).

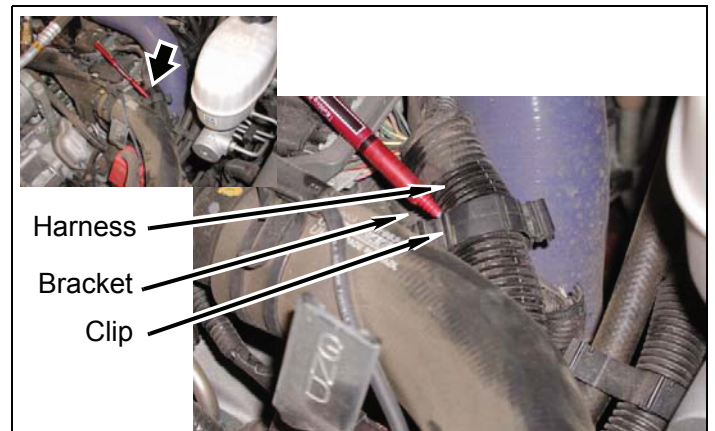

- b. Install ground strap on stud with nut.

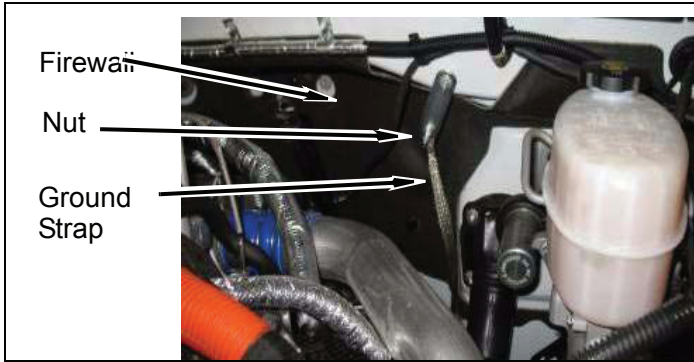

4. Install kit steering extension.

- a. Place a few drops of kit Loctite® on threads of bolts for both following steps.
- b. Install kit **steering extension** on upper steering shaft with kit **bolt** (3/8" x 1 3/4"), two kit **washers** (3/8" SAE), and kit **nut** (3/8" nylock). Do not tighten.
- c. Install kit **steering extension** into lower steering shaft with bolt and nut. Tighten bolt to 33 lb-ft.

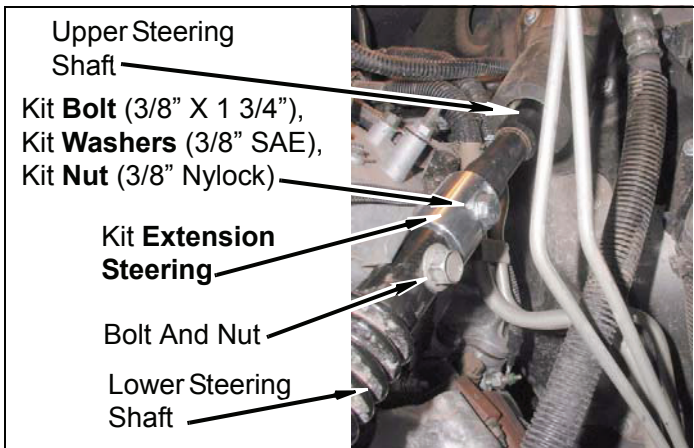

5. Lower fan shroud.

- a. Trim tabs from edges of lower fan shroud at mark, both sides, as shown.

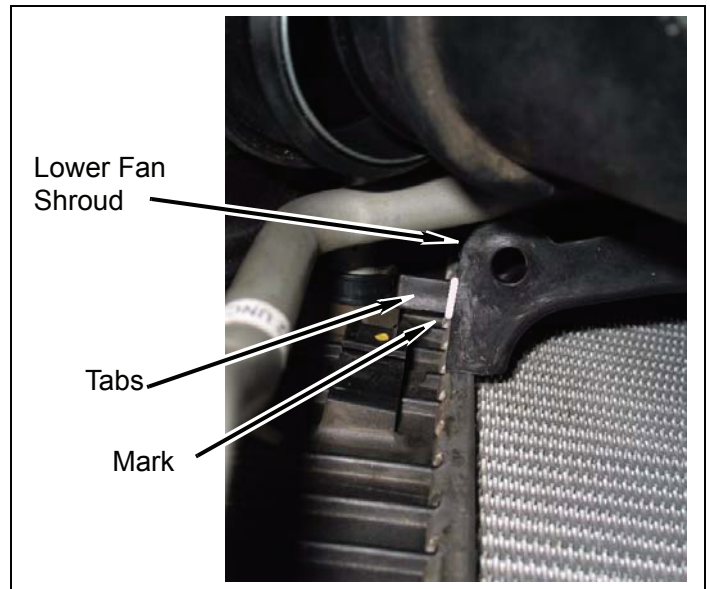

6. Upper fan shroud.

- a. Measure upper fan shroud from top down 1-1/2". Mark and cut upper fan shroud as shown.

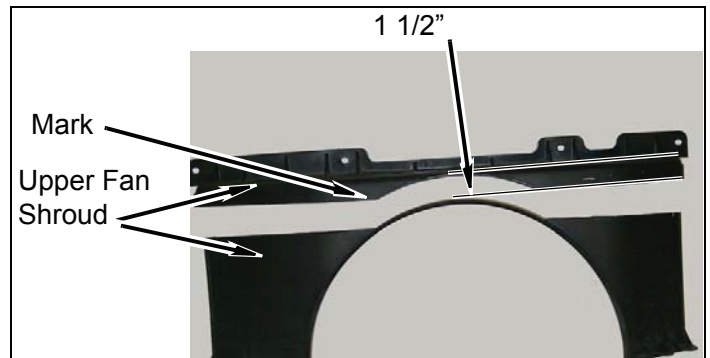

- b. Clamp fan shroud on table top as shown.

- c. Position kit **bracket, upper fan shroud** (center) on fan shroud with two tabs under shroud and edges on top of shroud as shown.

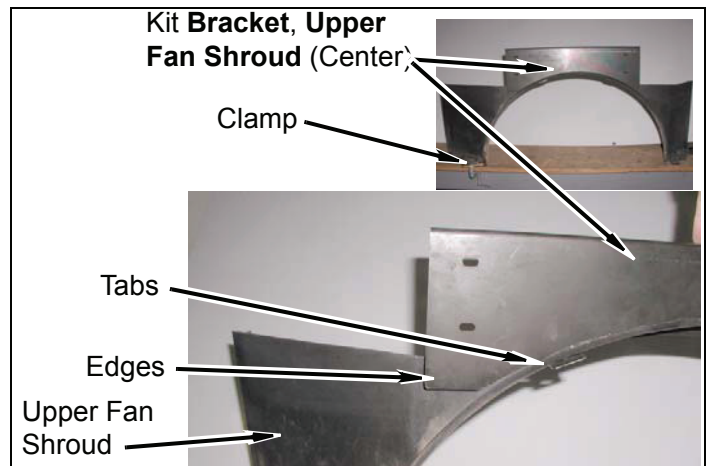

- d. Assemble three kit **brackets, upper fan shroud** (left, center, and right) with two kit **bolts** (1/4" x 3/4"), four kit **washers** (1/4" SAE), and two kit **nuts** (1/4" nylock) as shown. Snug, bolts but do not tighten.

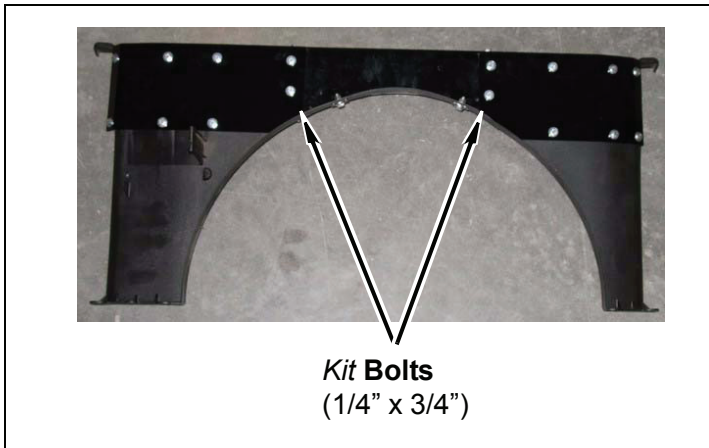

- e. Measure kit **bracket, upper fan shroud** (center) from table top as shown. Ensure bracket is level.

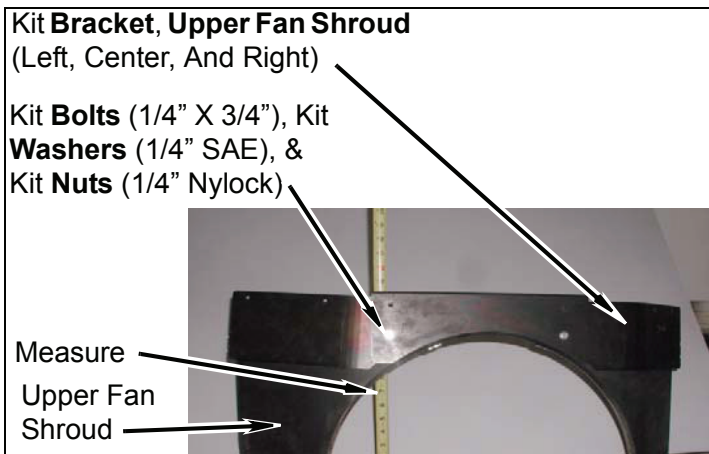

- f. Clamp two scrap pieces of metal (or rulers) to fan shroud as shown. Position upper fan shroud on metal scrap and under kit **bracket, upper fan shroud** (center).

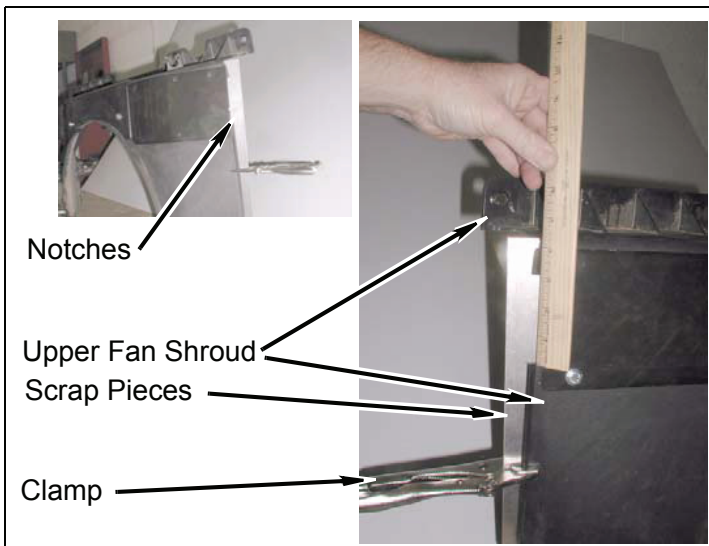

- g. Using three kit **brackets, upper fan shroud** (left, center, and right) as templates, drill 1/4" holes in fan shroud.
- h. Install three kit **brackets, upper fan shroud** (left, center, and right) on upper fan shroud with one kit **clips push**, fifteen kit **bolts** (1/4" x 3/4"), thirty kit **washers** (1/4" SAE), and fifteen kit **nuts** (1/4" Nylock).

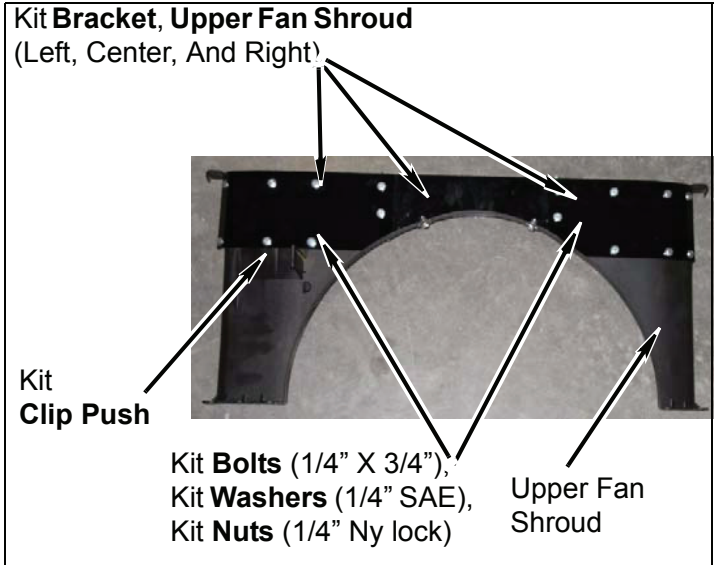

- i. Using kit **bracket, upper fan shroud** (center) as template, drill two 1/4" holes in fan shroud lip. Install kit **bracket, upper fan shroud** (center) on upper fan shroud lip with two kit **clips push**.

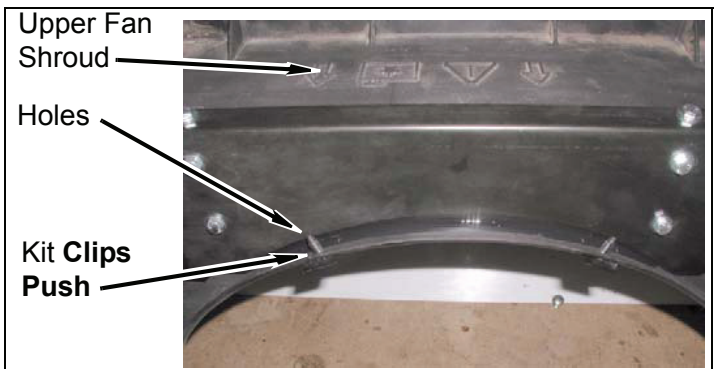

7. Lower fan shroud

- a.

- b. Position bottom fan shroud in vehicle and rest below lower core support.

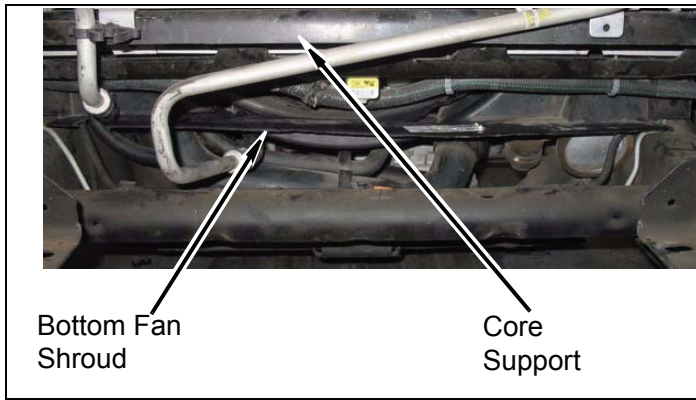

- c. Install upper fan shroud assembly on core support with two bolts. Do not tighten.

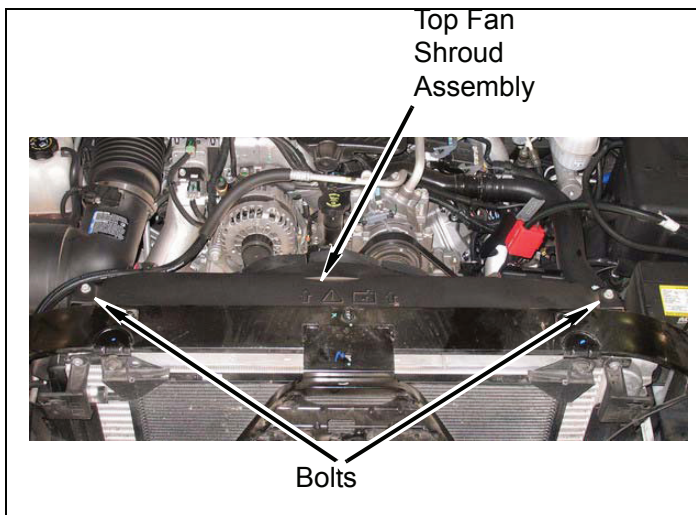

- d. Install top fan shroud on bottom fan shroud with four pop-ups. Check fan to shroud clearance. Ensure gap is the same all around shroud.

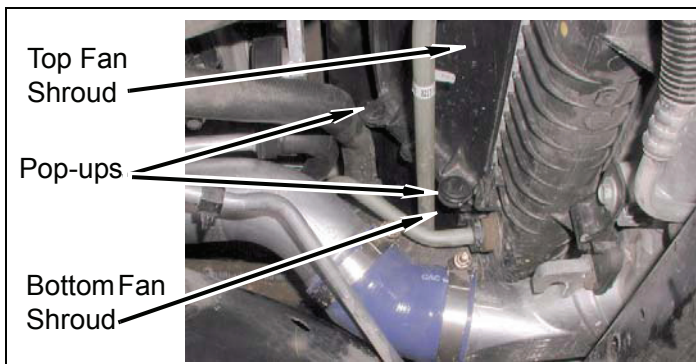

- e. Mark & Drill two holes in upper fan shroud bracket using computer module as a template. Install computer module on upper fan shroud with two pop-up clips.

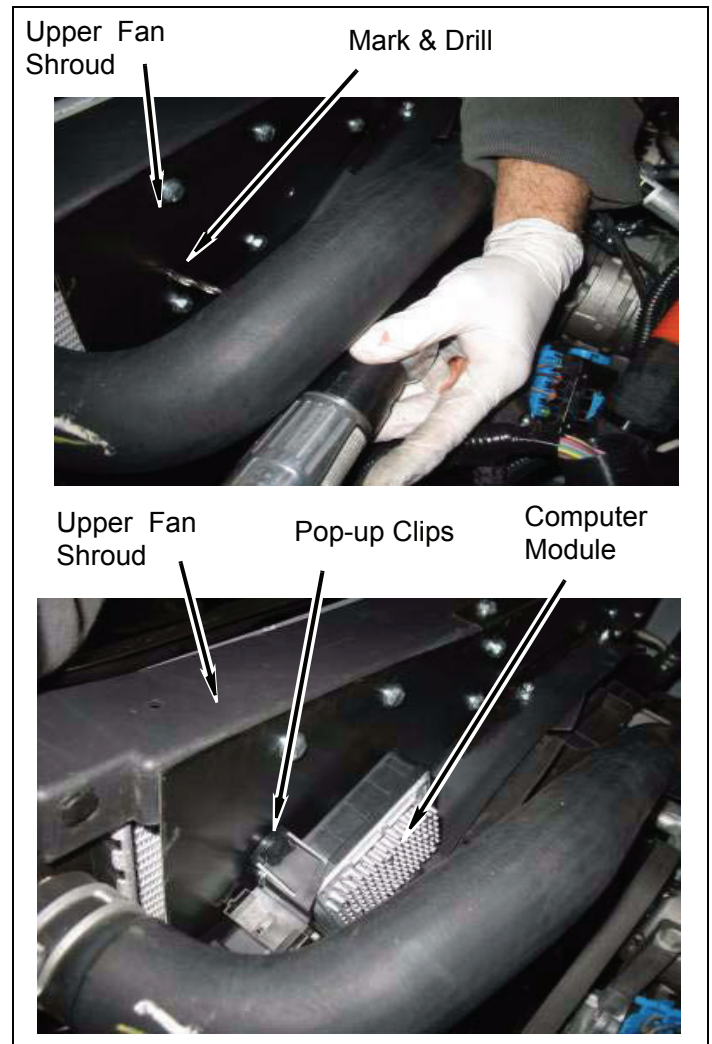

- f. Install three *kit lower fan shroud plates* with two *kit bolts* (1/4" x 3/4"), four *kit washers* (1/4" SAE), and two *kit nuts* (1/4" nylock).

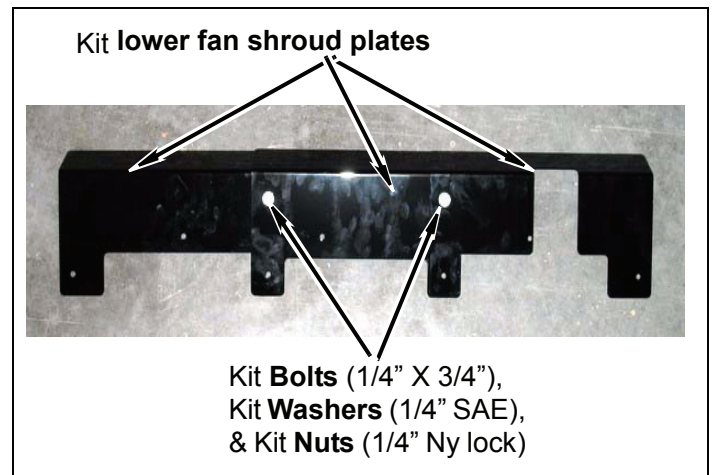

- g. Mark & Drill four 1/4" holes into core support using **kit lower fan shroud plates** (assembly) as template on core support.
- h. Install **kit lower fan shroud plates** (assembly) on core support with four **kit bolts** (1/4" x 3/4"), eight **kit washers** (1/4" SAE), and four **kit nuts** (1/4" nylock). Using fan shroud plates as template, mark and drill one 1/4" hole into center of fan shroud as shown. Install one **kit bolts** (1/4" x 3/4"), two **kit washers** (1/4" SAE), and one **kit nuts** (1/4" nylock).

- a. Install air box assembly in rubber grommets on fender and position air inlet hose on intake manifold.

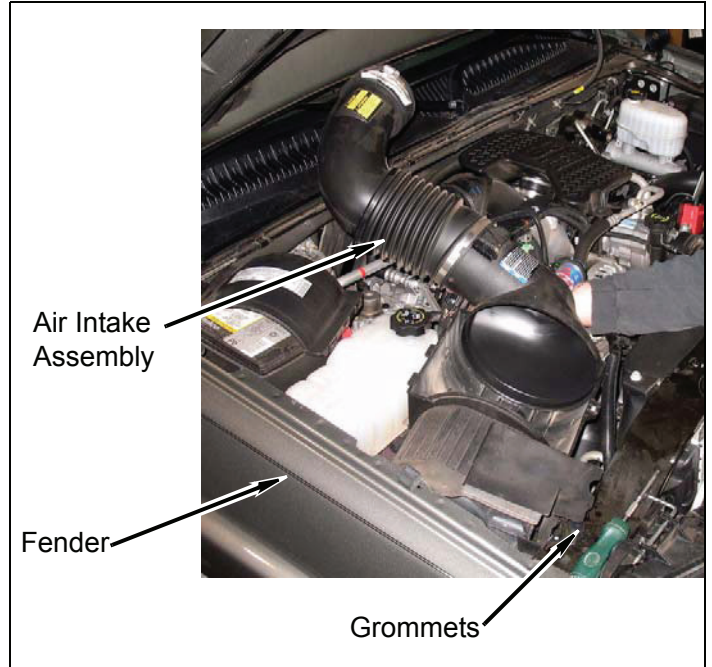
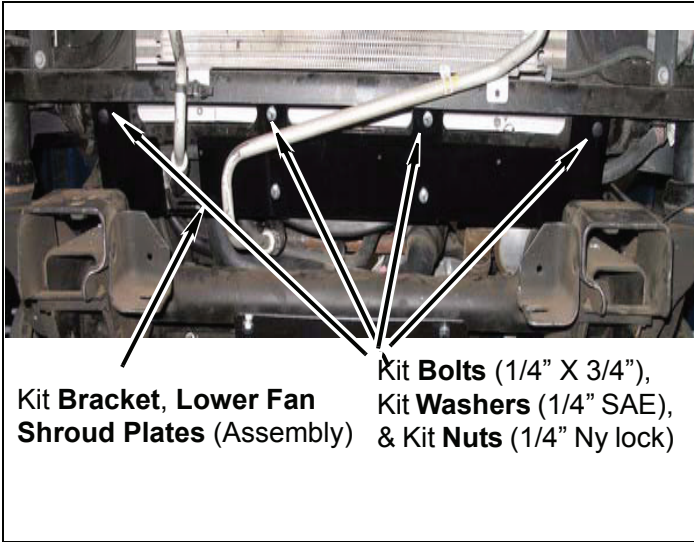

- b. Tighten clamp on air intake assembly. Install wire harness clip on sensor.

- i. Install Air Flap with three push pins in holes provided in **kit lower fan shroud plates**. Install two outer Air Flap clips.

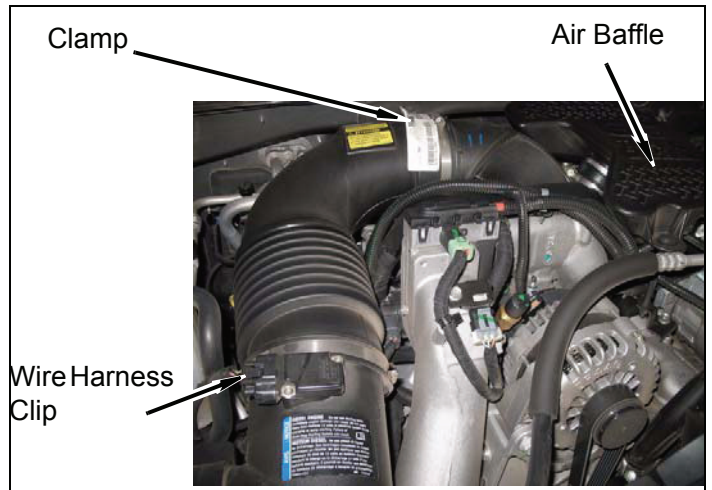

- c. Install A/C hose from clip on upper fan shroud.

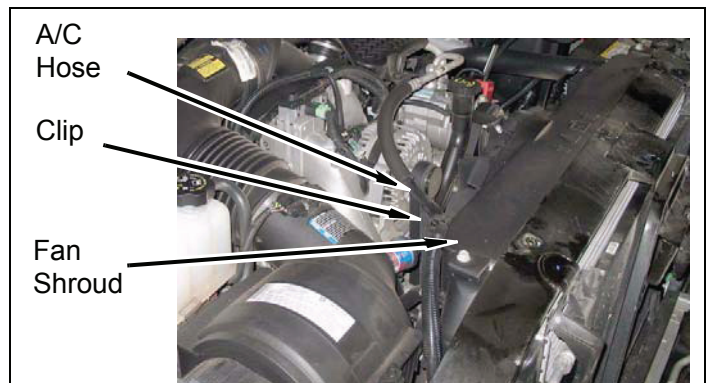
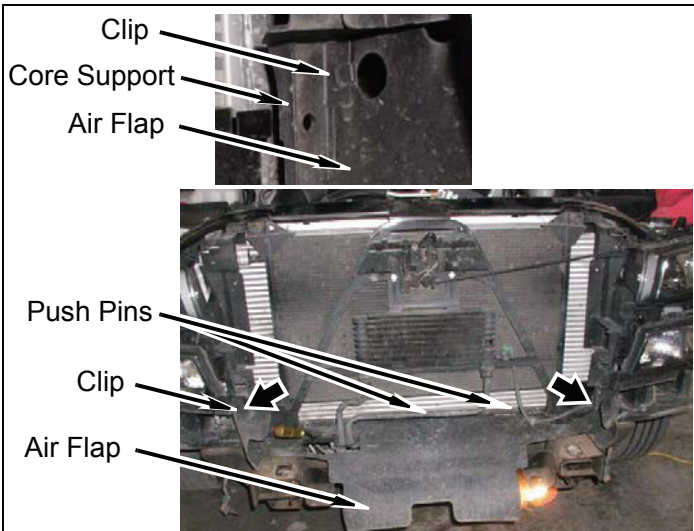

8. Air intake

F. Front of vehicle

1. Transmission cooler (If so equipped)

- install two **kit 2" studded drop brackets** with O.E. bolts into nut clips from transmission cooler. Install two **kit 1/4" studded brackets** in holes on core support A-frame using **kit 1/4" nuts & washers**.

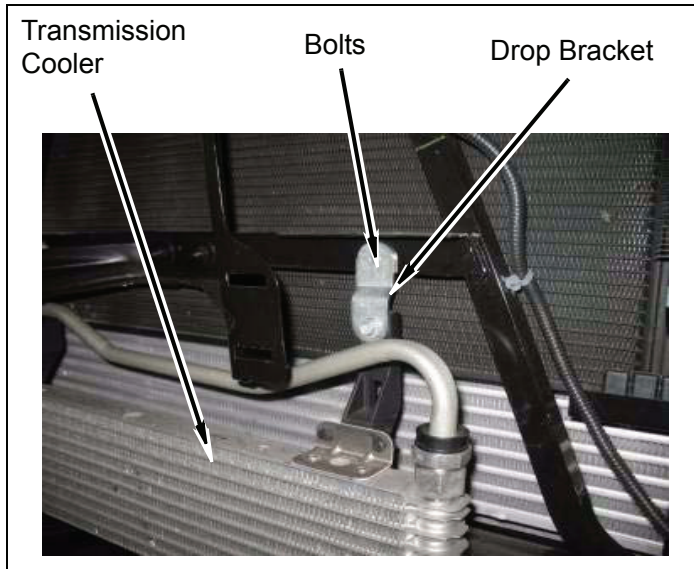

- Install two **kit Spacers** in between lower transmission cooler bracket and core support using **kit (3/8 x 2 1/2") hardware**.

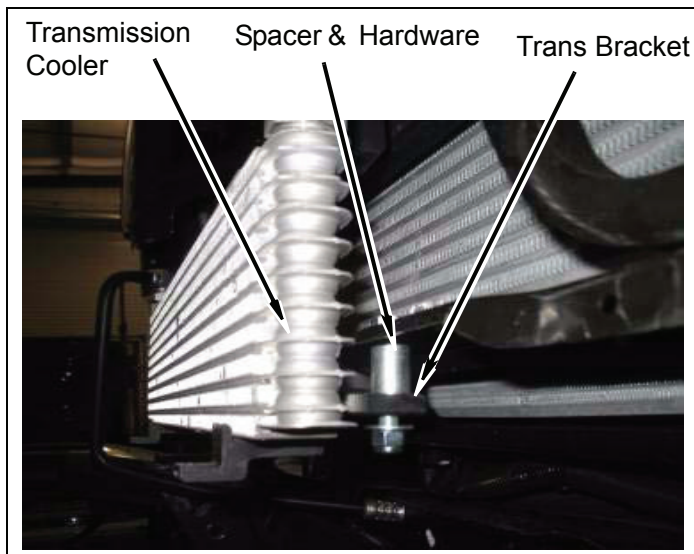

2. Plastic splash guard

- If removed, install clip and harness on air flap.

- Install plastic cover on frame and core support with five bolts.

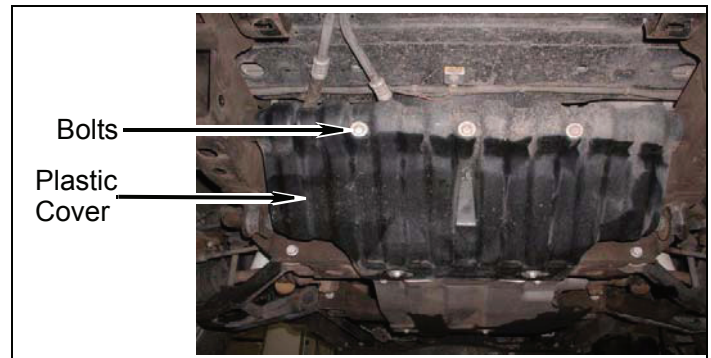

3. Install front bumper

- Place a few drops of kit Loctite® on threads of bolts.

NOTE

Kit washers (1/2" x 1-3/8") are fitted between **kit brackets** (bumper, front) and frame horn.

- Install **kit bracket** (bumper, front, left) and **kit bracket** (bumper, front, right) onto left frame horn with four **kit washers (1/2" x 1-3/8")**, four **kit bolts (1/2"-13 x 5-1/2")**, eight **kit washers (1/2" SAE)** and four **kit nuts (1/2"-13 Stover)**. DO NOT TIGHTEN.

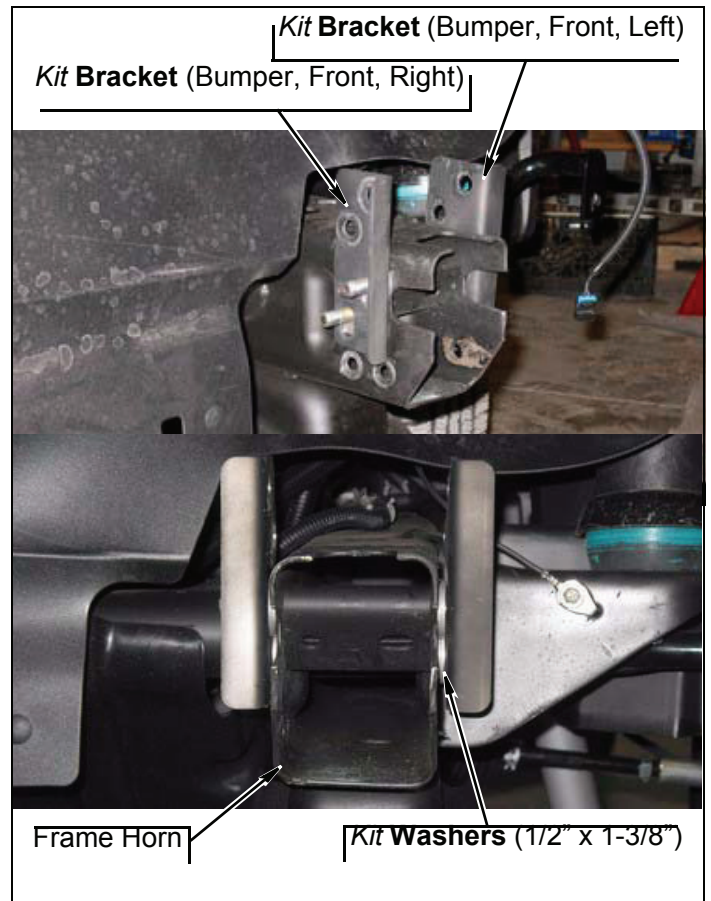

- c. Install frame bracket onto **kit brackets** (bumper, front) with two **kit sleeves** (.75" OD x .532" ID x 3.35" L), four **kit bolts** (1/2"-13 x 5-1/2"), eight **kit washers** (1/2" SAE) and four **kit nuts** (1/2"-13 Stover). DO NOT TIGHTEN.

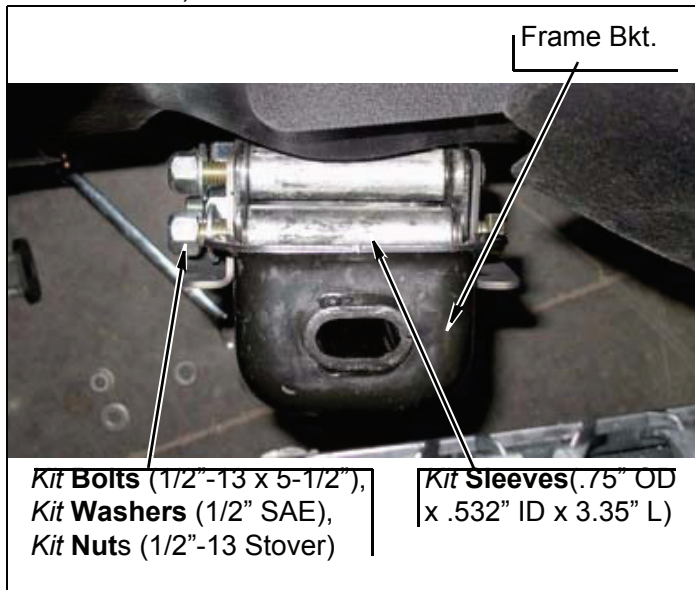

- d. Repeat above substeps for right frame horn.
 e. Install bumper onto frame brackets with two O.E. bolts. DO NOT TIGHTEN.

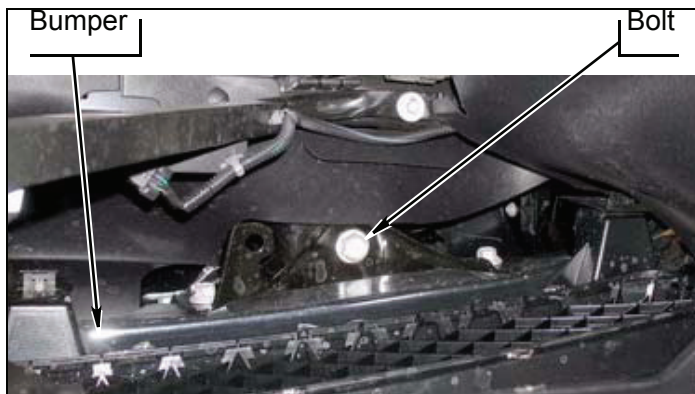

- f. Install two **kit brackets** (bumper, front, support) onto bumper with two **kit large washers** between bumper and kit bracket. DO NOT TIGHTEN

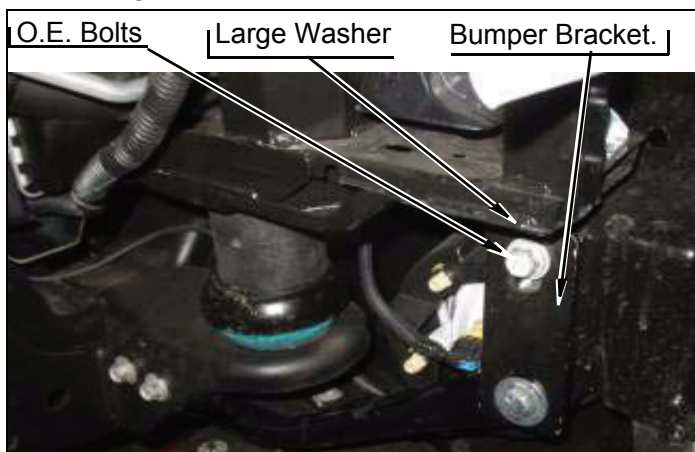

- g. Install two bumper supports onto kit brackets with two **kit bolts** (7/16"-14 x 1-1/2"), four **kit washers** (7/16" SAE), two **kit nuts** (7/16"-14 Stover) with four O.E. bolts to body mount. DO NOT TIGHTEN.

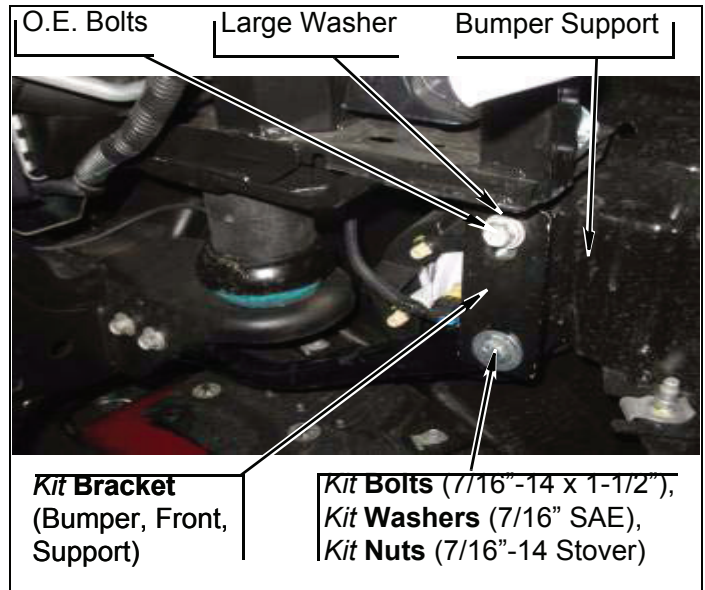

- h. Adjust bumper to body clearance using measurements from removal section. Align bumper to previous measurements and TIGHTEN all bumper hardware.
 i. If so equipped, install two connectors on two fog lamps.

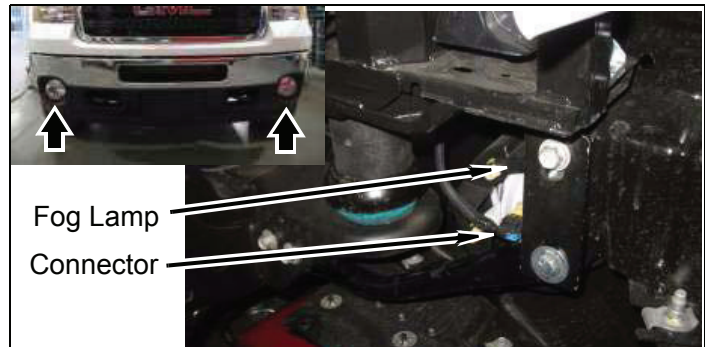

4. Install Front Grill

- a. Remove two bolts from each fender side and remove bumper face from core support and fenders .

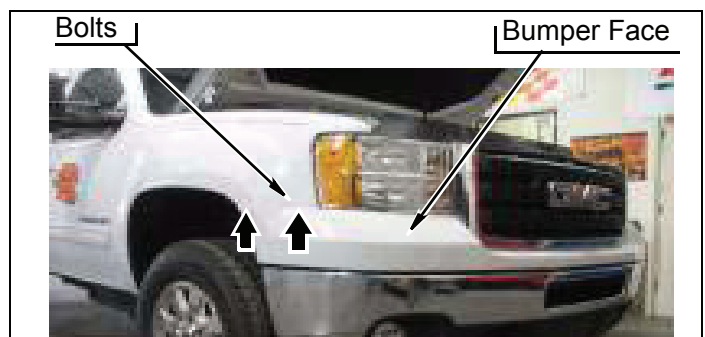

- b. Position grill on core support and install six clips and four bolts in core support and front fenders.

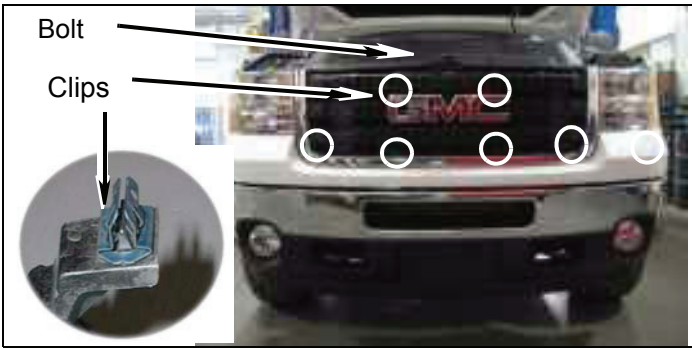

- c. Install cover on core support with seven push pins.

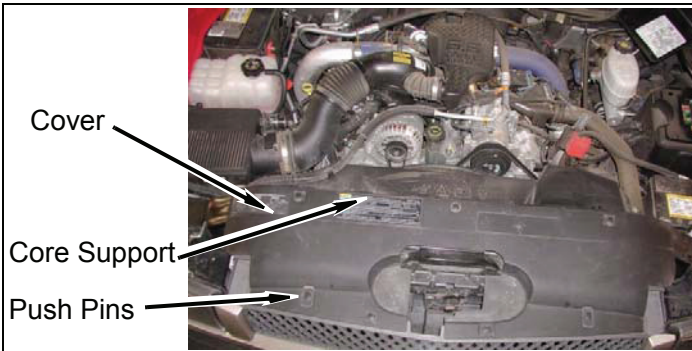

5. Install crush blocks

NOTE
Short wheel base trucks have two plastic disks and use two *kit* crush blocks.

- a. Remove four plastic disks from frame.
- b. Install four kit **crush blocks** on frame with four kit **washers** (5/16" USS) and four kit **screws** (5/16" x 3/4" self tapping).

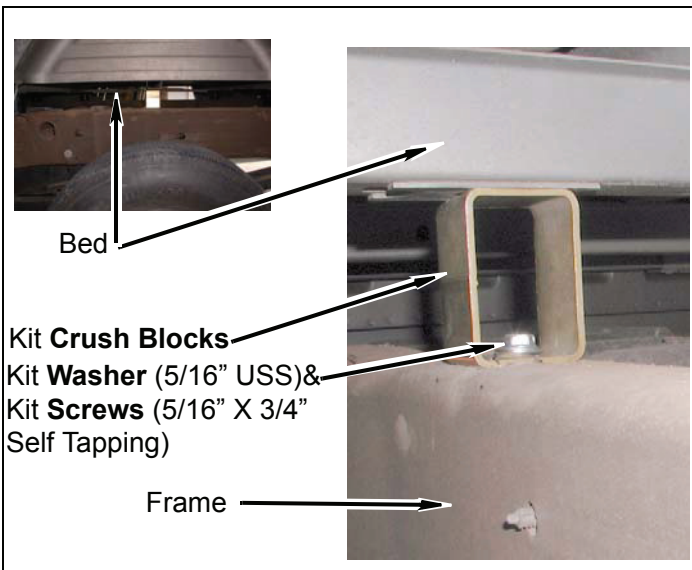

G. After installation is complete

1. Install airbag fuse in fuse panel. Install cover



2. Connect both battery cables to the battery. Be sure to reconnect the positive cables first, then the negative cables.

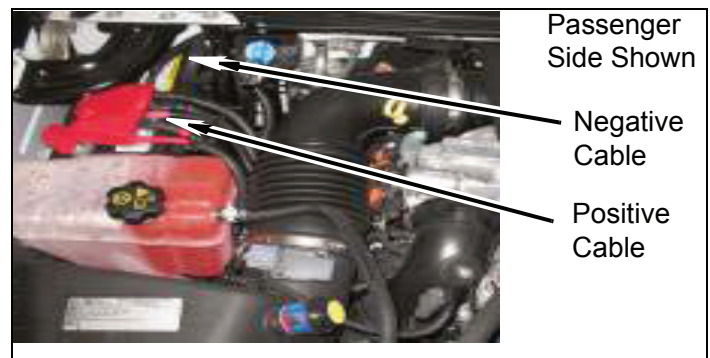

3. Install Gap Guards (you did remember to order your Gap Guards, didn't you?).
4. Stick kit **warning sticker** on the dash in plain sight of all vehicle occupants.
5. Double check the vehicle.

CAUTION
Retorque all fasteners after 500 miles and after off road use. All body lift components should be visually inspected and fasteners re torqued during routine vehicle servicing.

- a. Check all mounting hardware to ensure it is properly tightened.
- b. Check all wires, hoses, cables, etc. to ensure they have been properly connected and there is ample slack. Check all belts and pulleys to ensure there is no rubbing or interference. With the number of hoses on this vehicle, it is vital that this be checked thoroughly.
- c. Check vehicle electrical system.

- d. Start vehicle and check the steering in both directions to ensure that there is no bind. Check clutch operation. Check the operation of the brake system and the parking brake. Check both shift levers' operation. Ensure that there is proper engagement in all gears and 4 wheel drive ranges.

⚠CAUTION

Never open a closed cooling system after the vehicle has been started. Only fill the cooling system if the cap has been removed while the vehicle was still cold.

- e. Check coolant level. Fill coolant to the proper level (refer to the Owner's Manual).
- f. Test drive vehicle in all gears and 4 wheel drive ranges. Pay close attention to all vehicle systems. Check all hardware again in 500 miles and as part of your regular maintenance schedule.

⚠NOTE

All warranty information, instruction sheets, and other documents regarding the installation of this product must be retained by the vehicle owner. Information contained in the instructions and on the warranty card will be required for any warranty claims. The vehicle owner needs to understand the modifications made to his vehicle and how they affect vehicle handling and performance. Failure to provide the customer with this information can result in damage to the vehicle and severe personal injury.

⚠CAUTION

Performance Accessories does not recommend any particular wheel and tire combinations for use with its body lifts and cannot assume responsibility for the customer's choice of wheels and tires. Reference your owner's manual for recommended tire sizes and warnings related to the use of oversized tires. Larger wheel and tire combinations increase stress and wear on steering and suspension components, which leads to increased maintenance and higher risk for component failure. Larger wheel and tire combinations also alter speedometer calibration, braking effectiveness, center of gravity, and handling characteristics. Consult with an experienced local off road shop to find what wheel and tire combinations work best with your vehicle.

PARTS LIST KIT 10253

QTY DESCRIPTION

4 **Bolt**, 1/2 x 3"
8 **Bolt**, 1/2"-13x5-1/2"
30 **Bolt**, 1/4 x 3/4
2 **Bolt**, M10-1.5x40mm
8 **Bolt**, 12-1.75 x 100mm
2 **Bolt**, 12-1.75 x 180mm
6 **Bolt**, 14-2.00 x 180mm
2 **Bolt**, 14-2.00 x 110mm
2 **Bolt**, 3/8 x 2 1/2"
1 **Bolt**, 3/8 x 1 3/4"
4 **Bolt**, 7/16 x 1 1/2"
4 **Bracket**, z-shaped, 2"
1 **Bracket**, ground, 3"
2 **Bracket**, front bumper driver side
2 **Bracket**, front bumper outer
2 **Bracket**, front bumper passenger side
1 **Bracket**, rear bumper driver side
1 **Bracket**, rear bumper passenger side
1 **Bracket**, hitch spacer
1 **Bracket**, lower fan shroud center
1 **Bracket**, lower fan shroud driver side
1 **Bracket**, lower fan shroud passenger side
1 **Bracket**, upper fan shroud center
1 **Bracket**, upper fan shroud driver side
1 **Bracket**, upper fan shroud passenger side
1 **Bracket**, parking cable extension
4 **Crush** block with hole
2 **Clamp**, 3" Clamp
1 **Label**, logo
1 **Label**, warning
1 **Loctite**, 6ml
12 **Nut**, 1/2-13 Nylock
35 **Nut**, 1/4 Nylock
2 **Nut**, M10-1.5 Stover
2 **Nut**, 14mm Nylock
3 **Nut**, 3/8 Nylock

20 **Nut**, 7/16 Nylock
1 **Pin**, 4x4 extension, 1/2" X 1"
4 **Screw**, 5/16 x 3/4, self-tapping
16 **Lift** block, 3" height x 3" diameter w/ 5/8" Hole
4 **Sleeve**, .75" ODx.532" IDx3.35" L
1 **Steering** extension
10 **Washer**, 1/2"x1-3/8"
24 **Washer**, 1/2" USS
65 **Washer**, 1/4" SAE
10 **Washer**, 14mm
2 **Washer**, 3/16" x 1 1/2" x 2 1/2"
2 **Washer**, 3/8" SAE
4 **Washer**, 3/8" USS
4 **Washer**, 5/16" USS
24 **Washer**, 7/16" USS
8 **Zip tie**

Copyright 1/11
Performance Automotive Group