



3651 N Highway 89 • Chino Valley, AZ 86323
(928) 636-7080

DODGE DAKOTA 3" KIT INSTALLATION INSTRUCTIONS 2000-2002 **KIT# 60043**

⚠ WARNING

Installation of a Performance Automotive Group body lift kit will change the vehicle's center of gravity and handling characteristics both on- and off-road. You must drive the vehicle safely! Extreme care must be taken to prevent vehicle rollover or loss of control, which could result in serious injury or death. Avoid sudden sharp turns or abrupt maneuvers and always make sure all vehicle occupants have their seat belts fastened.

⚠ WARNING

Before you install this kit, read and understand all instructions, warnings, cautions, and notes in this instruction sheet and in the vehicle owner's manual.

⚠ CAUTION

Proper installation of this kit requires knowledge of the factory recommended procedures for removal and installation of original equipment components. We recommend that the factory shop manual and any special tools needed to service your vehicle be on hand during the installation. Installation of this kit without proper knowledge of the factory recommended procedures may affect the performance of these components and the safety of the vehicle. We strongly recommend that a certified mechanic familiar with the installation of similar components install this kit.

⚠ WARNING

DO NOT combine suspension, body, or other lift devices. Use of vehicle with combined lifts may result in unsafe and/or unexpected handling characteristics.

⚠ WARNING

This kit should only be installed on a vehicle that is in good working condition. Before you install the kit, thoroughly inspect the vehicle for corrosion or deformation of the sheet metal around the factory body mounts. If the vehicle is suspected to have been in a collision or misused, do not install this kit. Off-road use of your vehicle with this kit installed may increase the stress applied to the factory body mounts. We do not recommend that any vehicle with a body lift kit installed be involved in any extreme off-road maneuvers such as jumping. Failure to observe this warning may result in serious personal injury and/or severe damage to your vehicle.

⚠ WARNING

Many states and municipalities have laws restricting bumper heights and vehicle lifts. Consult state and local laws to determine if the changes you intend to make to the vehicle comply with the law.

⚠ WARNING

The installation of larger tires may reduce the effectiveness of the braking system.

⚠ WARNING

Always wear eye protection when operating power tools.

⚠ WARNING

Before you install this kit, block the vehicle tires to prevent the vehicle from rolling.

⚠ WARNING

Accidental deployment of the air bag can result in serious personal injury or death. To avoid accidental deployment during installation of the kit, the Supplemental Restraint System (SRS, or airbag) must remain deactivated. Do not allow anyone near the airbag during installation. Refer to the factory service manual or owner's manual for the recommended procedure to disable the SRS. After you install the kit, reactivate the SRS before driving the vehicle.

NOTE

Performance Automotive Group recommends using the Loctite® supplied in the kit on the threads of all kit nuts and bolts unless specified otherwise in these instructions.

A. Before you start

NOTE

As you read through this procedure, note that each part referenced has the same callout number throughout. Also, the part number in the text matches the corresponding part number in the art. Kit parts are prefaced by the word *kit* in italics.

1. Read all warnings and instructions completely and carefully before you begin.
2. Check to make sure the kit is complete (refer to the Parts List, section E).
3. Only install this kit on the vehicle for which it is intended. If anytime during the installation you encounter something different from what is outlined in the instructions, call technical support at (928) 636-7080.
4. Park the vehicle on a clean, dry, flat, level surface and block the tires so the vehicle cannot roll in either direction.
5. Lower spare tire (1) to the ground (refer to the owner's manual).
 - a. Remove clip (2) and crank rod (3) from winch (4).
 - b. Remove crank rod (3) and plastic collar (5) from bed (6).
6. Disconnect both battery cables. Disconnect the negative cable (7) first, then the positive cable (8). Remove battery (9) from vehicle (refer to the owner's manual).

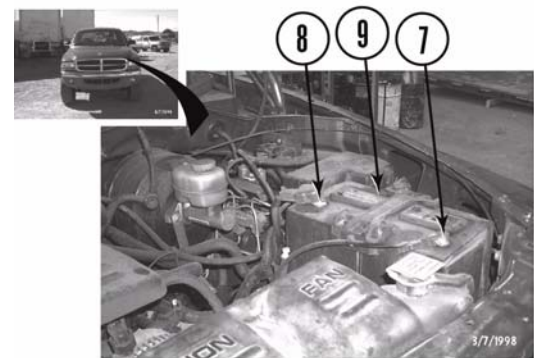
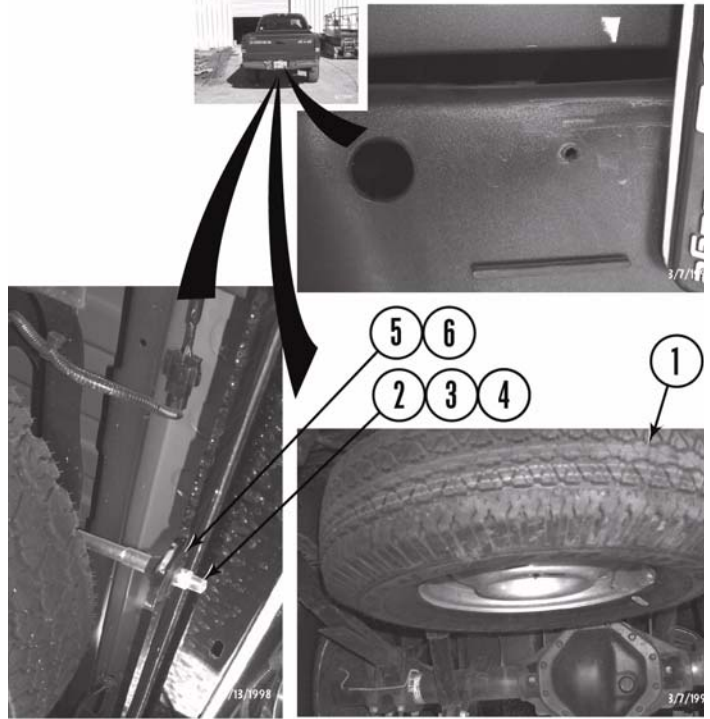

⚠ WARNING

Accidental deployment of the air bag can result in serious personal injury or death. To avoid accidental deployment during installation of the lift kit, the Supplemental Restraint System (SRS, or airbag) must remain deactivated. Do not allow anyone near the airbag during installation. Refer to the factory service manual or owner's manual for the recommended procedure to disable the SRS. After kit installation, the SRS must be reactivated before driving the vehicle.

7. Remove two air bag fuses (10) from the fuse box (11) (see the owner's manual for fuse location).

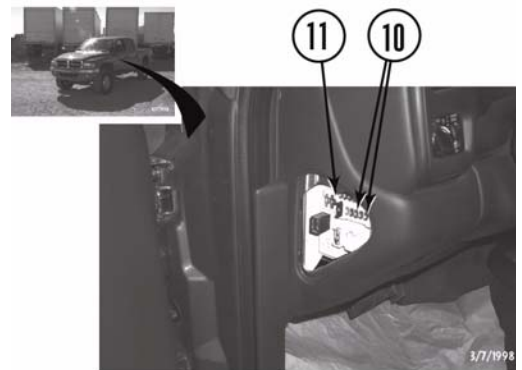

B. Get ready to install the kit.

1. Manual Transmission Models: Shift Lever

- a. Remove six screws and upper shift boot from shift console. Slide shift boot up the upper shift lever.
- b. Remove upper shift lever from lower shift lever. Remove upper shift lever and upper boot from vehicle.
- c. Remove six screws and shift console from cab floor.
- d. Remove six screws and lower shift boot from cab floor.
- e. Remove dust cover, four screws, and locking plate from shift tower.
- f. Remove locking plate, washer, lower shift lever, pivot pins, and insulator from shift tower.

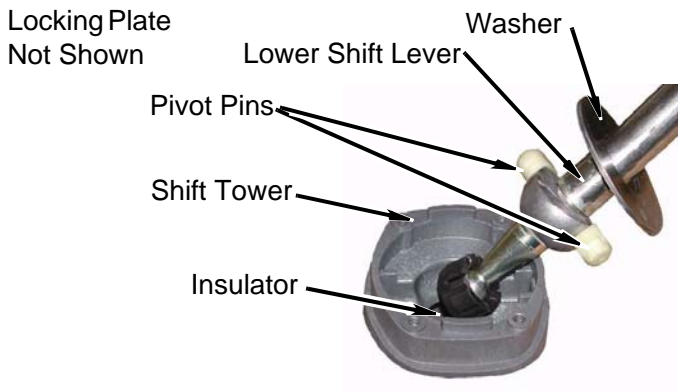
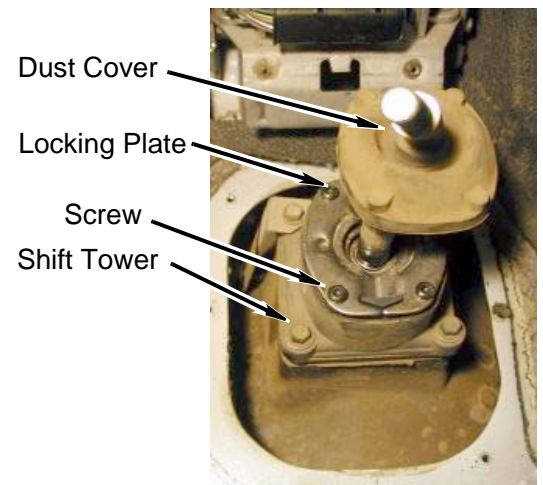
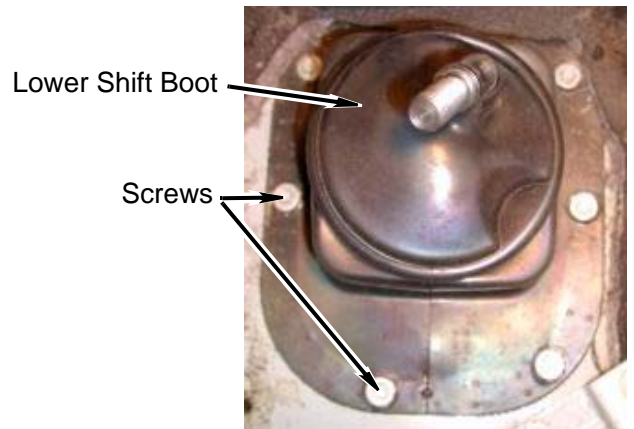
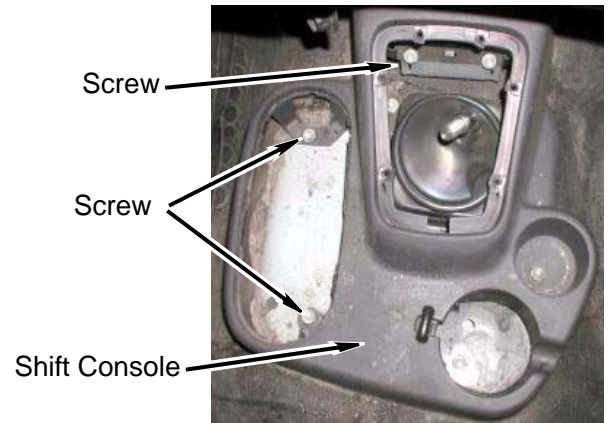
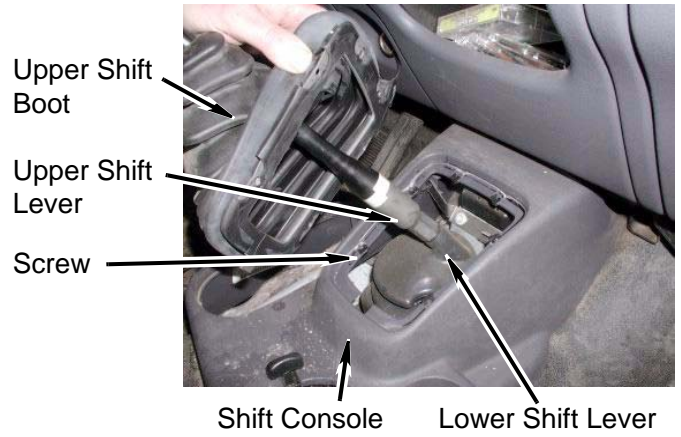

2. **4WD Models:** Remove the shift transfer case shift linkage.

a. If present on your vehicle, remove four bolts (12) and skid plate (13) from the frame (14) under the transmission and transfer case.

b. Remove two rubber bushings (15) and transfer case shift linkage (16) from shift lever (17) and transfer case (18).

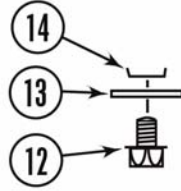
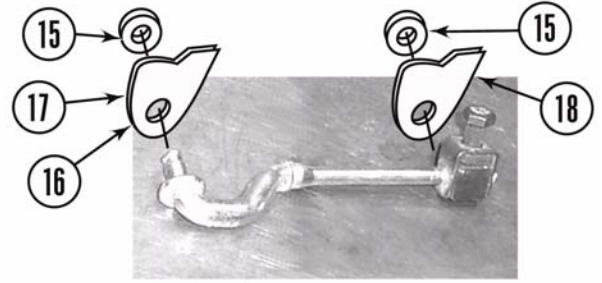

3. Remove the front bumper.

a. Remove nine panel clips (19), plastic cover (20), and rubber cover (21) from the core support (22).

b. If present on your vehicle, disconnect two wire harness connectors (23) from the driving lights (24).

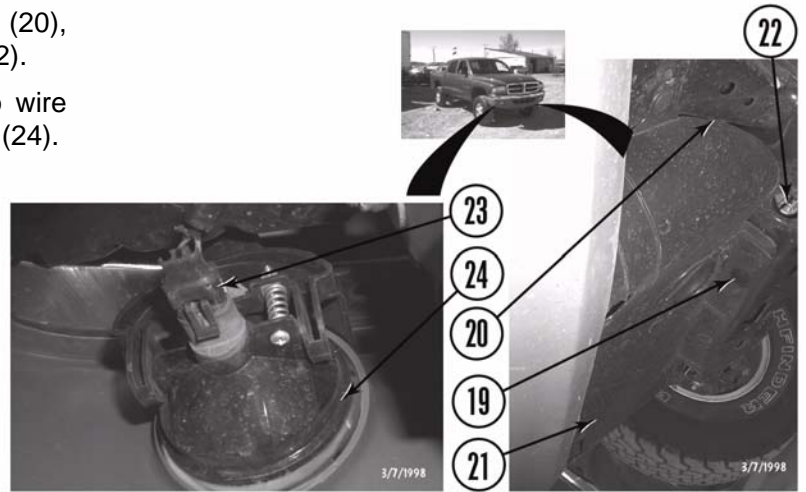

c. Remove four nuts (25), bolts (26), and two front bumper outer brackets (27) from the frame (14).

d. Remove four bolts (28) and front bumper (29) from two frame (30) inner mounts.

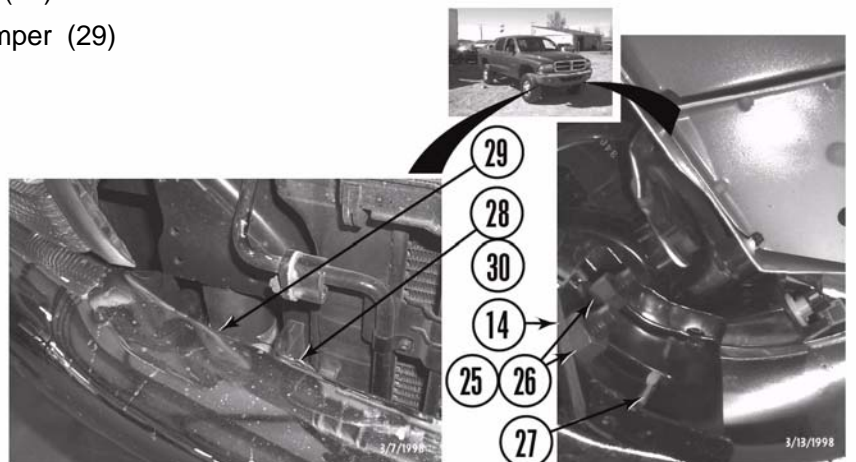

4. Remove the rear bumper.

a. Disconnect two wire harness connectors (31) from the license plate lights (32).

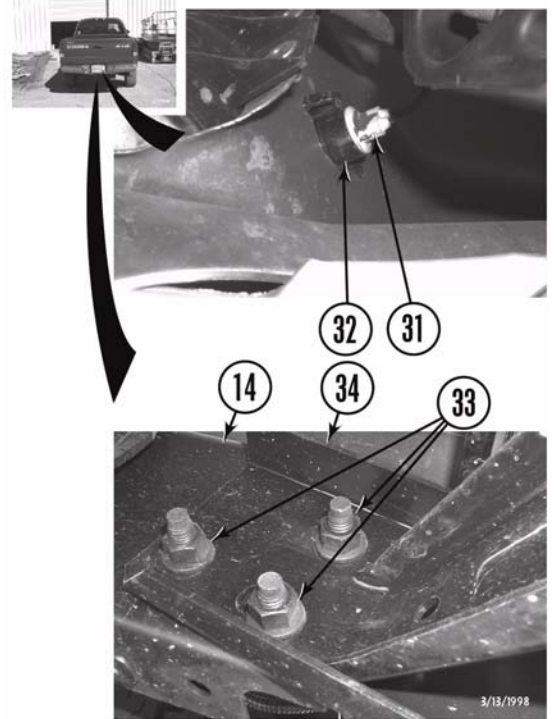

b. Remove six nuts (33) and rear bumper (34) from the frame (14).

5. Remove the fan shroud.

a. Drain the radiator (35) into a clean pan (refer to the owner's manual).

b. Remove four wire harness clips (36) and wire harness (37) from the core support (38).

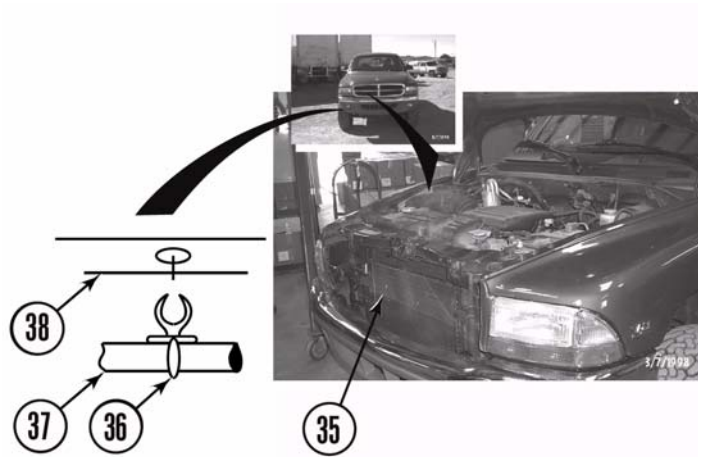

- c. Disconnect two connectors (38 and 39) and washer fluid hose (40) from the fan shroud (41).
- d. Remove four bolts (42) and the fan (43) from the water pump (44) and allow fan to rest inside the shroud.
- e. Remove four bolts (45) and fan shroud (41) from the radiator (35) and allow shroud to rest against the engine.
- f. Remove fan shroud (41) and fan (43) from the vehicle and separate upper fan shroud (41) from lower fan shroud (46).
- h. Cut the lip from the lower fan shroud (46) as shown.

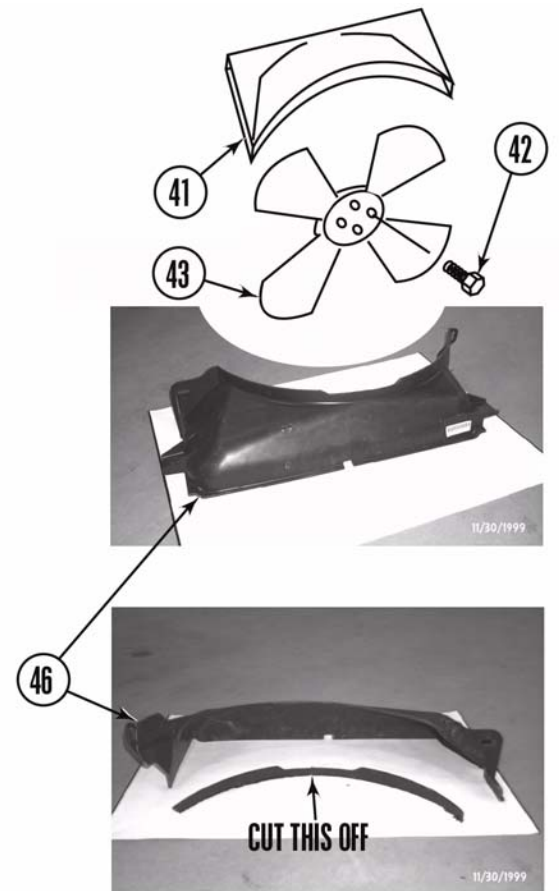
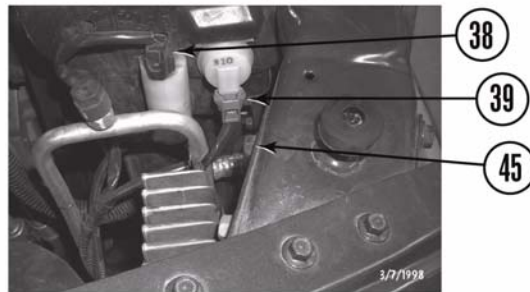
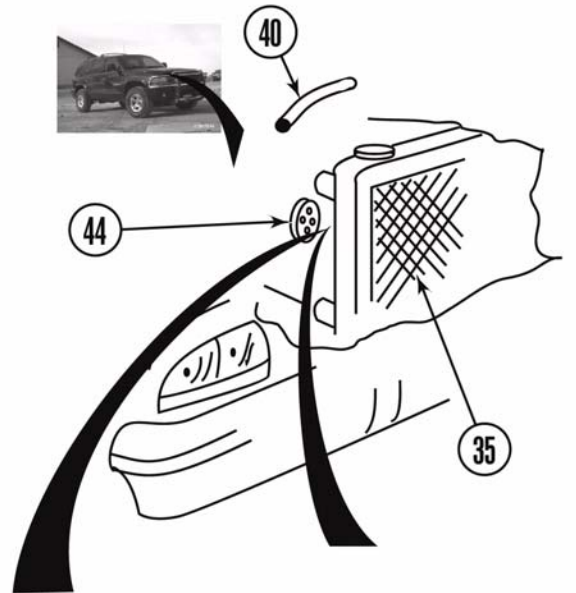

6. Remove firewall mounted ground wires.

a. Ensure two ground wires (47) on the firewall (48) have ample slack to allow for lifting. Ensure ground wire on driver's side is routed over the brake booster (49).

b. If ground wire on the driver's side is not routed over the brake booster (49), remove two nuts (50) and reroute the ground wires (47).

c. Install two ground wires (47) on the firewall (48) with two nuts (49).

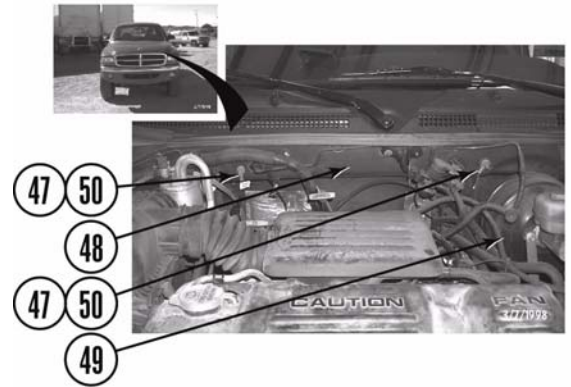

7. Driver's side frame rail.

a. Remove plastic cover (50) from driver's side front wheel well (51) and top of the frame rail (52).

b. Remove wire harness panel clip (53) from the top of the frame rail (52).

c. Remove brake lines (54) from plastic clips (55) on the frame rail (52).

d. Remove two bolts (56) and brake line bracket (57) from the frame rail (52).

e. If equipped with automatic transmission, remove automatic transmission cable (58) from the automatic transmission cable loop (59) on the driver's side front wheel well (51). Ensure cable has ample slack to allow for lifting.

f. Remove bolt (60) and loop (59) from driver's side front wheel well (51).

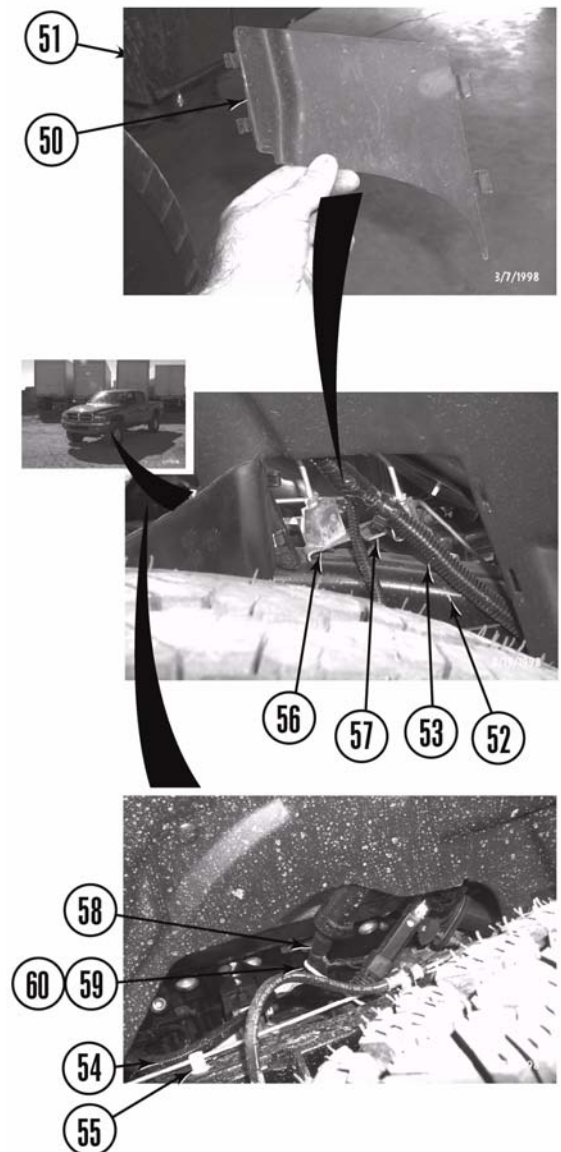

⚠ CAUTION

If the following step is not performed, the airbag clock-spring could be damaged. Do not turn the steering wheel while the steering shaft is disconnected.

Ensure steering shaft does not turn independently of the steering gearbox. This could cause the air bag system to malfunction, resulting in serious personal injury or damage to the equipment.

8. Remove steering shaft.

- a. Remove bolt (61), loosen bolt (62), and remove steering shaft (63) from top of the steering rack (64 and 65).

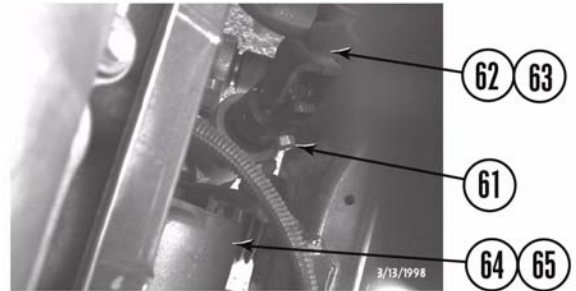
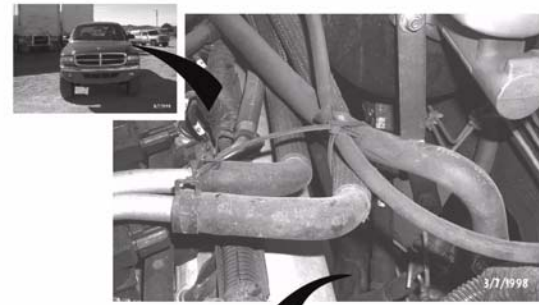

⚠ WARNING

Use extreme caution when working near the fuel lines and the fuel tank. Clean up spilled fuel immediately. A spark could cause an explosion or fire resulting in serious personal injury and property damage.

9. Remove the fuel filler hose.

- a. Remove gas cap (66). Remove three screws (67), bend two tabs (68), and let fuel filler neck (69) drop down from the bed (6).
- b. Remove two clamps (70), fuel filler hose (71), and vent hose (72) from the fuel tank (73).

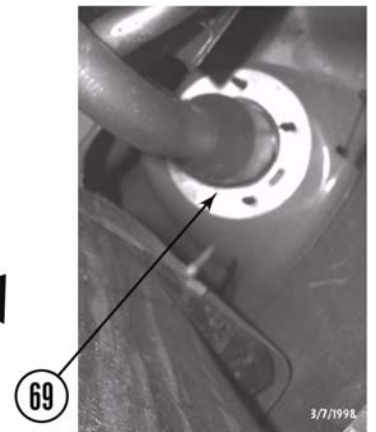
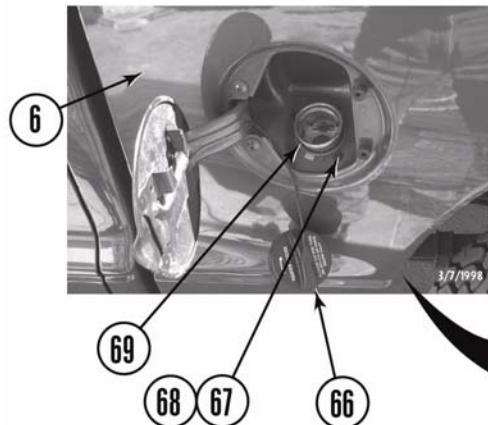
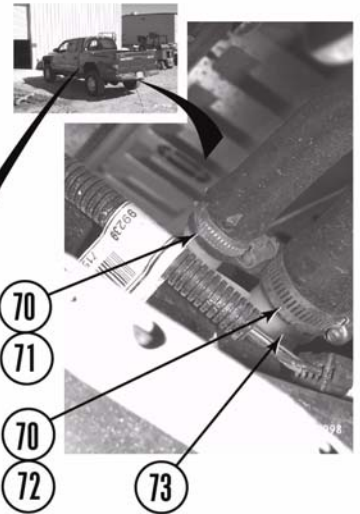

C. Install the kit.

1. Prepare to lift cab from frame.

⚠ WARNING

Use extreme caution when lifting body from frame. To prevent serious personal injury, ensure the lifting device is securely placed. Keep your hands out from between the body and frame.

- a. Measure distance between the cab (74) and the bed (6). Record measurement for later cab to bed alignment reference in the instructions.
- b. Loosen but do not remove eight cab mounting bolts (75).

⚠ CAUTION

Continually check hoses, wires, lines, etc. to be sure that everything is flexing properly and not binding, or damage to the vehicle could result. Be especially careful of the a/c hoses at the fire wall, the belt pulley, and at the core support. Ensure brake lines stretch while lifting. Bending the lines to gain ample slack may be necessary. Be extremely careful not to kink the lines.

⚠ WARNING

The **kit blocks** must be installed in addition to the factory upper and lower bushings. Installing the **kit blocks** without the factory upper and lower bushings could result in damage to the vehicle or serious personal injury.

- c. Remove bolt (76) and washer (77) from the passenger side core support frame mounting pad (78).
- d. Remove three bolts (76) and washers (77) from the passenger side frame mounting pads (78) and cab mounting pads (79).

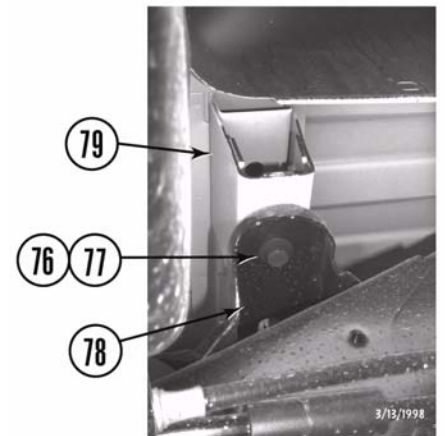
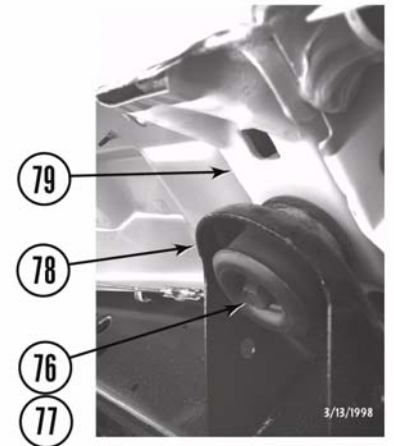
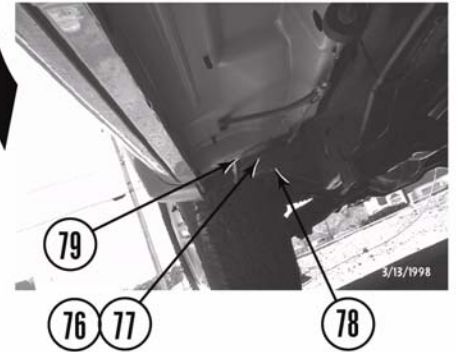
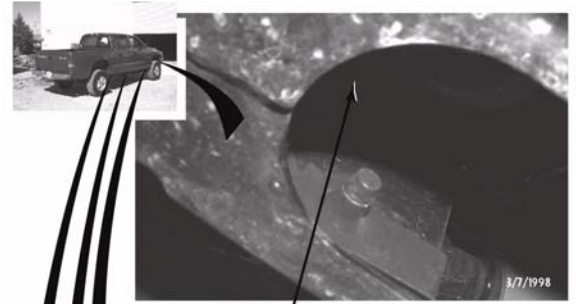

2. Lift cab and install cab passenger side spacer blocks.

a. Using a hydraulic jack and a wooden block, slowly lift the cab (74) passenger side just high enough to position the *kit* spacer blocks (80) on the frame mounting pads (78).

b. Position four *kit* spacer blocks (80) on top of the passenger side core support and frame mounting pads (78).

c. Install a *kit* 12mm x 160mm bolt (81) (12mm x 140mm for a 2" kit) and a *kit* 1/2" USS washer (82) through the bottom bushing retainer (83), bottom bushing (84), frame mounting pad (78), upper bushing (85), upper bushing retainer (86), *kit* spacer block (80), and in the body mounting pad (87). Do not tighten.

d. Lower cab (74) on the *kit* spacer blocks (80).

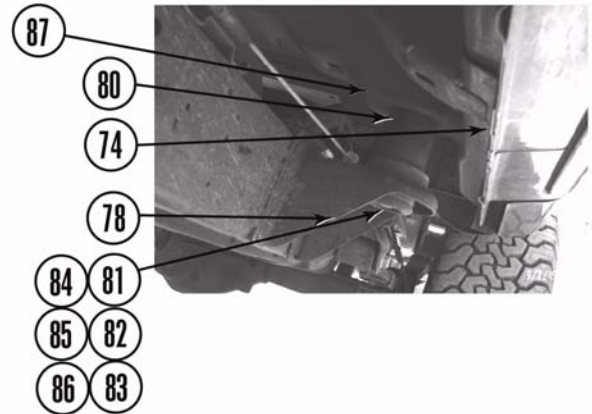
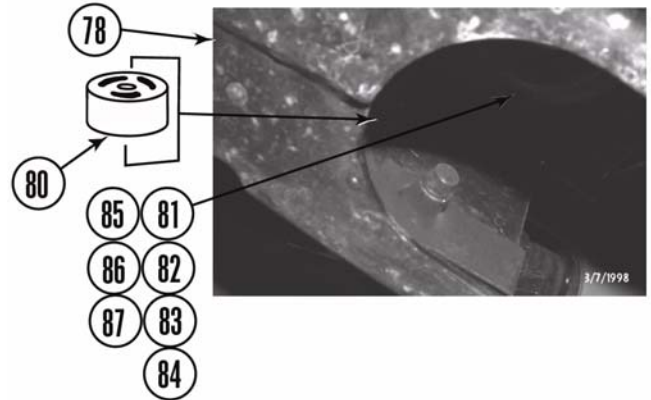

3. Install the cab driver's side spacer blocks.

a. Repeat steps C. 2. a. through d. for the cab driver's side.

4. Finish the cab spacer block installation.

a. Adjust cab to bed clearance using the measurements from step C. 1. a.

b. Remove eight bolts (81) one at a time, coat threads with Loctite®, and reinstall. Tighten to 55 lb-ft.

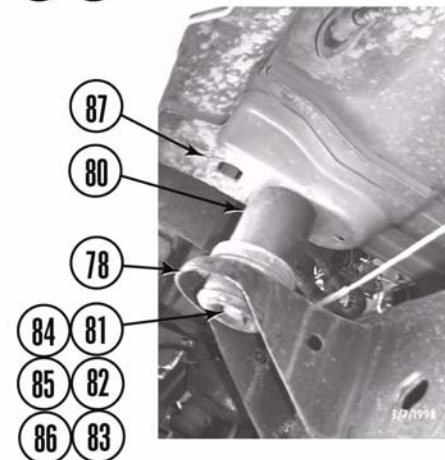
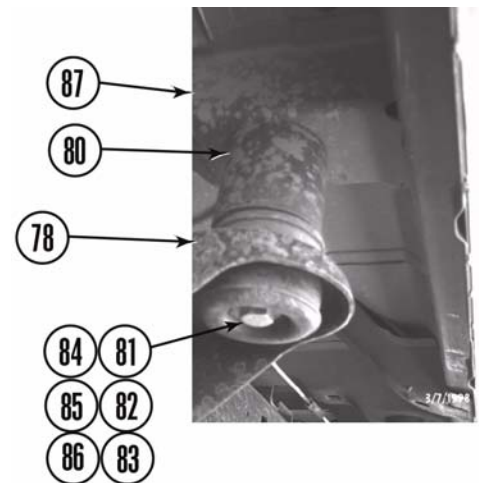

5. Install the bed passenger's side spacer blocks.

a. Loosen but do not remove eight bed mounting bolts (88).

b. Remove four bolts (88) from the bed (6) passenger side.

c. Using a hydraulic jack and a wooden block, slowly lift the bed (6) passenger side just high enough to position the *kit* spacer blocks (89 and 90) on the frame (14). The small spacer blocks (90) go on the rearmost mounts.

d. Install a *kit* 10mm x 100mm bolt (91) (10mm x 80mm for a 2" kit), a *kit* 7/16" USS washer (92), and a *kit* 3/8" washer (93) through the frame mounting pad (78), *kit* spacer block (89 or 90), and in the bed mounting pad (94). Do not tighten.

e. Lower the bed onto the spacer blocks (89 and 90).

6. Install the bed driver's side spacer blocks.

a. Repeat steps C. 5 a. through e. for the bed driver's side.

7. Finish the bed spacer block installation.

a. Adjust the cab to bed clearance using the measurements from step C. 1. a.

b. Remove eight bed mounting bolts (91) one at a time, coat threads with Loctite®, and reinstall. Tighten to 55 lb-ft.

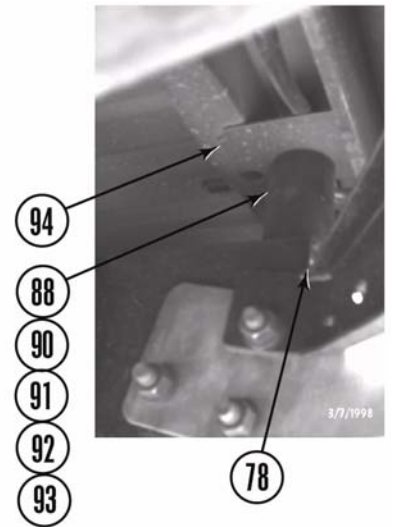
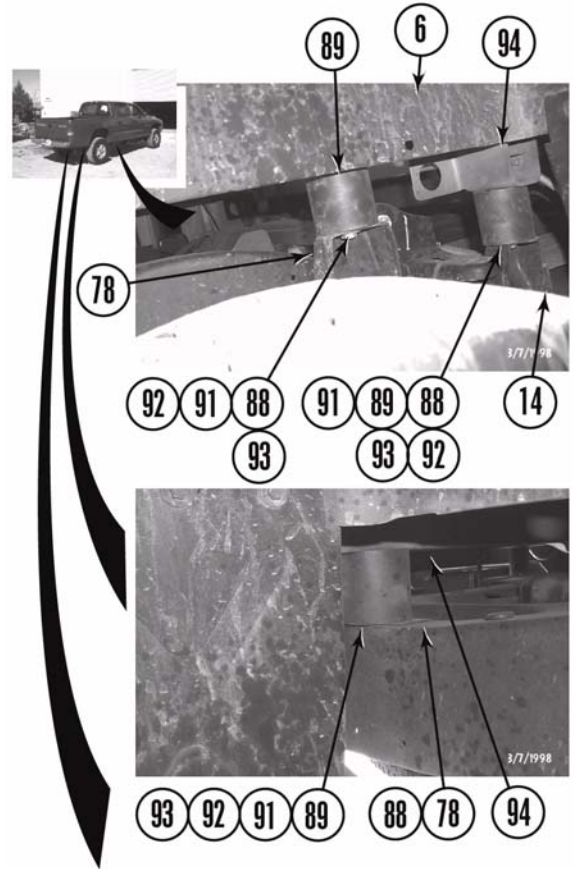

⚠ WARNING

Use extreme caution when working near the fuel lines and the fuel tank. Clean up spilled fuel immediately. A spark could cause an explosion or fire resulting in serious personal injury and property damage.

8. Install the fuel filler hose.
 - a. Install fuel filler hose (71) and vent hose (72) on fuel tank (73) with two clamps (70).
 - b. Position fuel filler neck (69) in bed (6), straighten tabs (68), and install three screws (67). Bend tabs over screws. Install gas cap (66).

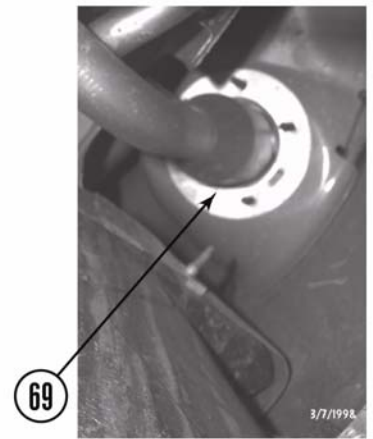
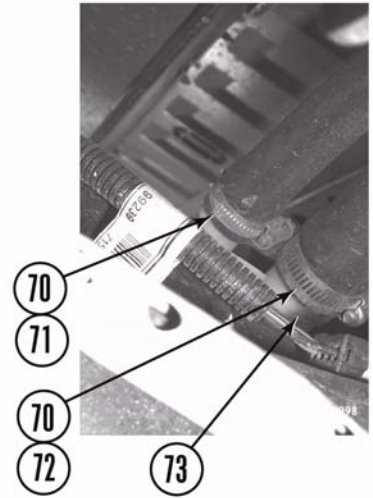
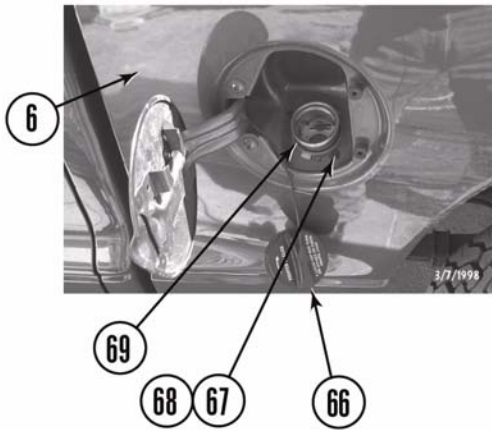

9. Install *kit* steering extension.

⚠ WARNING

Verify the steering extension is securely installed as specified in the instructions. Failure to do so may cause steering malfunction, resulting in property damage or serious personal injury.

- a. Coat threads of retaining bolts (61, 62, and 95) with Loctite®.
- b. Install *kit* steering extension (96) on steering rack (64 and 65) with the *kit* retaining bolt (95). Do not tighten.
- c. Install steering shaft (63) on *kit* steering extension (96 or 97) with the stock retaining bolt (61).
- d. Tighten bolts (61, 62, and 95) to 20 lb-ft.

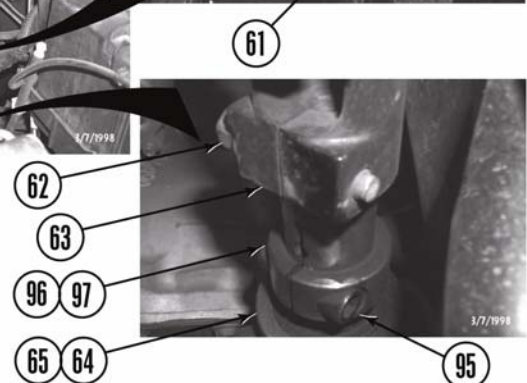
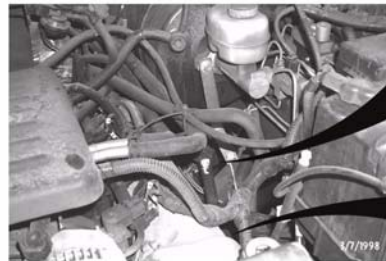

10. Install the fan shroud.

- a. Remove two clamps (98) and lower radiator hose (99). Turn hose 180 degrees and reinstall.
- b. Join upper fan shroud (41) and lower fan shroud (46).
- c. Position fan (43) and fan shroud (41) in the vehicle.
- d. Install fan shroud (41) on the radiator (35) with four bolts (45). Do not tighten.
- e. Install fan (43) on the water pump (44) with four bolts (42).
- f. Adjust fan to fan shroud and fan to hose clearance. Ensure fan cannot contact hoses or the fan shroud. Tighten four bolts (45).
- g. If lower radiator hose (99) appears to be too close to fan (43), cut hose and install hose extension (99a) with two *kit* clamps (99b).
- h. Connect washer fluid hose (40) and two connectors (38 and 39) on the fan shroud (41).
- i. Fill radiator (35) (refer to the owner's manual)

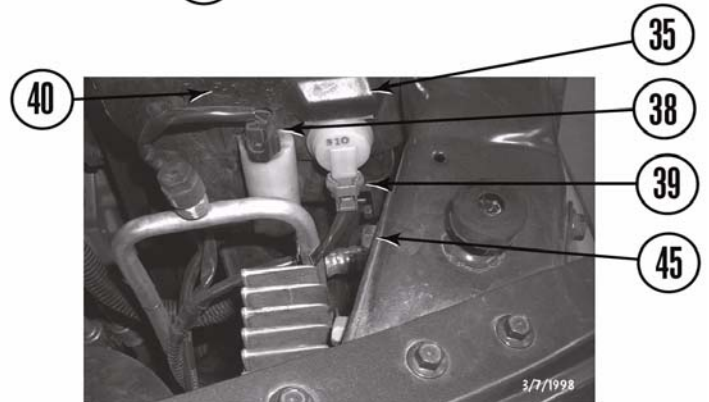
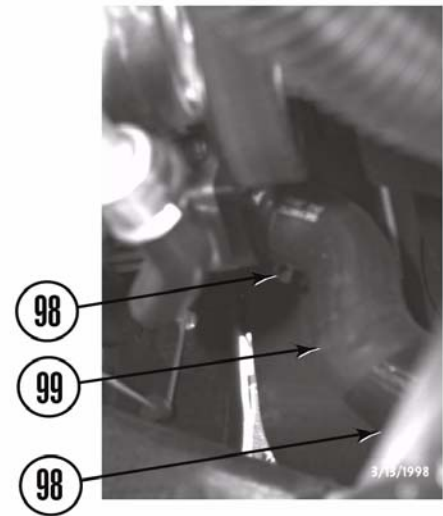
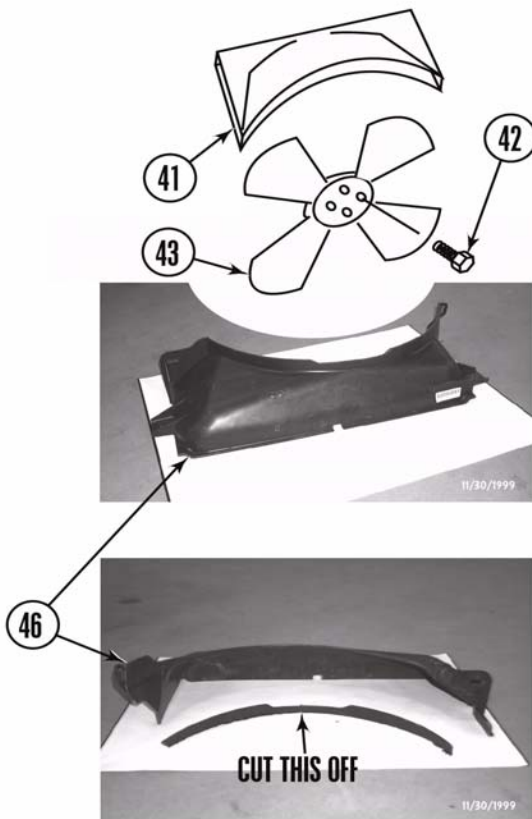
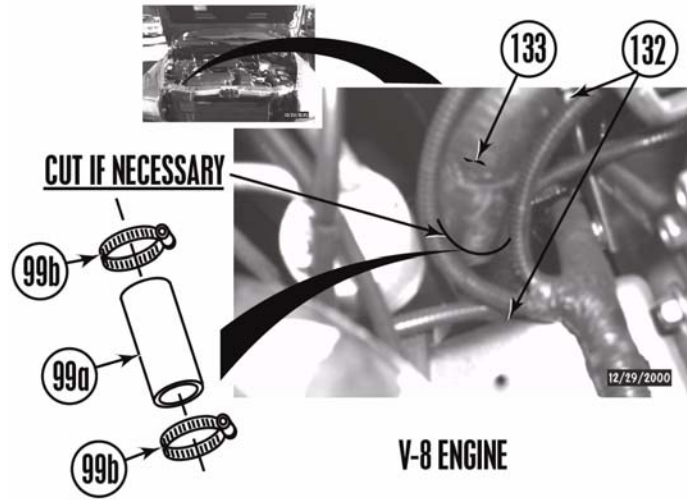

i. Install four wire harness clips (36) in core support (22) holes where possible.

j. Use *kit* zip ties (100) to secure wire harness (37) to the a/c lines (101).

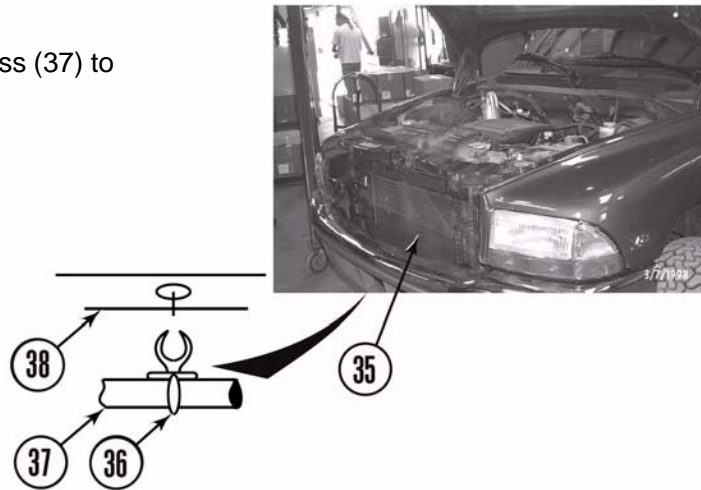

11. Check battery positive cable (8) length. If positive cable is not long enough to reach the battery (9):

a. Remove bolt (102) and cable (8) from frame rail (52).

b. Install *kit* extension strap (103) on frame rail (52) with bolt (102).

c. Install cable (8) on *kit* extension strap (103) with *kit* bolt (104), lock washer (105), and nut (106).

d. Strap cable (8) to the power steering hose (107) with *kit* zip tie (108).

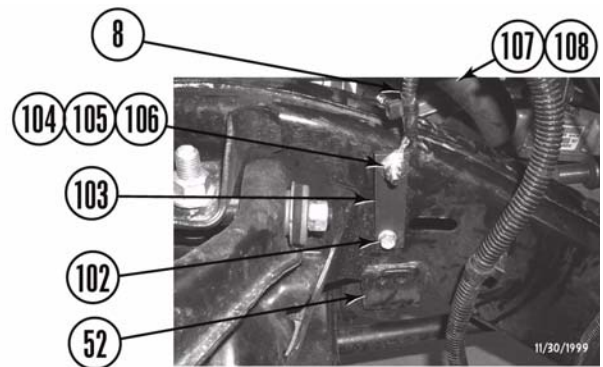
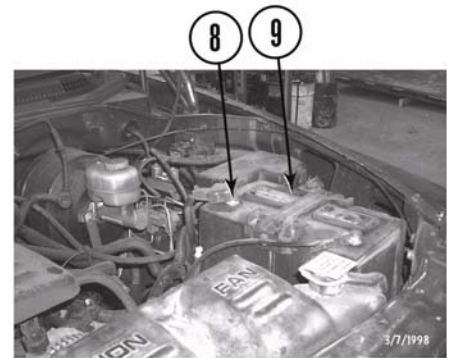

12. Install the front bumper.

a. Coat threads of bolts (26, 28, 111, and 114) with Loctite®.

b. Install two *kit* inner front bumper brackets (109) on frame (14) inner mounts with four bolts (28) (the “C” should open to the rear of the vehicle). Center brackets on mounts and tighten bolts to 55 lb-ft.

c. Install two *kit* outer brackets (110) on the frame (14) with four bolts (26) and nuts (25). Do not tighten.

d. Install front bumper (29) on two *kit* inner brackets (109) with four *kit* 7/16” x 1 1/2” bolts (111), eight 7/16” USS washers (112), and four 7/16” nylock nuts (113). Insert bolts with heads facing center of vehicle. Do not tighten.

e. Install front bumper (29) outer brackets (27) on two *kit* outer brackets (110) with four 7/16” x 1” bolts (114), eight 7/16” USS washers (115), and four 7/16” nylock nuts (116). Insert bolts with heads facing center of vehicle. Do not tighten.

f. Adjust bumper to body clearance and tighten bolts (26, 28, 111, and 114) to 55 lb-ft.

g. If removed, connect two wire harness connectors (23) on driving lights (24).

h. Install rubber cover (21) and plastic cover (20) on core support (22) with nine panel clips (19).

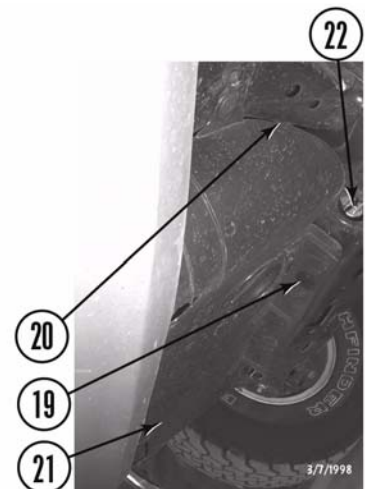
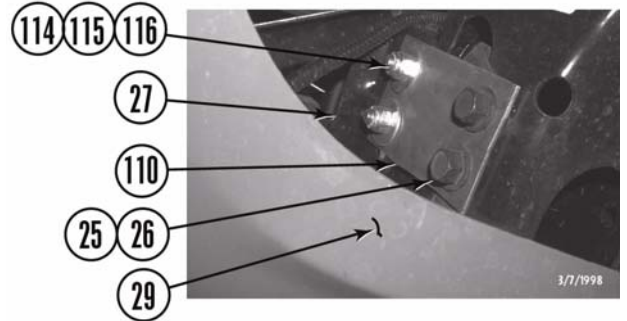
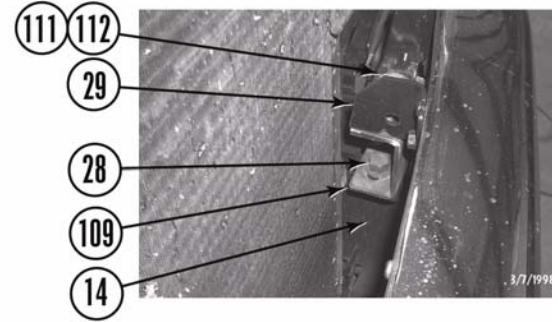

13. Install the rear bumper.

⚠ WARNING

The following procedure is intended only to enhance the appearance of the vehicle. The rear bumper will no longer be rated for towing of any kind. Towing with the rear bumper after it has been lifted can result in death, serious personal injury, or damage to the vehicle. Towing after the bumper has been lifted should be accomplished using a rated Class III receiver type hitch.

- a. Coat threads of nuts (33) with Loctite®.
- b. Install two *kit* brackets (117) on frame (14) with six nuts (33).
- c. Install rear bumper (34) on *kit* brackets (117) with four nuts (33). Do not tighten.
- f. Adjust bumper to body clearance and tighten nuts (33) to 55 lb-ft.

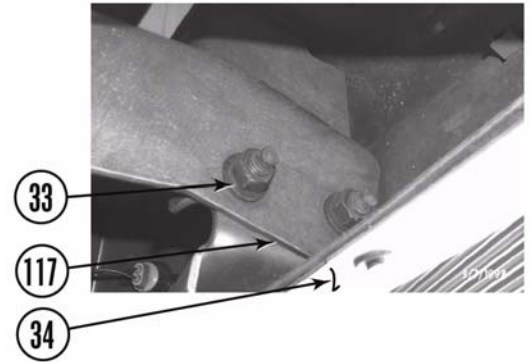
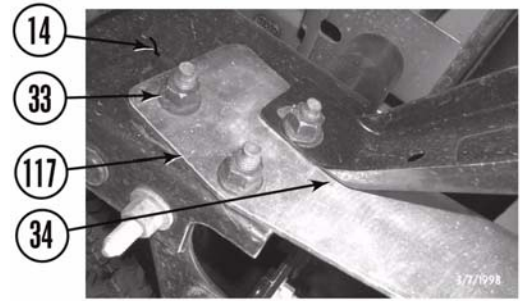

- g. Connect two wire harness connectors (31) on license plate lights (32).

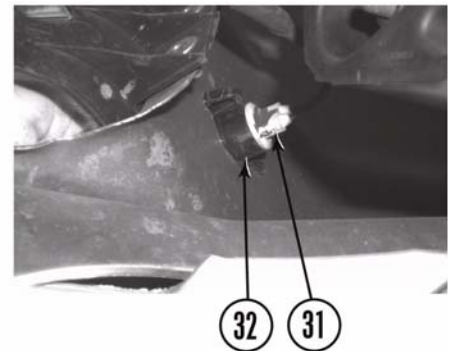

14. Install brake lines.

⚠CAUTION

Ensure brake lines stretch while lifting. Bending the lines to gain ample slack may be necessary. Be extremely careful not to kink the lines.

- a. Check brake lines (54) removed from clips (55) on the driver's side frame rail (52). If necessary, carefully straighten lines to gain more slack.
- b. Install *kit* bracket (118) on frame rail (52) with bolt (56).
- c. Install brake line bracket (57) on *kit* bracket (118) with *kit* 5/16" bolt (119), three *kit* 5/16" washers (120) and *kit* 5/16" nylock nut (120).
- d. Install plastic clip (55) on bracket (57).
- e. Install brake lines (54) in the plastic clips (55).

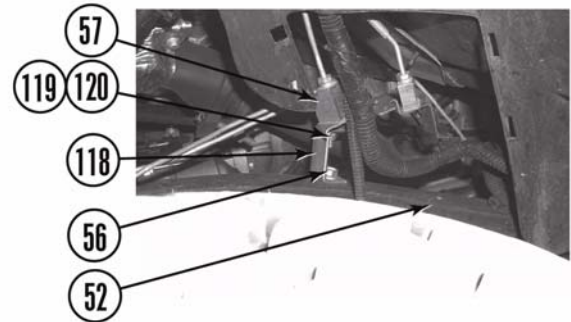
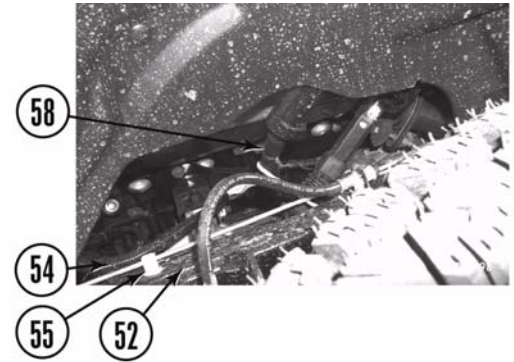

15. Reposition automatic transmission shift cable.

- a. Install *kit* bracket (121) and automatic transmission cable loop (59) on the brake booster (49) with two *kit* 1/4"x1" bolts (122), three *kit* 1/4" washers (123), and a *kit* 8mm nylock nut (124).
- b. Position automatic transmission cable (58) in the automatic transmission cable loop (59).

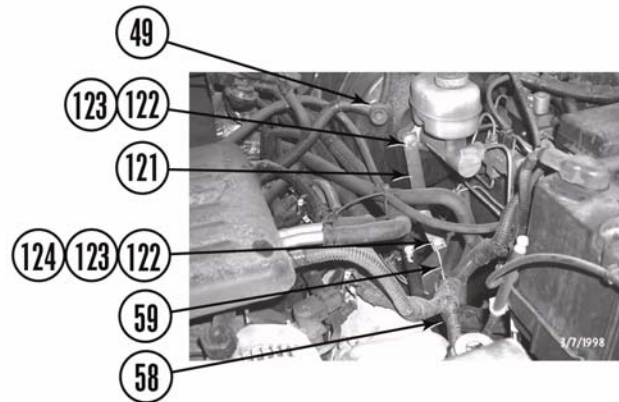

⚠ WARNING

A certified welder or welding shop should perform all welding.

16. Lengthen and install the transfer case shift linkage.

- a. Position 4WD shifter in neutral. Measure distance center to center between holes in (17) and (18).
- b. Measure length of linkage rod (16) and add 3" for *kit* linkage extension (125). If total length of (16) and (125) is greater than distance between (17) and (18), shorten *kit* linkage extension (125) so measurements are equal.
- c. Scribe a line along the transfer case linkage rod (16). Cut linkage into two pieces through line.
- d. Position *kit* linkage extension (125) between two pieces of the linkage rod (16), align two halves of scribed line, and weld extension in place.
- e. Install transfer case shift linkage (16) on shift lever (17) and transfer case (18) with two rubber bushings (15).
- f. If removed, install skid plate (13) on the frame (14) with four bolts (12).

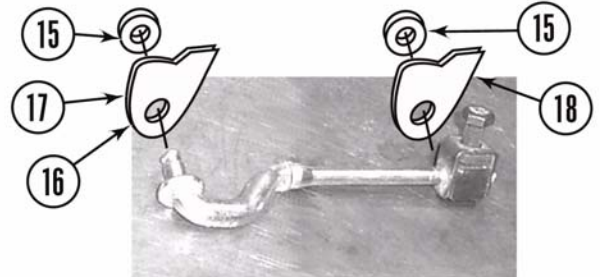
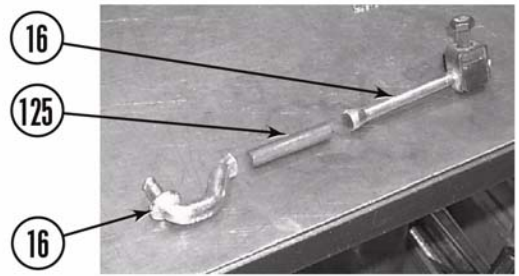

17. Manual Transmission Models: Shift Lever

- a. Scribe a line along side of transmission shift lever below bend as shown. Cut lever into two pieces through line and de-burr as necessary.

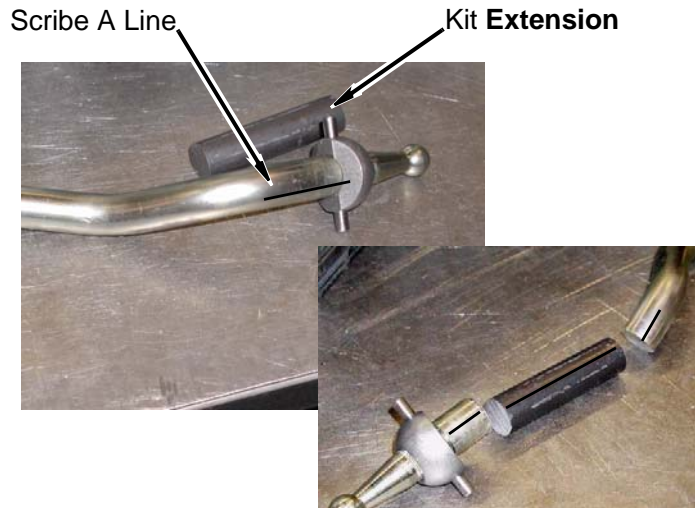

b. Position kit **extension** transmission shift lever 5/8" x 3" between two pieces of transmission shift lever. Ensure kit **extension** and shift lever scribe lines align and weld extension in place. Let shift lever cool.

c. Install insulator, two pivot pins, washer, and locking plate on modified lower shift lever. Position modified lower shift lever in shift tower.

d. Install locking plate with four screws and dust cover on shift tower.

e. Install lower shift boot on cab floor with six screws. Install shift console on cab floor with six screws.

f. Install upper shift lever on modified lower shift lever. Install upper shift boot on shift console with six screws.

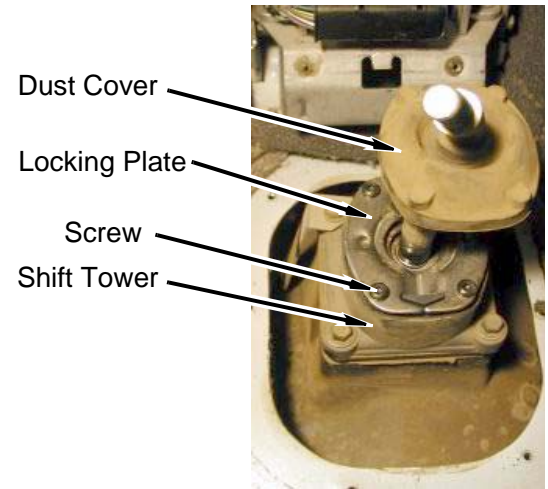

Lower Shift Boot



Shift Console

18. Tack weld two *kit* bed overload spacers (126) on the frame (14) over the rear wheel wells (127) as shown.

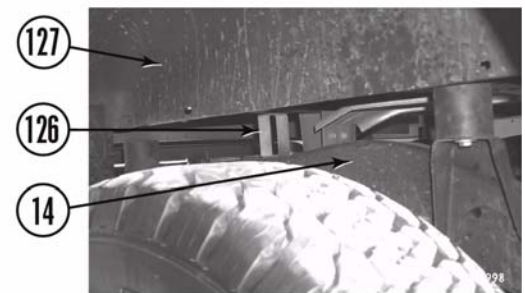

D. After installation is complete.

1. Install two airbag fuses (10) in the fuse box (11).
2. Install battery (9) and connect both battery cables. Be sure to reconnect the positive cable (8) first, then the negative cable (9).

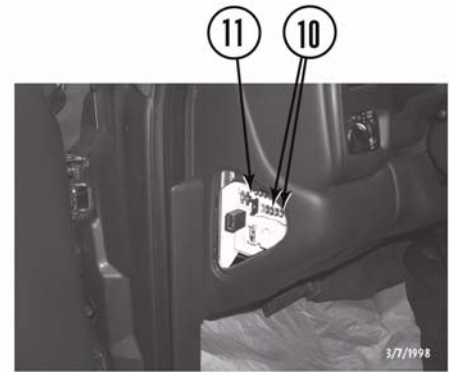
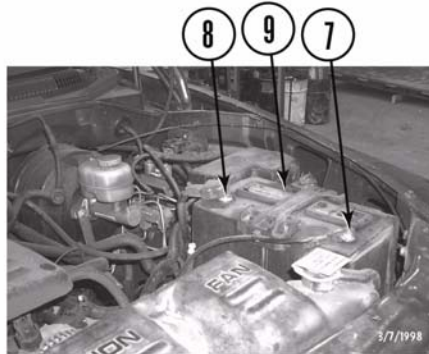

3. Install the spare tire (1).

a. To remount crank rod (3) on vehicle, drill a 5/16" hole in the crossmember (128) as shown.

b. Install *kit* clamp (129) with *kit* 1/4" x 1" bolt (130), *kit* 1/4" washer (131), and *kit* 1/4" nylock nut (132). Ensure bolt is installed up toward bed.

c. Install crank rod (3) in *kit* clamp (129).

d. Remove license plate and drill 3/4" hole in plastic part of rear bumper (34) as shown. Install plastic collar (5). Ensure you can successfully lower crank rod (3) through hole. Reinstall license plate.

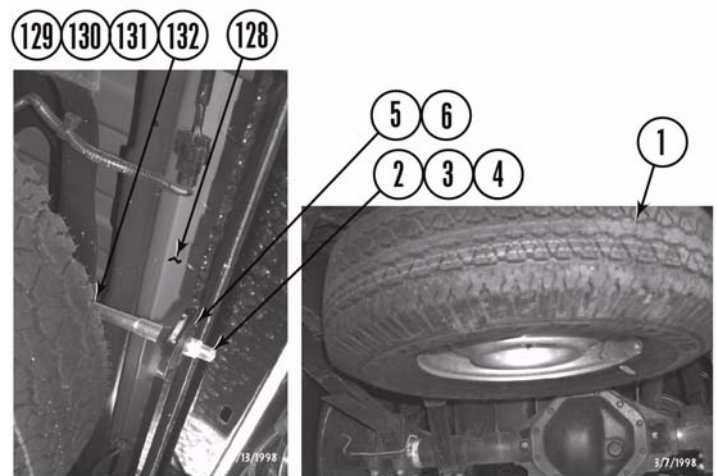

4. Apply *kit* warning sticker on the dash in plain sight of all vehicle occupants.

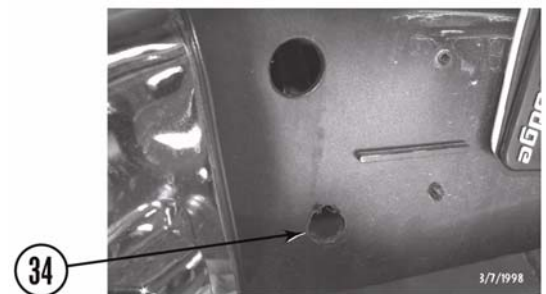

5. Double check the vehicle.

⚠WARNING

Retorque all fasteners after 500 miles and after off road use. All body lift components should be visually inspected and fasteners retorqued during routine vehicle servicing.

- a. Check all mounting hardware to ensure it is properly tightened.
- b. Check all wires, hoses, cables, etc. to ensure they have been properly connected and there is ample slack. With the number of hoses on this vehicle, it is vital that this be checked thoroughly.
- c. Check vehicle electrical system.
- d. Start vehicle and check the steering in both directions to ensure that there is no bind. Check clutch operation. Check the operation of the brake system and the parking brake. Check both shift levers' operation. Ensure that there is proper engagement in all gears and 4 wheel drive ranges.

⚠WARNING

If the engine cooling system is hot, the coolant will be HOT and UNDER PRESSURE. To prevent serious personal injury, wait until the cooling system is completely cool before removing the cap from the radiator.

- e. Check coolant level. Fill coolant to the proper level (refer to the Owner's Manual).
- f. Test drive vehicle in all gears and 4 wheel drive ranges. Pay close attention to all vehicle systems. Check all hardware again in 500 miles and as part of your regular maintenance schedule.
- g. Adjust headlights.

⚠CAUTION

Performance Automotive Group does not recommend any particular wheel and tire combinations for use with its body lifts and cannot assume responsibility for the customer's choice of wheels and tires. Refer to your owner's manual for recommended tire sizes and warnings related to the use of oversized tires. Larger wheel and tire combinations increase stress and wear on steering and suspension components, which leads to increased maintenance and higher risk for component failure. Larger wheel and tire combinations also alter speedometer calibration, braking effectiveness, center of gravity, and handling characteristics. Consult an experienced local off road shop to find what wheel and tire combinations work best with your vehicle.

NOTE

All warranty information, instruction sheets, and other documents regarding the installation of this product must be retained by the vehicle owner. Information contained in the instructions and on the warranty card will be required for any warranty claims. The vehicle owner needs to understand the modifications made to the vehicle and how they affect vehicle handling and performance. Failure to provide the customer with this information can result in damage to the vehicle and severe personal injury.

Accessories

Kit# 6617 Gap Guards

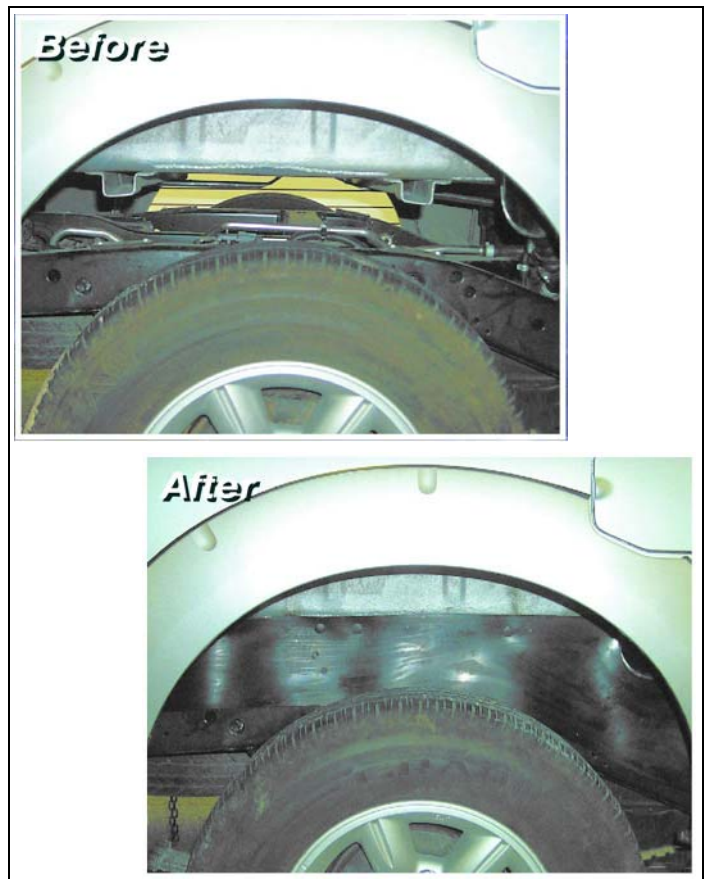

E. Kit Parts List.

Qty	Description
-----	-------------

12	3 x 3 blocks
2	3 x 2 blocks
2	Front inner bumper brackets
2	Front outer bumper brackets
2	Rear bumper brackets
1	Brake line bracket
1	Transmission cable bracket
2	Overload spacers, no hole
1	Warning to driver sticker
1	Logo sticker
1	6ml bottle Loctite



Front bumper inner bracket

1	Bolt pack BP60043
8	12mm x 160mm bolts
8	10mm x 100mm bolts
8	1/2" USS washers
8	7/16" USS washers
1	se 8700 steering extension
1	3/8" x 1 1/4" socket head bolt



Front bumper outer bracket

1	Hardware pack HP60043
----------	------------------------------

Bolts

4	7/16" x 1 1/2" bolts
4	7/16" x 1" bolts
1	5/16" x 1" bolt
4	1/4" x 1" bolts

Washers

6	7/16" USS washers
3	5/16" SAE washers
5	1/4" SAE washers

Nuts

8	7/16" nylock nuts
1	5/16" nylock nuts
2	1/4" nylock nut
1	8mm nylock nut

Miscellaneous

1	Transfer case linkage rod extension (1/2" x 3")
1	Manual shift lever extension (5/8" x 3")
1	Lower radiator hose extension
1	Ground strap extensions
1	Rubber clad clamp
3	Zip ties
2	#36 clamps



Rear bumper bracket