



3651 N. Hwy 89
Chino Valley, AZ 86323
(928) 636-7080 • www.p-a-g.net

1997-2003 CHEVY S-10 BLAZER INSTALLATION INSTRUCTIONS KIT #152

⚠WARNING

Installation of a Performance Accessories body lift will change the center of gravity and the handling characteristics of the vehicle. Because of the higher center of gravity and larger tires, the vehicle will handle and react differently both on and off road. You must drive it safely! Extreme care must be taken to prevent vehicle rollover or loss of control, which could result in serious injury or death. Avoid sudden sharp turns or abrupt maneuvers and always make sure all vehicle occupants have their seat belts fastened.

⚠WARNING

Read and understand all instructions, warnings, cautions, and notes in this sheet and in your owners manual before you begin the installation of this body lift kit.

⚠CAUTION

Proper installation of a Performance Accessories body lift kit requires knowledge of the factory recommended procedures for disassembly and assembly of original equipment components. We recommend that the factory shop manual and any special tools necessary to your vehicle be on hand during the installation. Installation of this body lift kit without proper knowledge of the factory recommended procedures may affect the performance of these components and the safety of your vehicle. We strongly recommend that a certified mechanic familiar with the installation of similar components install this body lift kit.

⚠WARNING

This body lift kit should only be installed on vehicles in good working condition. Before installation, the vehicle should be thoroughly inspected for evidence of corrosion or deformation of the sheet metal around the factory body mounts. This body lift kit should not be installed on any vehicle that is suspected to have been in a collision or misused. Off road use of your vehicle with this body lift installed may increase the stress applied to the factory body mounts. We do not recommend that any vehicle with a body lift installed be involved in any extreme off road maneuvers such as jumping. Failure to observe this warning may result in serious personal injury and/or severe damage to your vehicle.

⚠WARNING

Performance Accessories strongly discourages the use of a suspension lift kit or any other lift device in addition to a body lift kit. A vehicle that uses a combination of lift devices not originally engineered to be used together may result in unexpected and unsafe handling characteristics. Many states now have laws restricting bumper heights and vehicle lifts. Local laws should be consulted to determine if the changes you intend to make to your vehicle comply with state laws.

⚠WARNING

The installation of larger wheel and tire combinations may reduce the effectiveness of the Anti-lock Braking System.

⚠WARNING

Always wear eye protection when operating power tools.

⚠WARNING

Ensure that your vehicle tires are properly blocked and secured before you begin installation of this lift kit.

⚠WARNING

The Supplemental Restraint System (SRS, or air bag) must be deactivated during lift kit installation to avoid accidental air bag deployment while working near SRS sensors and wiring. Do not allow anyone near the air bag during lift kit installation. Accidental deployment can result in serious personal injury or death. Refer to your factory service manual/owner's manual for the recommended procedure to disable the SRS. The SRS must be reactivated before driving the vehicle.

⚠NOTE

Performance Accessories recommends using the Loctite® supplied in the kit on all hardware unless noted in the instructions.

A. Before you start.

⚠NOTE

As you read through this procedure, note that each part referenced has the same callout number throughout. Also, the part number in the text matches the corresponding part number in the art. Kit parts are prefaced by the word *kit* in italics.

⚠NOTE

You will find it easier to keep track of hardware if immediately after removal you put the fasteners for each subassembly in a paper lunch bag and write on the bag where they go.

1. Read all warnings and instructions completely and carefully before you begin.
2. Check to make sure the kit is complete (refer to the Parts List, section E).
3. Only install this kit on the vehicle for which it is intended. If anytime during the installation you encounter something different from what is outlined in the instructions, call technical support at (928) 636-0979.
4. Park the vehicle on a clean, dry, flat, level surface and block the tires so the vehicle cannot roll in either direction.
5. Disconnect both battery cables. Disconnect the negative cable (1) first, then the positive cable (2) from the battery (3).

⚠NOTE

Fuse locations may vary. Check fuse chart on back of cover.

6. Remove cover (4) and airbag "SIR" fuse (5) from fuse panel (6).

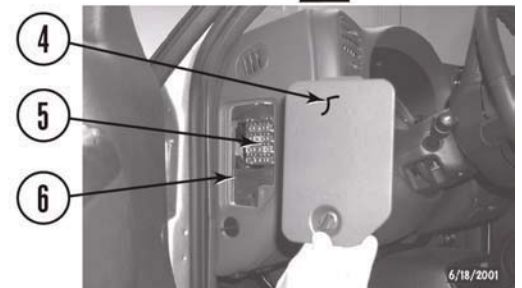
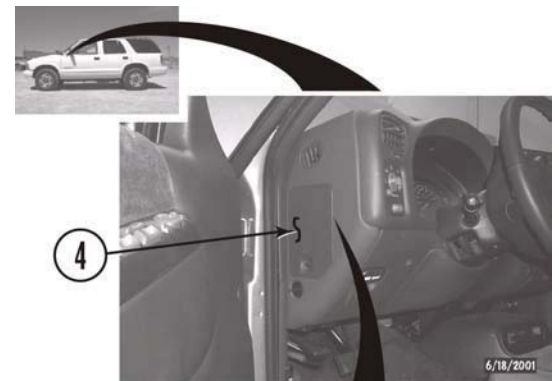
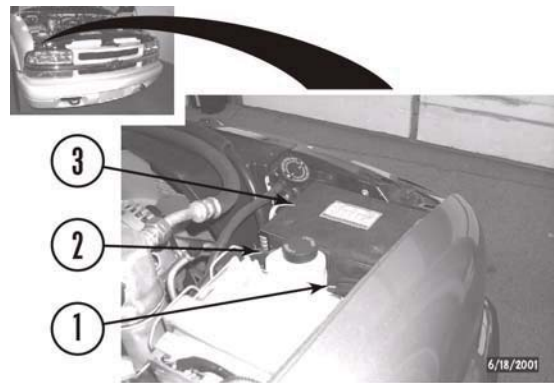

B. Get ready to install the kit.

1. Remove the grille.

- a. Remove ten pull clips (7) and grille (8) from core support (9).
- b. Remove two turn signal lamps (10) from turn signal housings (11).
- c. If so equipped, remove two wire harness connectors (12) from running lights (13). Remove grille from vehicle.

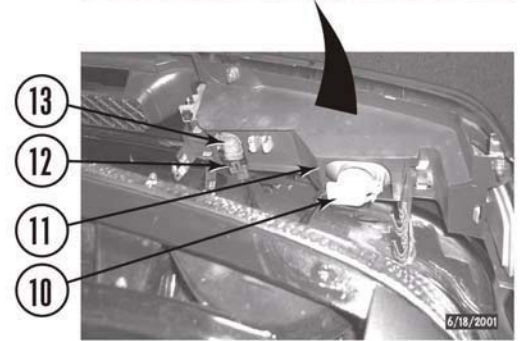
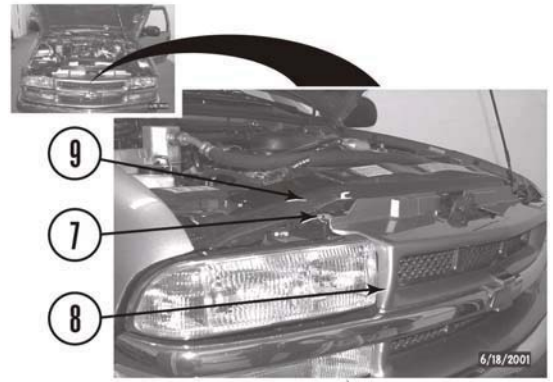

2. Remove the front bumper.

- a. Measure distance between the front bumper (14) and front fenders (15). Record measurement.
- b. Loosen two bolts (16) from front bumper side brackets (17) and front bumper (14).
- c. Remove four bolts (18) from front bumper side brackets (17) and frame (19).

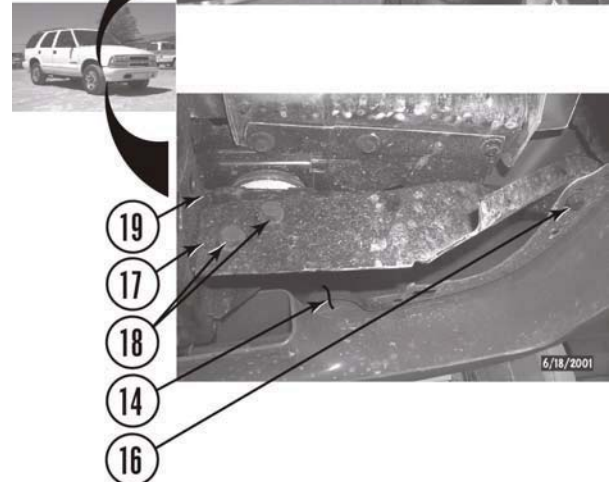
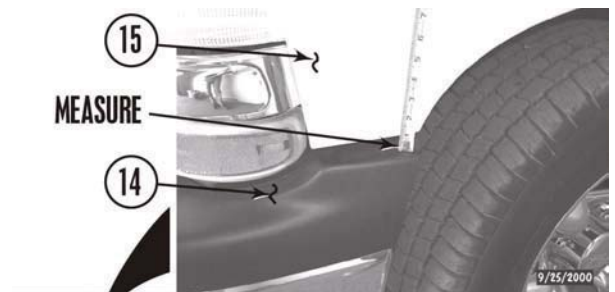

- d. Remove four bolts (20) and front bumper (14) from frame (19).

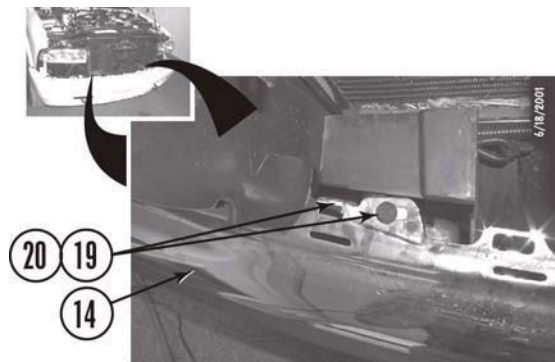

- e. Remove four pull clips (21) and plastic air scoop (22) from core support (9).

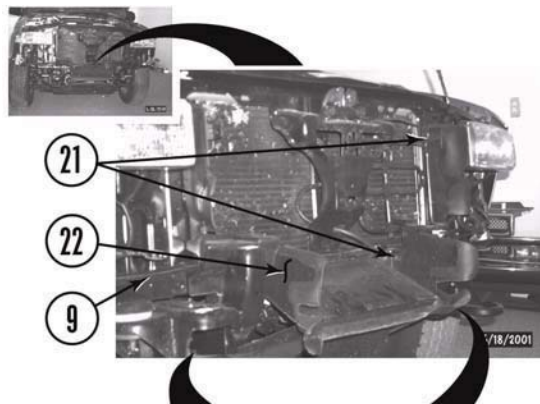

- f. Remove four bolts (23) and two tow hooks (24) from frame (19).

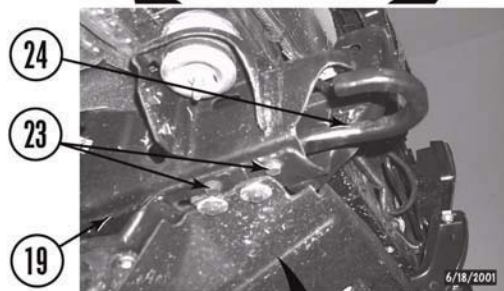

- g. Remove six bolts (25), washers (26), and plastic cover (27) from frame (19).

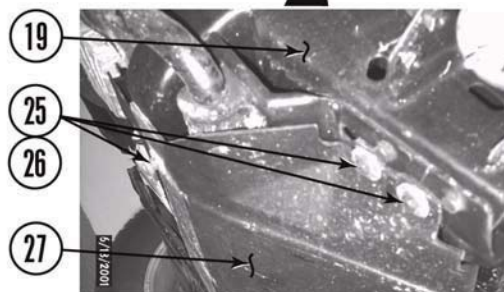

- h. Remove two shoulder bolts (28) and oil filter bracket (29) from core support (9).



3. Under the hood.

a. **Four cylinder only** (not pictured) - Remove two clamps and two flexible air duct hoses from air duct on top of radiator. Remove air duct from radiator by pulling straight up on duct.

b. Remove vent hose (30) from clip (31) and upper fan shroud (32).

c. Remove seven bolts (33) and upper fan shroud (32) from core support (9), and lower fan shroud (34).

d. Pull up on lower fan shroud (34) and remove from three clips on bottom of radiator (35). Let lower fan shroud rest under fan.

e. Remove nut (36) and battery hold down (37) from battery tray (38). Remove battery (3) from vehicle.

f. On vehicles equipped with electrical ground strap (39) attached to frame (19), remove bolt (40) and ground strap from frame.

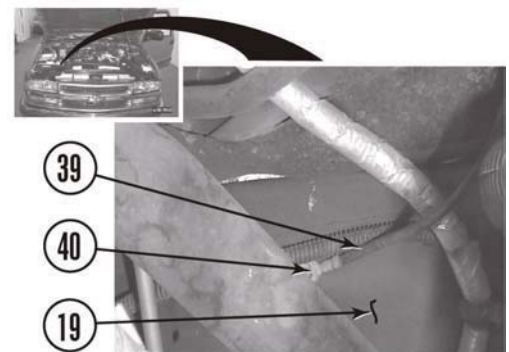
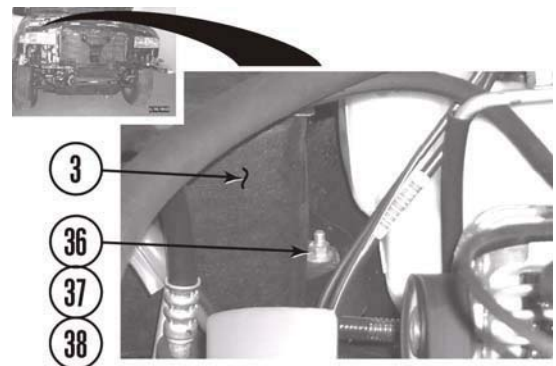
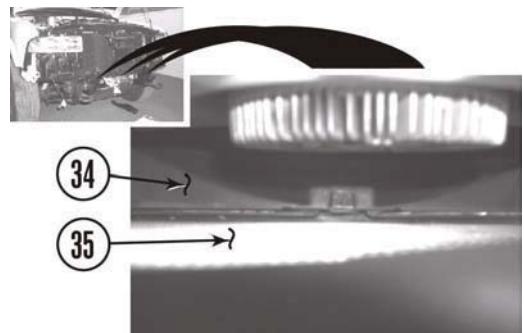
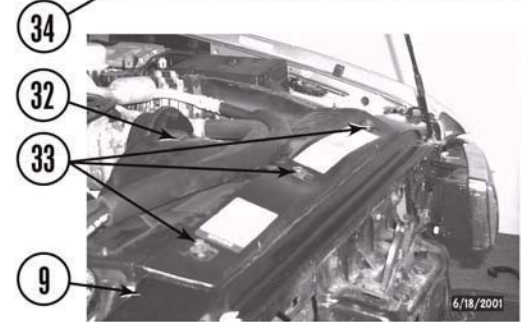
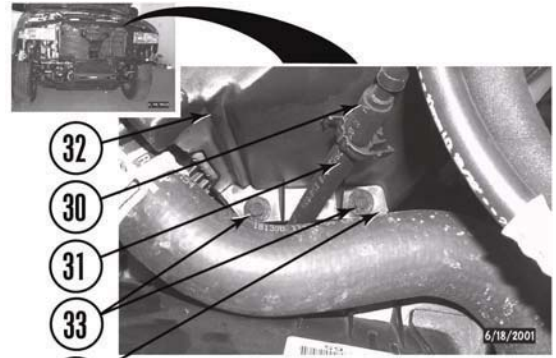

- g. Remove two bolts with captive washers (41) and battery tray (38) from core support (9).

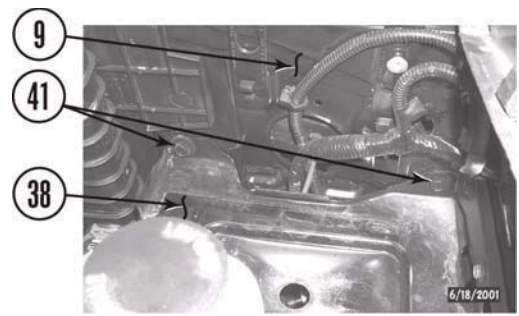

- h. Remove clip (42) and positive cable terminal box (43) from bracket (44).

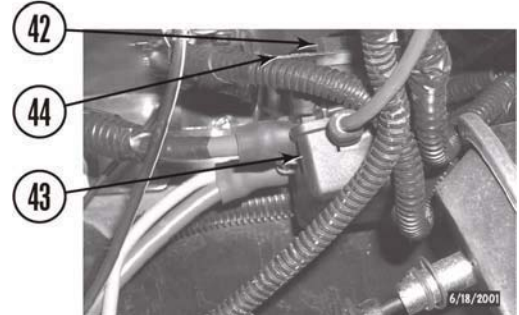

- i. Remove two sheet metal screws (45) and bracket (44) from core support (9).

- j. Remove two bolts with captive washers (46), differential actuator (47), and bracket (48) from passenger side wheel well (49).

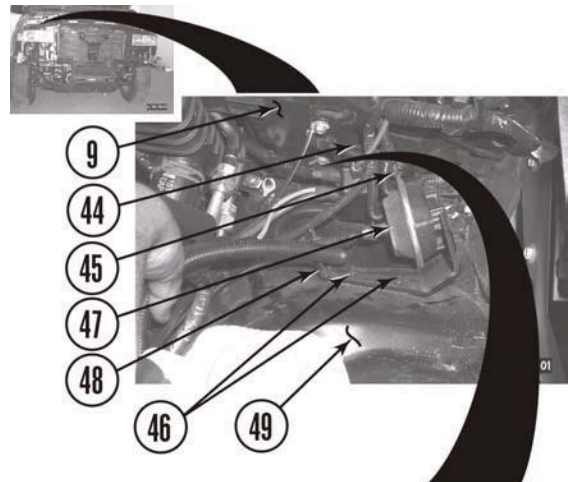

- k. Remove clip (50) and wire harness (51) from frame (19) passenger side.

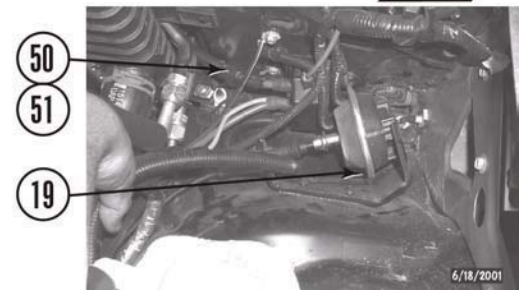

- l. Remove four screws (52) and loosen air filter housing cover (53) from air filter housing (54).

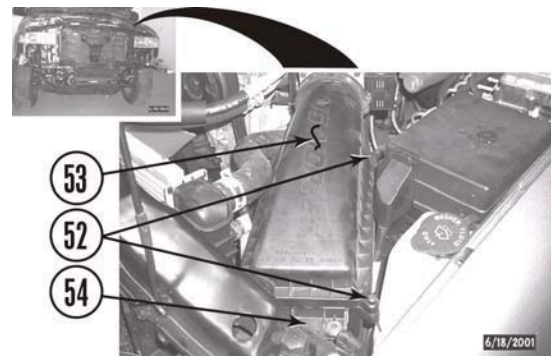

- m. Remove two wire clips (55), wire harnesses (56), wire harness clamp (57), and hose (58) from air intake housing (59).
- n. Remove thumb screw (60), air intake housing (59), and air filter housing cover (53) from throttle body (61) and air filter housing (54). Remove air filter (62) from filter housing.

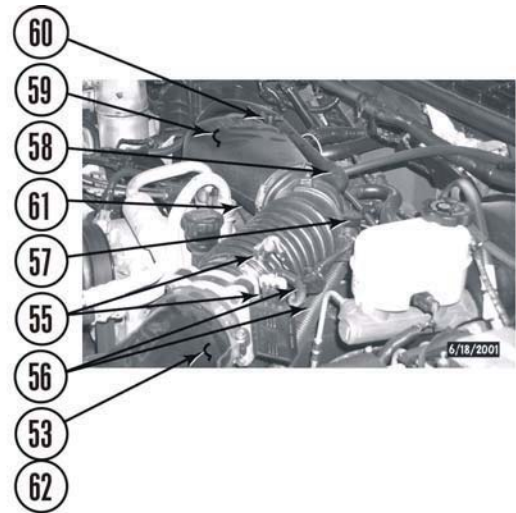

- o. Remove nut (63) and air filter housing (54) from driver side wheel well (64).

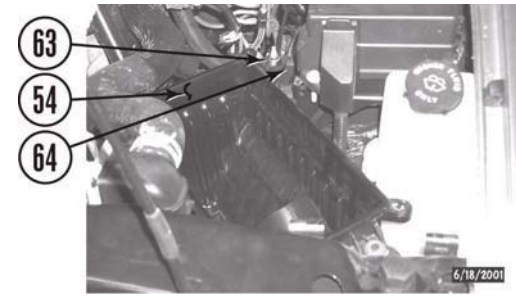

- p. Remove nut (65) and ground strap (66) from fire-wall (67).

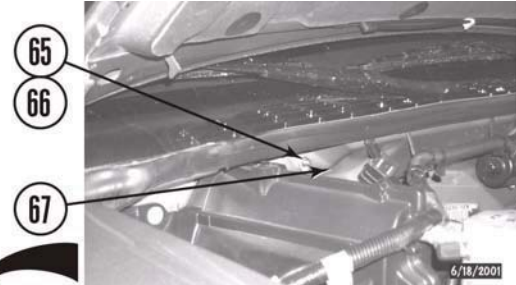

- q. Remove bolt (68), bracket (69) and wire harness (70) from firewall (71).

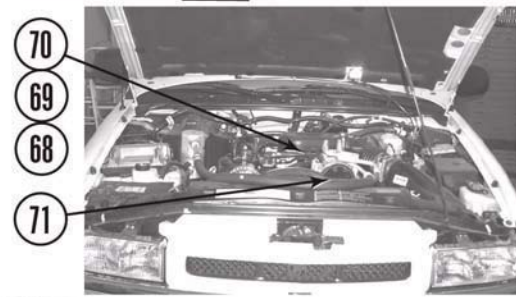

4. Along the frame rails.

- a. Remove bolt (72), clip (73), and three brake lines (74) from driver side shock mount (75).

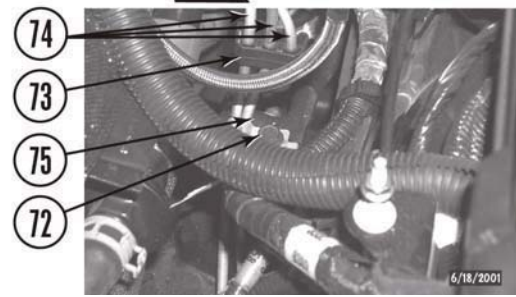

- b. Remove push clip (76) and brake line (77) from frame (19) driver side.

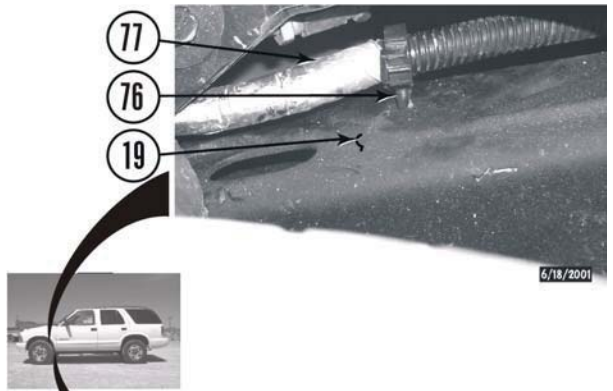

- c. Remove plastic block (78) and brake line (79) from frame (19) driver side.

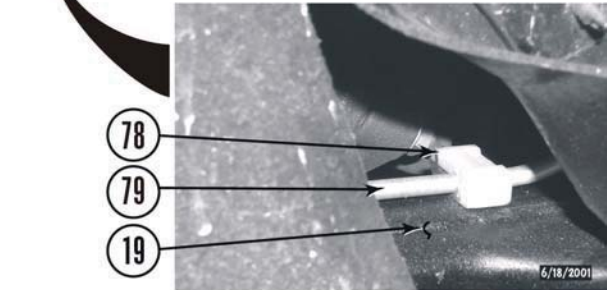

- d. Cut zip tie (80) from wire harness (81) and oil cooler line (82).



- e. Remove clip (83) from two oil cooler lines (82 and 84).



- f. Remove nut (85), two wire loom brackets (86), bolt (87), clamp (88), and two oil cooler lines (82 and 84) from oil pan (89).

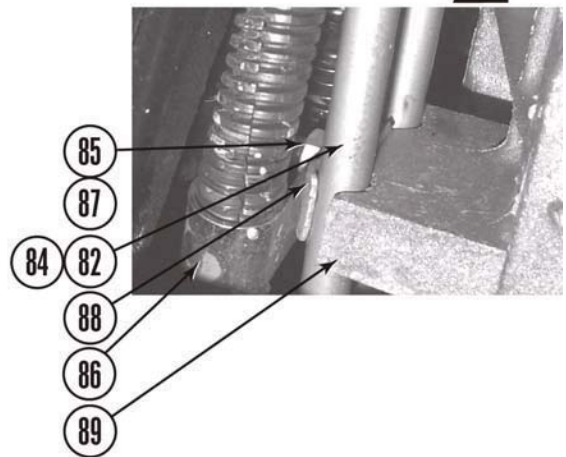

⚠WARNING

Use extreme caution when working near fuel lines and fuel tank. Clean up spilled fuel immediately. Any spark could cause an explosion or fire resulting in serious personal injury and property damage.

5. Fuel filler.

- a. Remove gas cap (90), three screws (91) and fuel filler (92) from body (89).
- b. For pre-2001 vehicles, remove bolt (93) and ground strap (94) from frame (19).

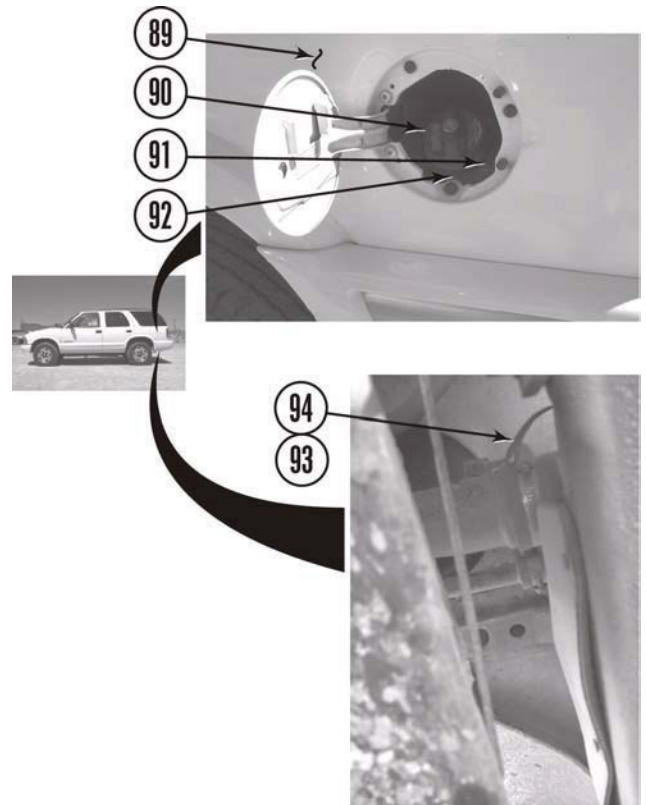

6. Rear bumper.

- a. Measure distance from the tailgate (95) to the rear bumper (96). Record measurement.
- b. Remove screws (97) and license plate (98) from rear bumper (96).
- c. Remove eight nuts with captive washers (99) and four double stud fasteners (100) (six nuts and bolts for pre-2001 vehicles) from two rear bumper brackets (101) and frame (19).

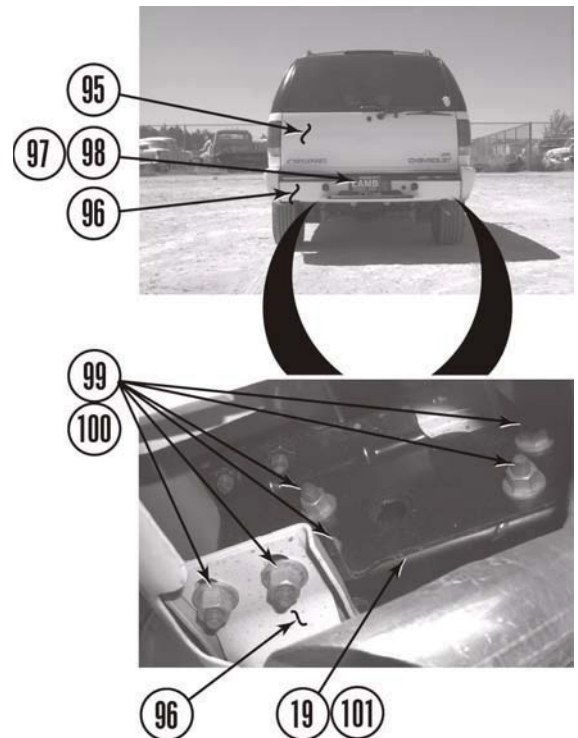

- d. Pull rear bumper (96) away from frame (19) and remove two license plate lights (102), three clamps (103) and wire harness (104) (pre-2001 vehicles may have a different number of clamps). Remove rear bumper and rear bumper brackets (101) from frame.
- e. Squeeze clips and remove plastic cover (105) from rear bumper (96).

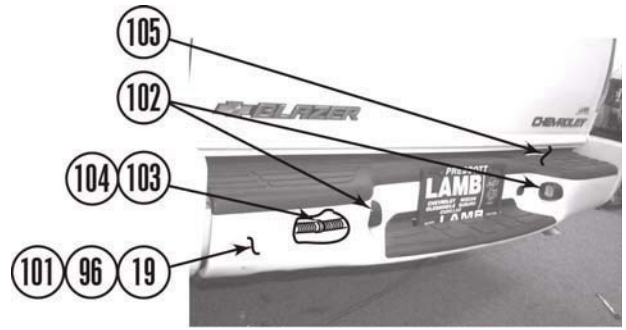

- f. Remove four nuts with captive washers (99), two double stud fasteners (100), four bolts (106), and two rear bumper brackets (101) from rear bumper (96).

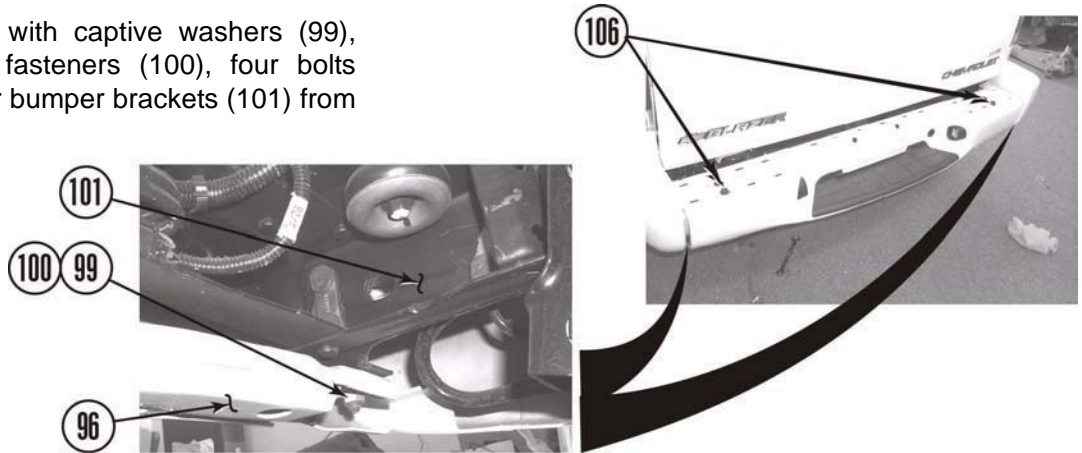

C. Install the kit.

1. Prepare to lift body from frame.

⚠WARNING

Failure to replace the OEM body mounting hardware (except mounting bolts in the kit) in the stock locations could result in serious personal injury or damage to the vehicle.

- a. Hold two core support bolts with captive washers (106) and loosen but do not remove two nuts (107).
- b. Loosen but do not remove ten body mounting bolts (106) (eight body mounting bolts for pre-2001 vehicles).

⚠WARNING

Use extreme caution when lifting body from frame. Ensure lifting device is securely placed. Keep hands out from between frame and body, or serious personal injury could result.

⚠CAUTION

Continually check hoses, wires, lines, etc. to be sure that everything is flexing properly and not binding, or damage to the vehicle could result. Be especially careful of the a/c hoses at the fire wall, the belt pulley, and at the core support. Ensure brake lines stretch while lifting. Bending the lines to gain ample slack may be necessary. Be extremely careful not to kink the lines.

⚠NOTE

Ensure stock spacers and body mounting pads stay on vehicle unless otherwise specified in these instructions. *Kit* spacer blocks are installed in addition to the stock spacers and body mounting pads.

- c. Remove nut (107), bottom bushing retaining cup (108), bottom bushing (109), and bolt with captive washer (106) from frame mounting pad (110), top bushing (111), top bushing retaining cup (112), and core support (9).
- d. Remove five passenger side body bolts (106), bottom bushing retaining cups (108), and bottom bushings (109) from frame mounting pads (110), top bushing (111), top bushing retaining cup (112), and body (89) floor.

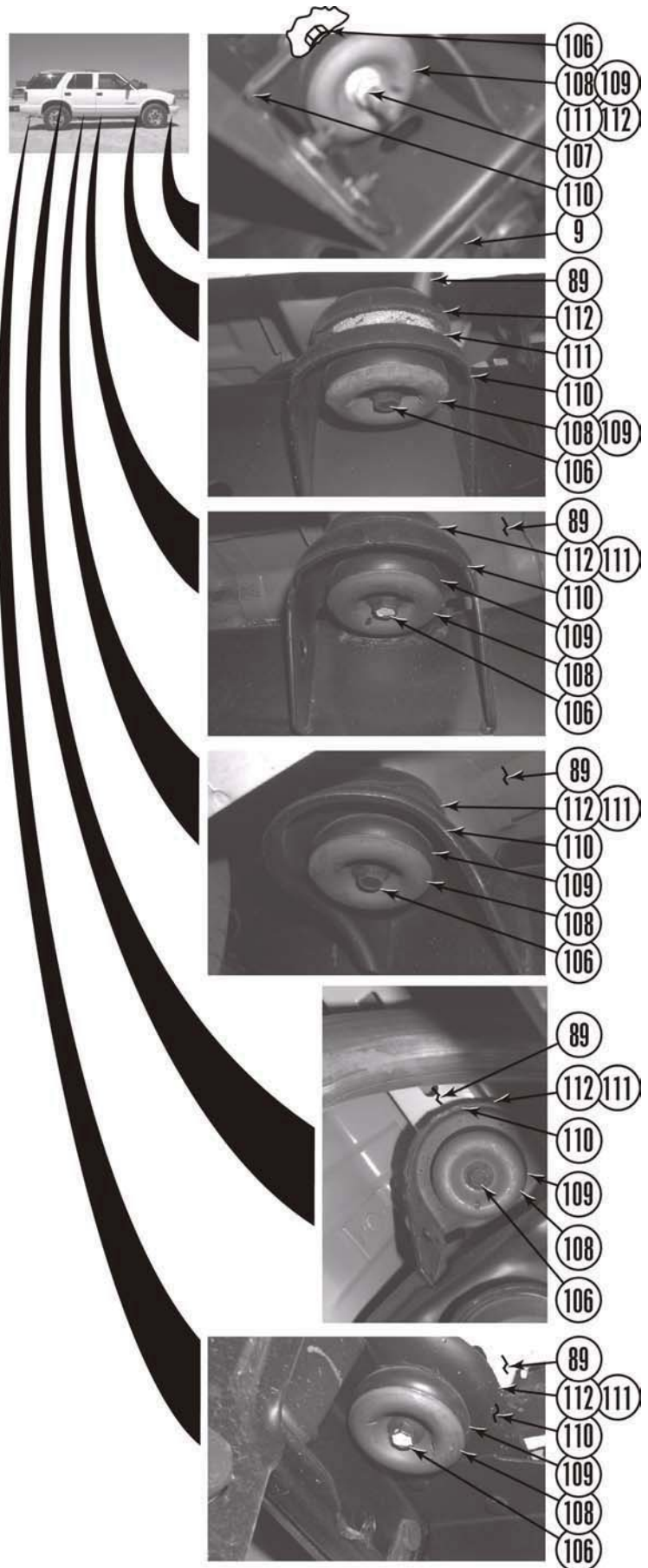

⚠WARNING

Continually check hoses, wires, lines, etc. to be sure that everything is flexing properly and not binding, or damage to the vehicle could result. **Be especially careful of the ABS lines on top of the driver side wheel well. Bending the lines a little at a time while lifting may be necessary. Be extremely careful not to kink the lines.**

2. Lift body and install body passenger side *kit* spacer blocks.
 - a. Using a hydraulic jack and a wooden block, slowly lift body (89) passenger side just high enough to position *kit* 2" x 3" spacer block (113) between top bushing retaining cup (112) and core support (9).
 - b. Position six *kit* 2" x 3" spacer blocks (113) on top of the passenger side top bushing retaining cups (112).
 - c. Install a *kit* 12mm x 140mm bolt (114) through *kit* 7/16" USS washer (115), core support (9), *kit* spacer block (113), top bushing retaining cup (112), top bushing (111), frame mounting pad (110), bottom bushing (109), bottom bushing retaining cup (108), and nut (107). Do not tighten.
 - d. Install five *kit* 12mm x 140mm bolts (114) through three *kit* 7/16" USS washers (115), bottom bushing retaining cups (108), bottom bushings (109), frame mounting pads (110), top bushings (111), top bushing retaining cups (112), *kit* spacer blocks (113), and body (89) floor. Do not tighten.
 - e. Lower body (89) onto *kit* spacer blocks (113).

3. Install the body driver side spacer blocks.
 - a. Repeat steps C.2.a. through C.2.e. for the body driver side.
4. Finish the body spacer block installation.
 - a. Remove twelve *kit* bolts (114) one at a time, coat threads with Loctite®, and reinstall. Tighten until bottom bushing retaining cup bottoms out.

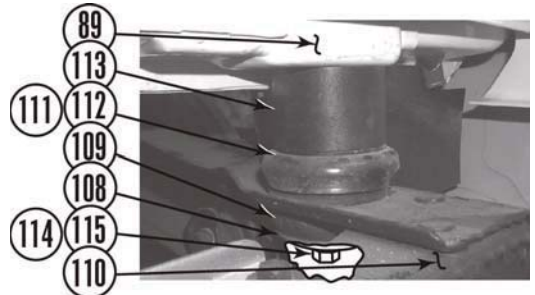
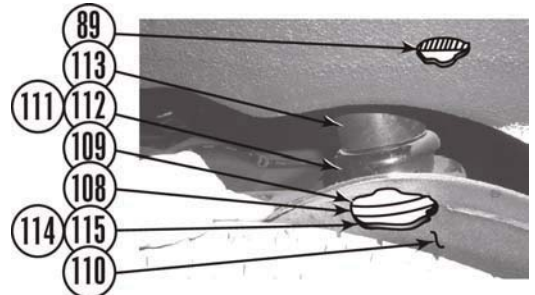
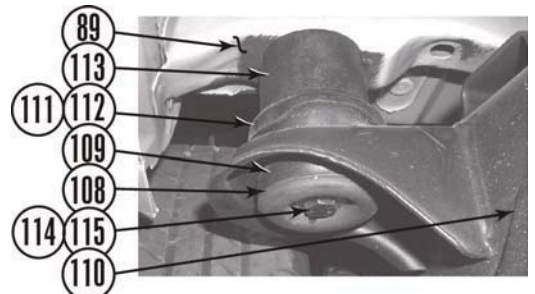
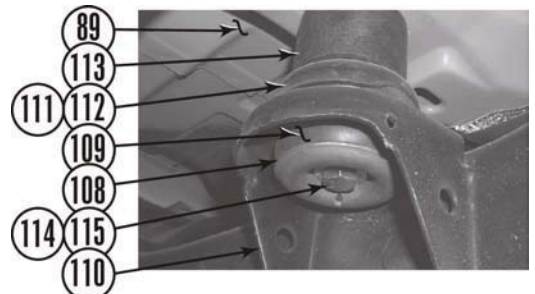
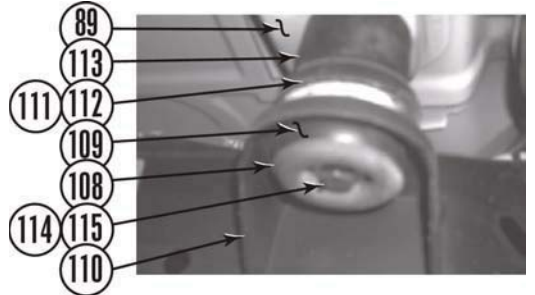
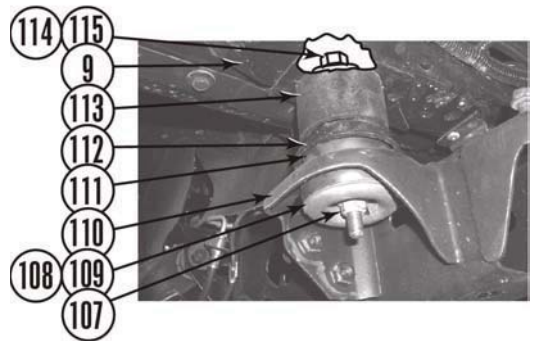

5. Fuel lines.

⚠WARNING

Use extreme caution when working near fuel lines and fuel tank. Clean up spilled fuel immediately. Any spark could cause an explosion or fire resulting in serious personal injury and property damage.

⚠NOTE

Steps a. through f. below are for pre-2001 vehicles. 2001 up vehicles skip these steps.

- a. Loosen three hose clamps (116 and 117) and remove fuel filler (108) from vent hose (118) and fuel hose (119).
- b. Remove fuel filler (108) and vent hose (118) from vehicle.
- c. Cut steel portion of fuel filler (108) neck approximately 2" below vent hose nipple and install *kit* 5" fuel extension (120) with two *kit* #36 hose clamps (121). Do not tighten.
- d. Install fuel filler (108) on body (89) with three screws (91). Install gas cap (90) on fuel filler.
- e. Install *kit* vent hose (122) with two *kit* #10 hose clamps (123).
- f. For pre-2001 vehicles, install ground strap (94) on frame (19) with bolt (93).

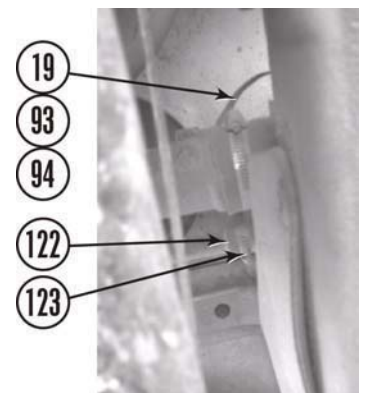
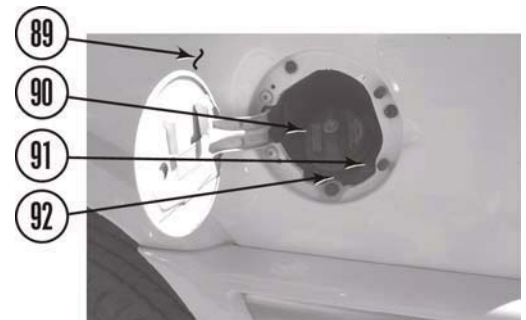
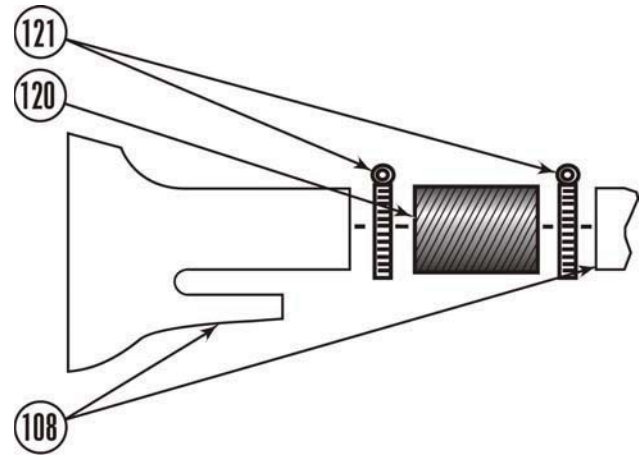
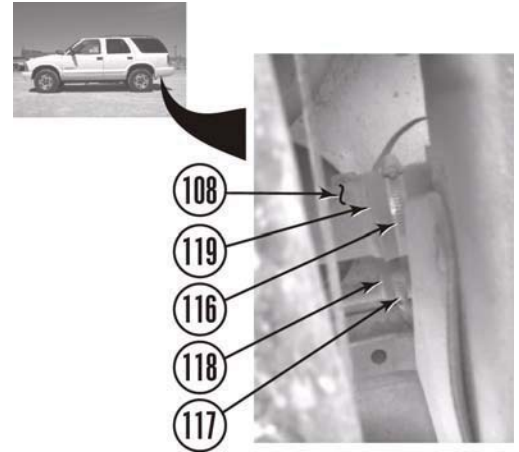

⚠WARNING

The following procedure is intended only to enhance the appearance of the vehicle. The rear bumper will no longer be rated for towing of any kind. Towing with the rear bumper after it has been lifted can result in death, serious personal injury, or damage to the vehicle. Towing after the bumper has been lifted should be accomplished using a rated Class III receiver type hitch.

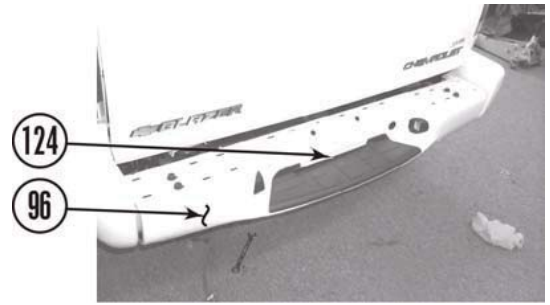

6. Install the rear bumper.
 - a. Squeeze clips and remove small plastic bumper cover (124) from rear bumper (96).
 - b. Trim inside of rear bumper (96) in two places as shown. Test fit bumper to ensure that enough material has been removed.

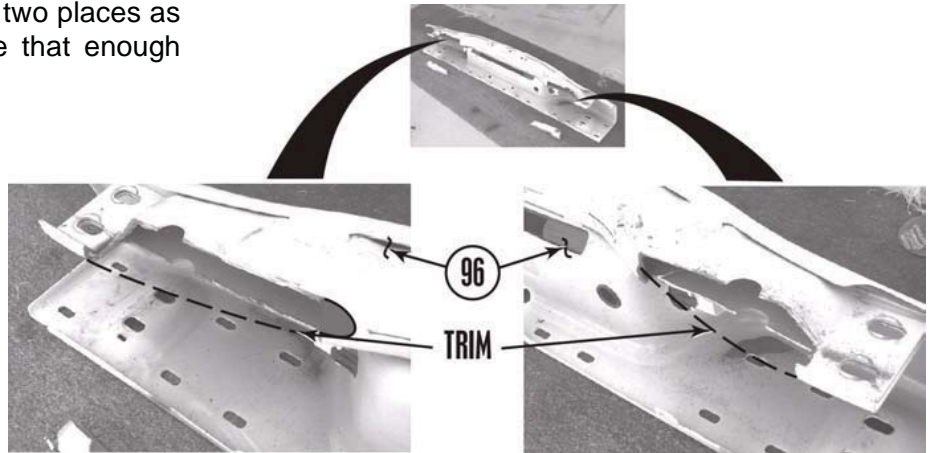

- c. Install two *kit* rear bumper brackets (125) on rear bumper (96) with two double stud fasteners (100), four nuts with captive washers (99), four *kit* 7/16" x 1" bolts (126), eight *kit* 7/16" USS washers (127), and four *kit* 7/16" x 1" nylock nuts (128). Do not tighten.

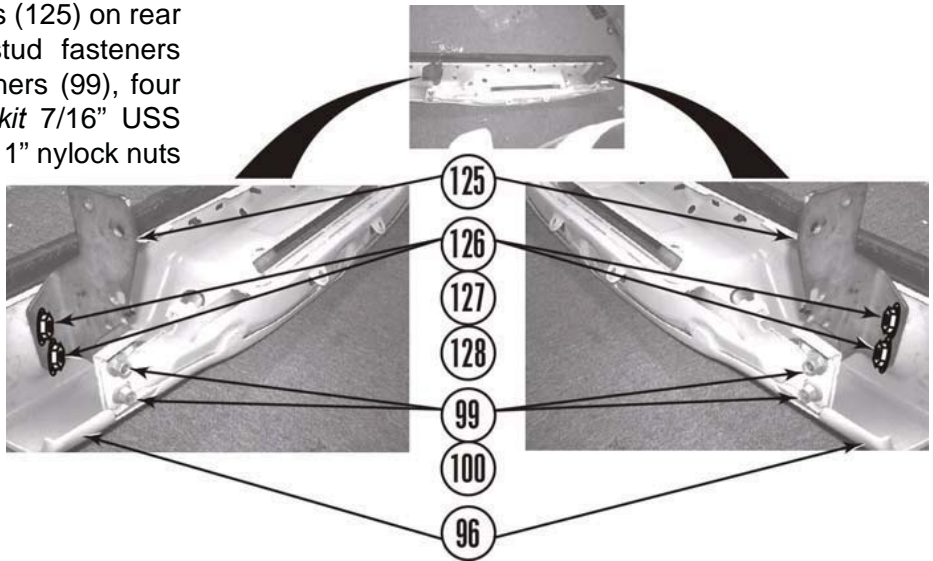

- d. Loosely position two *kit* rear bumper brackets (125) and rear bumper (96) on frame (19) and install two license plate lights (82), three clamps (103) and harness (104) on rear bumper.

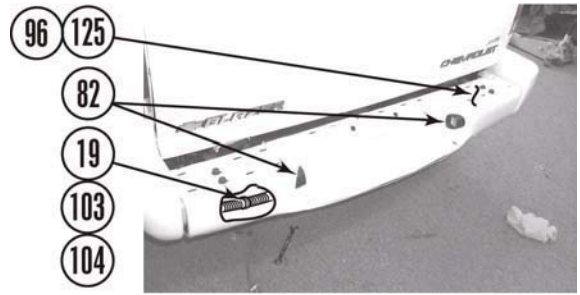

- e. Install two *kit* rear bumper brackets (125) on frame (19) with two double stud fasteners (100), four nuts with captive washers (99), four *kit* 7/16" x 1 1/2" bolts (129), eight *kit* 7/16" USS washers (127), and four *kit* 7/16" nylock nuts (128). Do not tighten.

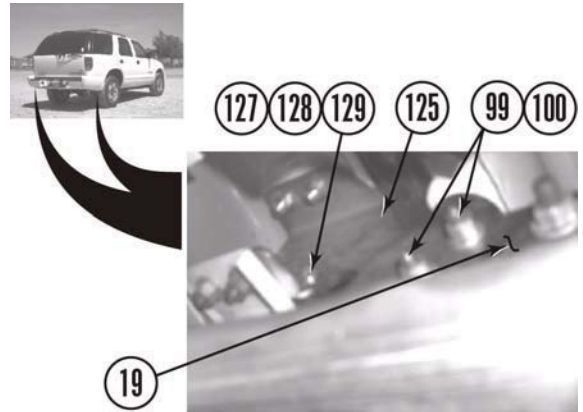

- f. Adjust rear bumper (96) to tailgate (95) clearance using measurements taken in step B.6.a. Tighten nuts (99 and 128) and bolts (126 and 129) to 55 lb-ft.



- g. Using a 7/8" hole saw, drill a spare tire winch access hole in the rear bumper as shown.

- h. Install plastic two plastic bumper covers (105 and 124) on bumper (96).

- i. Install license plate (98) on rear bumper (96) with screws (97).



7. Along the frame rails.

- a. If possible, install plastic block (78) and brake line (79) on frame (19).

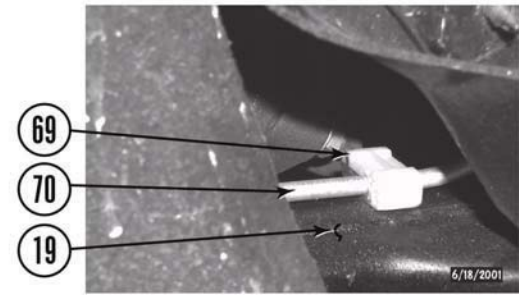

- b. If possible, install push clip (76) and brake line (77) on frame (19).

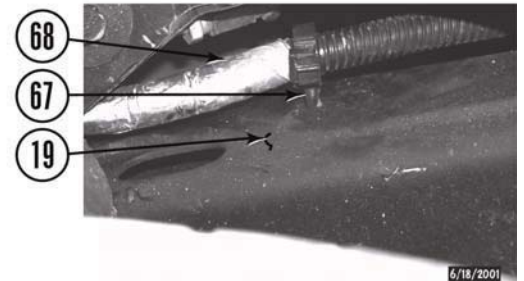

8. Under the hood.

NOTE

Steps 8.a. through 8.d. may not be necessary for 2001 - 2002 vehicles if the battery cables easily reach the battery.

- a. Drill two 1/8" holes in core support (9) 1/2" toward center of vehicle from old holes as shown. Install bracket (44) on core support with two sheet metal screws (45) in the new holes.

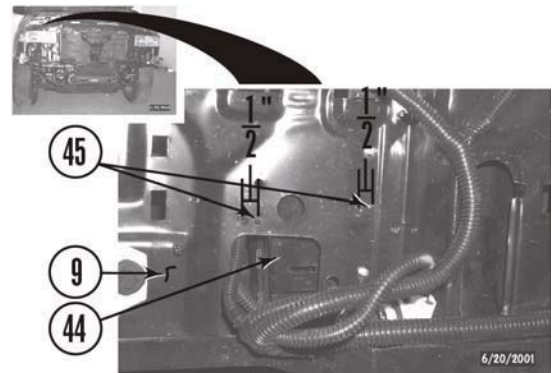

- b. Install positive battery cable box (43) on bracket (44).

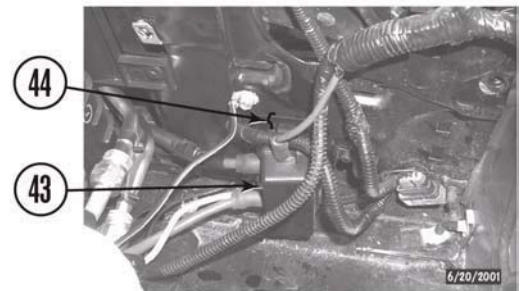

- c. Drill two 13/32" holes in wheel well (49) 1/2" toward center of vehicle from old holes as shown.

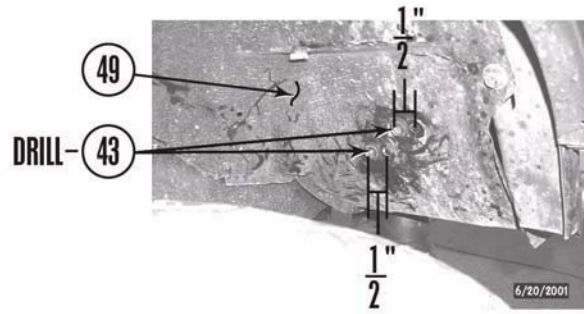

- d. Install differential actuator (47) and bracket (48) on wheel well (49) with two bolts with captive washers (46).

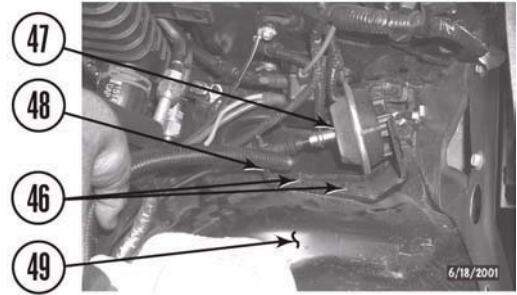

- e. If electrical ground strap (39) was removed in step B.3.e., install electrical ground strap on *kit* ground bracket (130) with *kit* 1/4" x 1" bolt (131), two *kit* 1/4" SAE washers (132), and *kit* 1/4" nylock nut (133).

- f. Install *kit* ground bracket (130) on frame (19) with bolt (40).

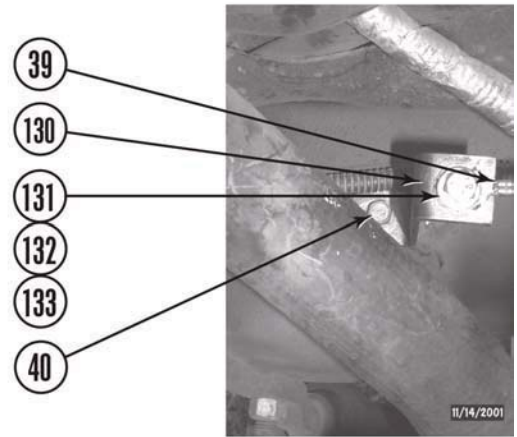

- g. Install battery tray (38) on core support (9) with two bolts with captive washers (41).

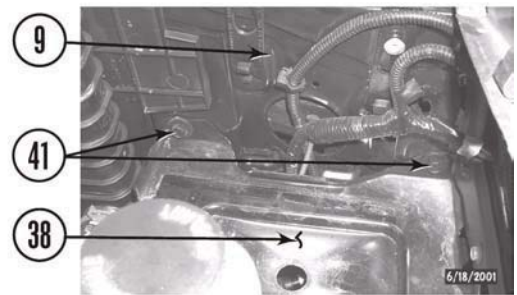

- h. Install battery (3) on battery tray (38) with battery hold down (37) and nut (36).

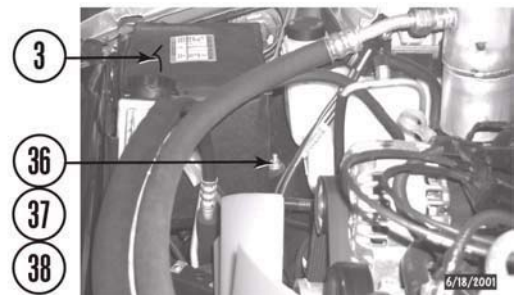

- i. Install wire harness (70) and bracket (69) on firewall (71) with bolt (68). Ensure attached vacuum hoses are not stretched too tight.

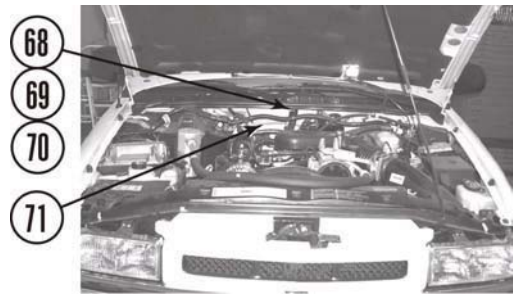

- j. Install *kit* bracket (134) on firewall (71) with nut (65).
- k. Install ground strap (66) on *kit* bracket (134) with *kit* 1/4" washer (132) and *kit* 1/4" nylock nut (133).

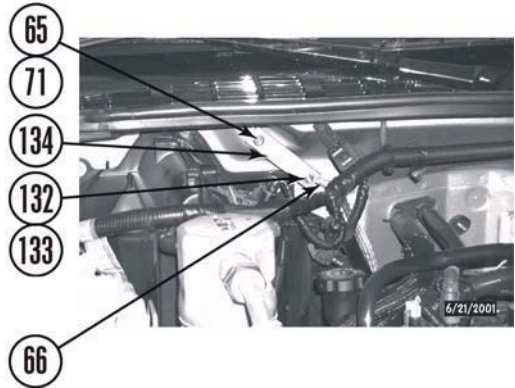

- l. Install air filter housing (54) on wheel well (64) with nut (63).

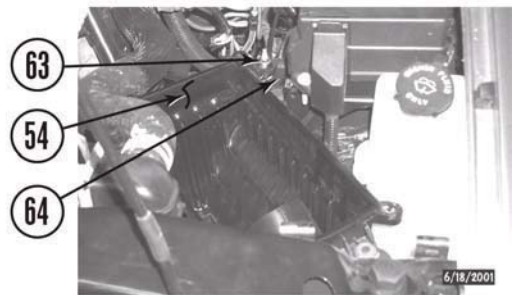

- m. Install air filter (62) in air filter housing (54). Install air filter housing cover (53) on air filter housing with four screws (52).



- n. Install air intake housing (59) on throttle body (61) with thumb screw (60).

- o. Install two wire clips (55), wire harnesses (56), wire harness clamp (57), and hose (58) on air intake housing (59).

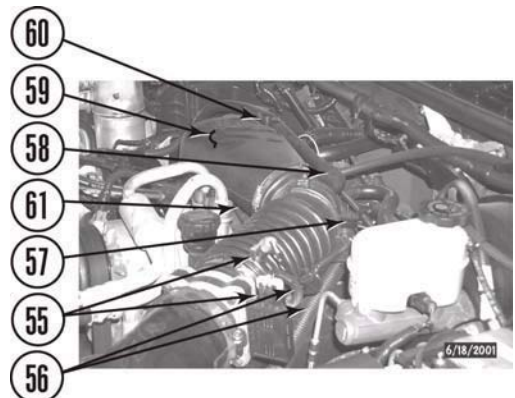

9. Radiator.

- a. Remove four clip nuts (135) from lower fan shroud (34).

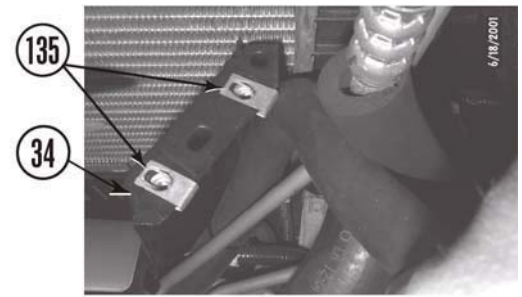

- b. Install upper fan shroud (32) on core support (9) with three bolts with captive washers (33).

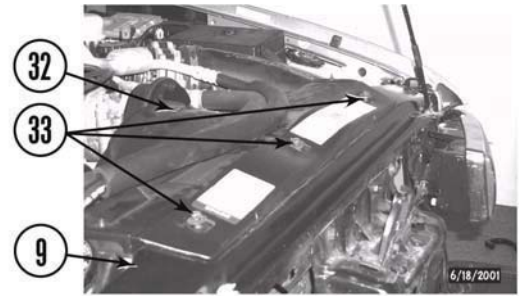

- c. Install upper fan shroud (32) on lower fan shroud (34) with four *kit* 3/8" USS washers (136), four *kit* 3/8" x 3 1/2" bolts (137), four *kit* tubes (138), four *kit* 3/8" USS washers (136), and four *kit* 3/8" nylock nuts (139).

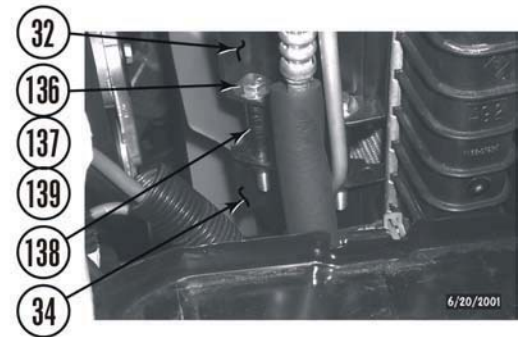

- d. Install *kit* lower fan shroud bracket (140) on lower fan shroud (34) behind middle clip (141).

- e. Using *kit* lower fan shroud bracket (140) as a template mark core support as shown and drill 1/8" hole **through the first of metal only** in core support (9). Install *kit* lower fan shroud bracket on core support with *kit* sheet metal screw (142).

- f. **Four cylinder only** (not pictured) - Install two flexible air duct hoses on air duct on top of radiator with two clamps.

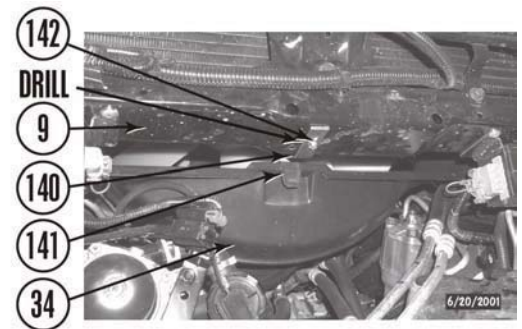

- g. If possible, install bottom oil cooler line (84) in top hole on oil pan (89) and two wire loom brackets (86) in bottom hole on oil pan with clamp (88), nut (85), and bolt (87).
- h. Install *kit* zip tie (143) on bottom oil cooler line (82) and top oil cooler line (84). Ensure hard lines do not contact lower radiator hose (144).

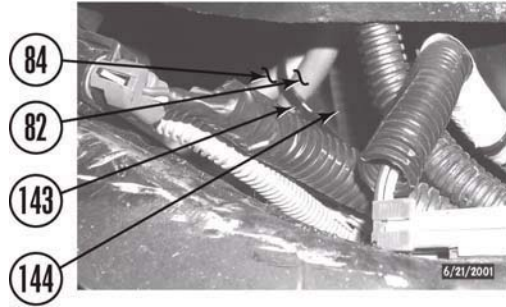
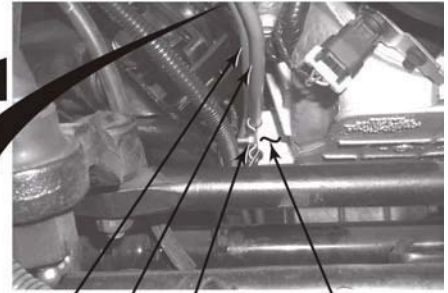

NOTE
2001 up vehicles turn *kit* front oil filter bracket around to install.

- i. Install *kit* front oil filter bracket (145) and *kit* rear oil filter bracket (146) on oil filter bracket (29) with two shoulder bolts (28) (rear oil bracket has notch in top side). Do not tighten.
- j. Install *kit* front oil filter bracket (145) and *kit* rear oil filter bracket (146) on core support (9) with two *kit* 1/2" x 3" shoulder bolts (147), two *kit* 3/8" USS washers (136), and two *kit* 3/8" nylock nuts (139). Tighten nuts (139) and bolts (28 and 147) to 55 lb-ft.
- k. Install plastic cover (27) on frame (19) with six washers (26) and six bolts (25).
- l. Install plastic air scoop (22) on core support (9) with four pull clips (21).

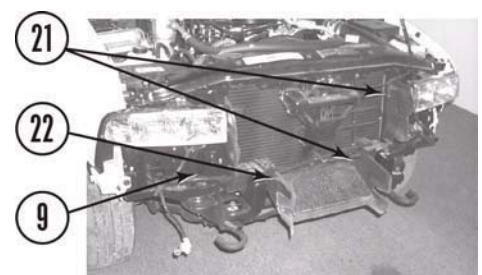
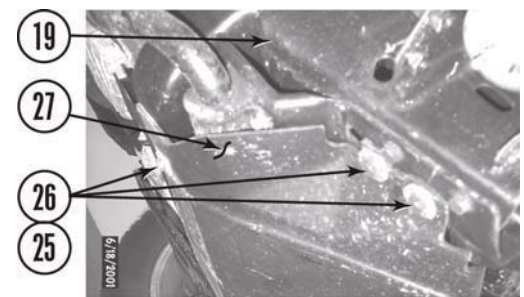
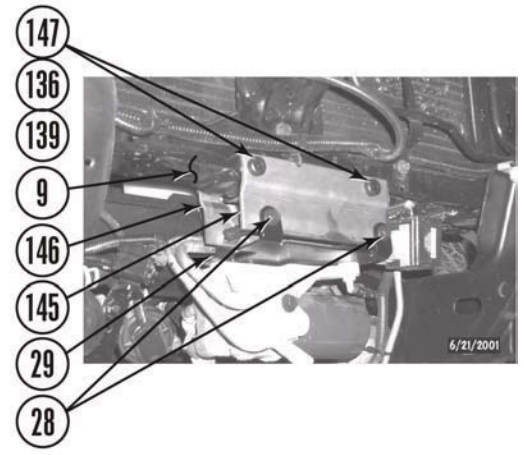

10. Install the front bumper.

- a. For pre-2001 vehicles, you may have to trim valence (148) as shown to accommodate frame. Perform steps 10.b. and 10.c. below and test fit front bumper before trimming.

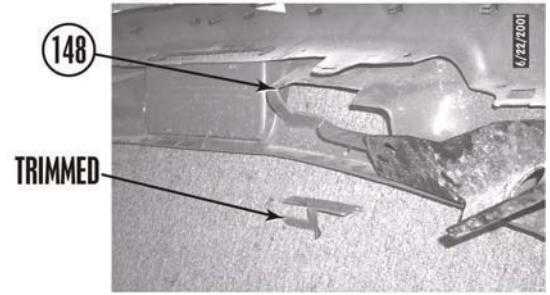

- b. Position four *kit* 2" x 2" spacer blocks (149) on frame (19).

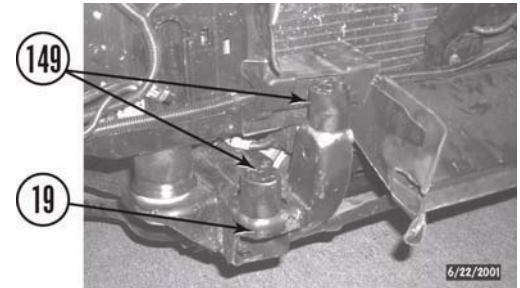

- c. Install front bumper (14) on four *kit* 2" x 2" spacer blocks (149) and frame (19) with four *kit* 3/8" USS washers (136) and *kit* 10mm x 80mm bolts (150). Do not tighten.

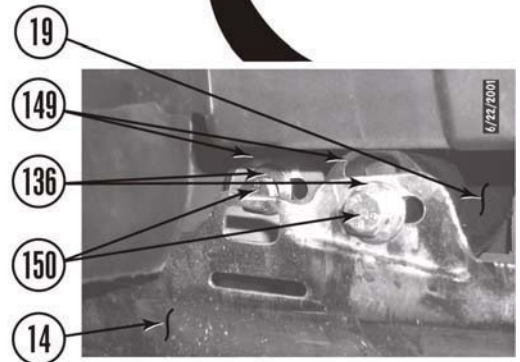

- d. Position two *kit* side front bumper brackets (151) and front bumper side brackets (17) on frame (19) and install four bolts (20). Mark two front bumper side brackets from front as shown.

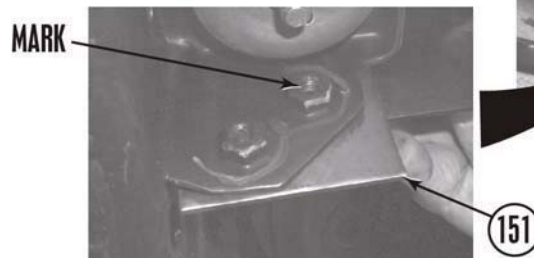
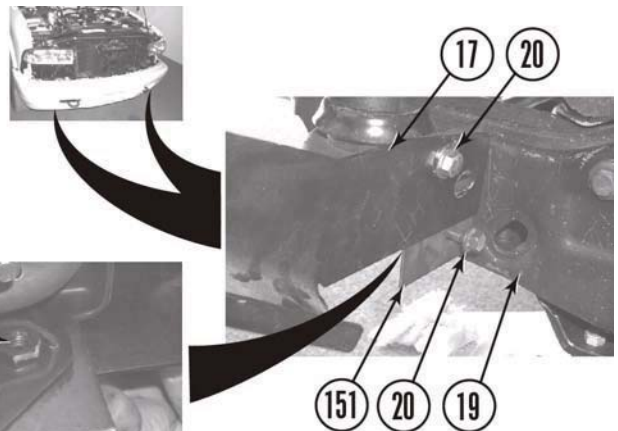

- e. Remove two front bumper side brackets (17) and drill where marked using 13/32" drill bit.



- f. Install two *kit* front bumper side brackets (151) and front bumper side brackets (17) on bumper (14) and frame (19) with six bolts (20), two *kit* 7/16" x 1" bolts (126), four *kit* 7/16" USS washers (127), and two 7/16" nylock nuts (128). Do not tighten.
- g. Adjust front bumper (14) to fender (15) clearance using measurements from step B.2.a. Tighten nuts (128) and bolts (20, 126, 150) to 55 lb-ft.

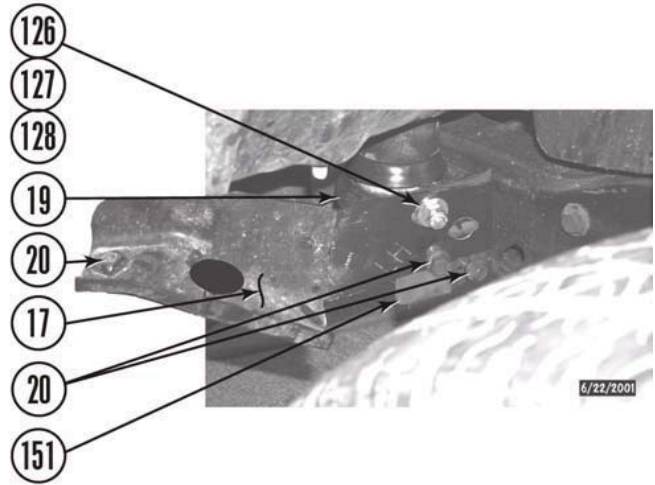

11. Install the grille.

- a. If so equipped, install two wire harness connectors (12) on running lights (13).
- b. Install two turn signal lamps (10) in turn signal housings (11).



- c. Install grille (8) on core support (9) with ten push clips (7).



D. After installation is complete.

1. Install airbag fuse (5) in fuse panel (6). Install cover (4).

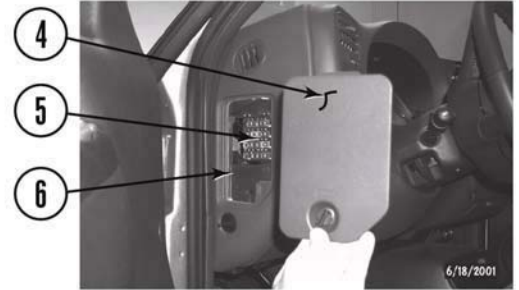

2. Connect both battery cables to the battery (3). Be sure to reconnect the positive cable (2) first, then the negative cable (1).



3. ****Manual transmission only** - Check shift lever operation. If lever does not fully engage in all gears, it may be necessary to notch floorboard or heat and bend gearshift lever.
 - a. If you decide to notch floorboard, remove shift knob, shift boot, and shift console. Notch floorboard in the direction that best improves engagement (usually forward and to the right).
 - b. If you decide to heat and bend gearshift lever, remove shift knob, shift boot, shift console. Remove shift lever from top of transmission.
 - c. Heat lever at a point just above where it is installed and bend in the direction that best improves engagement (usually forward and to the right).
 - d. Reinstall components and check shift lever operation. Ensure that there is proper engagement in all gears.
4. Install Gap Guards (you did remember your Gap Guards, didn't you?).
5. Stick *kit* warning sticker on the dash in plain sight of all vehicle occupants.

1. Double check the vehicle.

⚠CAUTION

Re torque all fasteners after 500 miles and after off road use. All body lift components should be visually inspected and fasteners re torqued during routine vehicle servicing.

- a. Check all mounting hardware to ensure it is properly tightened.
- b. Check all wires, hoses, cables, etc. to ensure they have been properly connected and there is ample slack. With the number of hoses on this vehicle, it is vital that this be checked thoroughly.
- c. Check vehicle electrical system.
- d. Start vehicle and check the steering in both directions to ensure that there is no bind. Check clutch operation. Check the operation of the brake system and the parking brake. Check both shift levers' operation. Ensure that there is proper engagement in all gears and 4 wheel drive ranges.
- e. Test drive vehicle in all gears and 4 wheel drive ranges. Pay close attention to all vehicle systems. Check all hardware again in 500 miles and as part of your regular maintenance schedule.

⚠CAUTION

Performance Accessories does not recommend any particular wheel and tire combinations for use with its body lifts and cannot assume responsibility for the customer's choice of wheels and tires. Reference your owner's manual for recommended tire sizes and warnings related to the use of oversized tires. Larger wheel and tire combinations increase stress and wear on steering and suspension components, which leads to increased maintenance and higher risk for component failure. Larger wheel and tire combinations also alter speedometer calibration, braking effectiveness, center of gravity, and handling characteristics. Consult with an experienced local off road shop to find what wheel and tire combinations work best with your vehicle.

⚠NOTE

All warranty information, instruction sheets, and other documents regarding the installation of this product must be retained by the vehicle owner. Information contained in the instructions and on the warranty card will be required for any warranty claims. The vehicle owner needs to understand the modifications made to his vehicle and how they affect vehicle handling and performance. Failure to provide the customer with this information can result in damage to the vehicle and severe personal injury.

E. Kit Parts List.

Quantity	Description
12	2" x 3" blocks
4	2" x 2" blocks
2	Rear bumper brackets
1	Lower fan shroud support
1	Fuel filler extension, 2" x 5"
1	Vent hose extension, 3/4" x 6"
2	Side bumper brackets
1	Warning to driver sticker
1	Logo sticker
1	6ml bottle Loctite
1	Bolt pack BP152
	Bolts
12	12mm x 140mm bolts
8	7/16" USS washers
6	3/8" USS washers
1	Hardware pack HP152
	Bolts
6	7/16" x 1" bolts
2	7/16" x 1 1/2" bolts
4	10mm x 80mm bolts
2	1/2" x 3" socket shoulder bolts
4	3/8" x 3 1/2" bolts
1	1/4" x 1" bolt
	Washers
3	1/4" SAE washers
4	1/2" USS washers
4	7/16" USS washers
14	3/8" USS washers
	Nuts
2	1/4" nylock nuts
6	7/16" nylock nuts
6	3/8" nylock nuts
	Miscellaneous
1	3" ground strap
1	ground strap (z-shaped)
2	#36 hose clamps
2	# 10 hose clamps
4	2" fan shroud spacer tubes
1	zip tie
1	#12 x 3/4" sheet metal screw
1	Front oil filler bracket
1	Rear oil filler bracket

Copyright 8/02